

If you're having difficulty, our friendly customer team is always here to help.



Cat Tree



EN



## Before You Start

- ⚠ Please read all instructions carefully.
- ⚠ Retain instructions for future reference.
- ⚠ Separate and count all parts and hardware.
- ⚠ Read through each step carefully and follow the proper order.
- ⚠ We recommend that, where possible, all items are assembled near to the area in which they will be placed in use, to avoid moving the product unnecessarily once assembled.
- ⚠ Always place the product on a flat, steady and stable surface.
- ⚠ Keep all small parts and packaging materials for this product away from babies and children as they potentially pose a serious choking hazard.

EN



## Return / Damage Claim Instructions

- ⚠ **DO NOT discard the box / original packaging.**  
In case a return is required, the item must be returned in original box. Without this your return will not be accepted.
- ⚠ **Take a photo of the box markings.**  
A photo of the markings (text) on the side of the box is required in case a part is needed for replacement. This helps our staff identify your product number to ensure you receive the correct parts.
- ⚠ **Take a photo of the damaged part (if applicable).**  
A photo of the damage is always required to file a claim and get your replacement or refund processed quickly. Please make sure you have the box even if it is damaged.
- ⚠ **Send us an email with the images requested.**  
Email us directly from marketplace where your item was purchased with the attached images and a description of your claim.

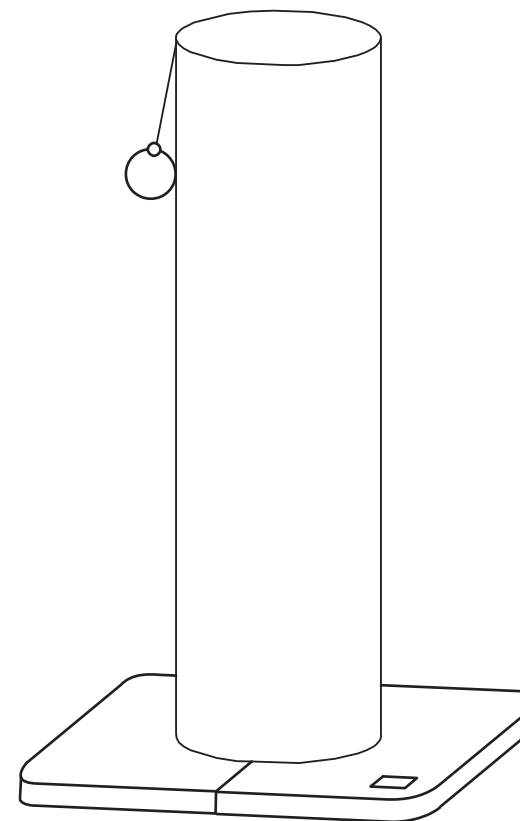

**A** × 1

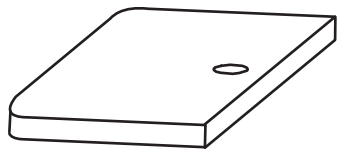

**B** × 1

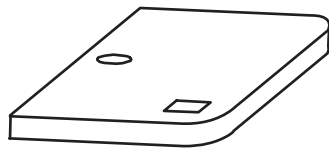

**W1**

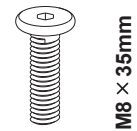

M8 × 35mm

× 2

**W2**



× 2

**P1**

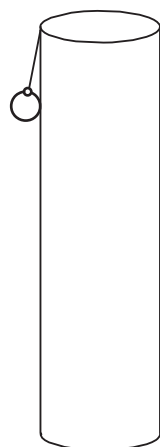

730MM

× 1

**W3**



× 1

**W4**



× 4

1

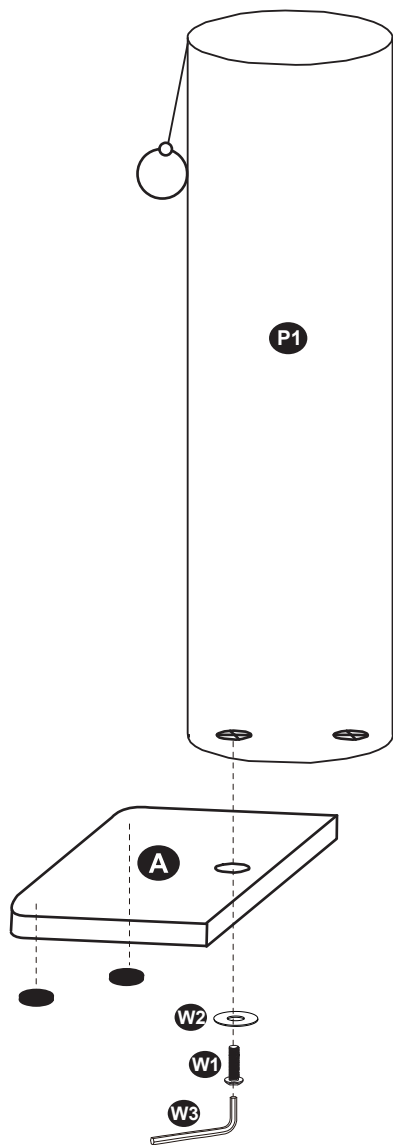

<b>W1</b>		x1
<b>W2</b>		x1
<b>W3</b>		x1
<b>W4</b>		x2

2

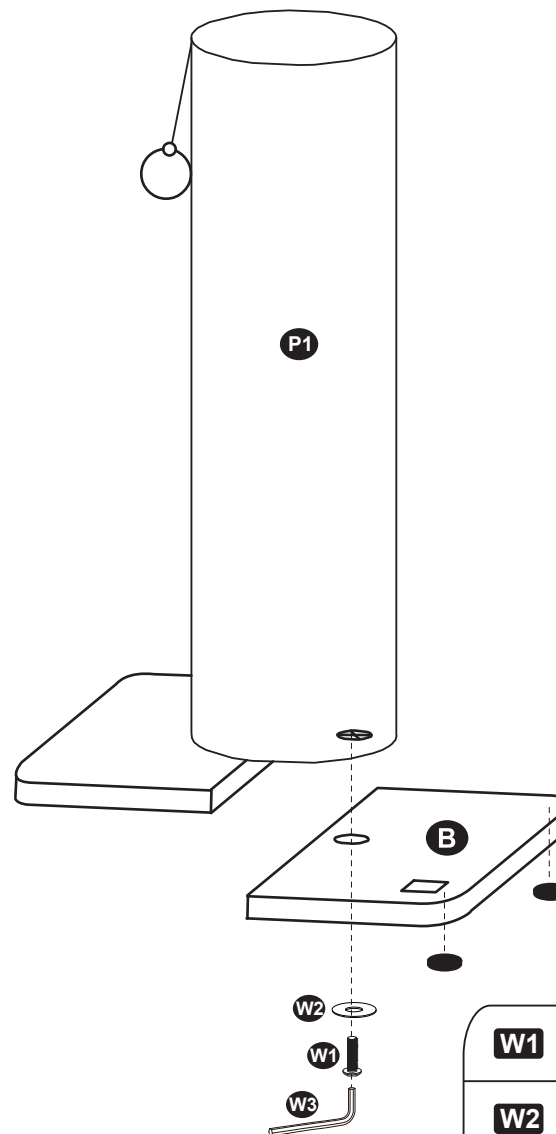

<b>W1</b>		x1
<b>W2</b>		x1
<b>W3</b>		x1
<b>W4</b>		x2