

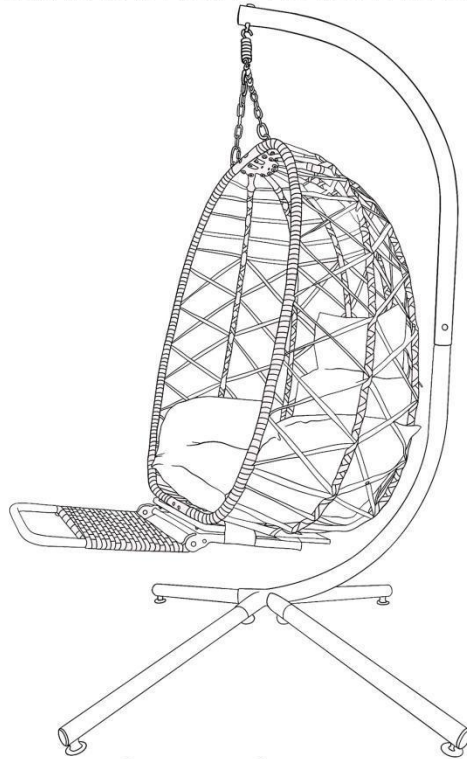









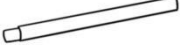
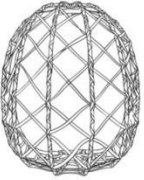



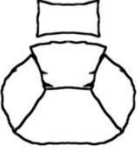

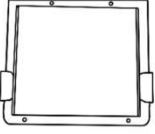
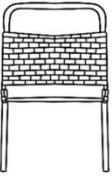
Egg Chair with Footrest

Installation Instructions

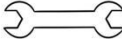
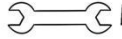

				
A 1	B 1	C 4	D 1	E 1
				 reinforcement
F 1	G 2	H 2	I 1	J 4
				 M-8  M-6
K 1	L 1	M 1	M-8,60mm 1	Hexwrench
 M-8  M-6	 height adjuster			
Wrench	N 4	M-8,20mm 14	M-6,40mm 6	M-6,45mm 2

Step 1:

Screw the 4 height adjusters (N)
into the ends of the 4 support legs (C)

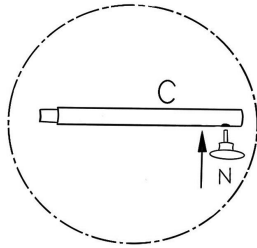

Step 2:

Fasten the 4 support legs (C) to the base
frame (A) with the reinforcements (J)

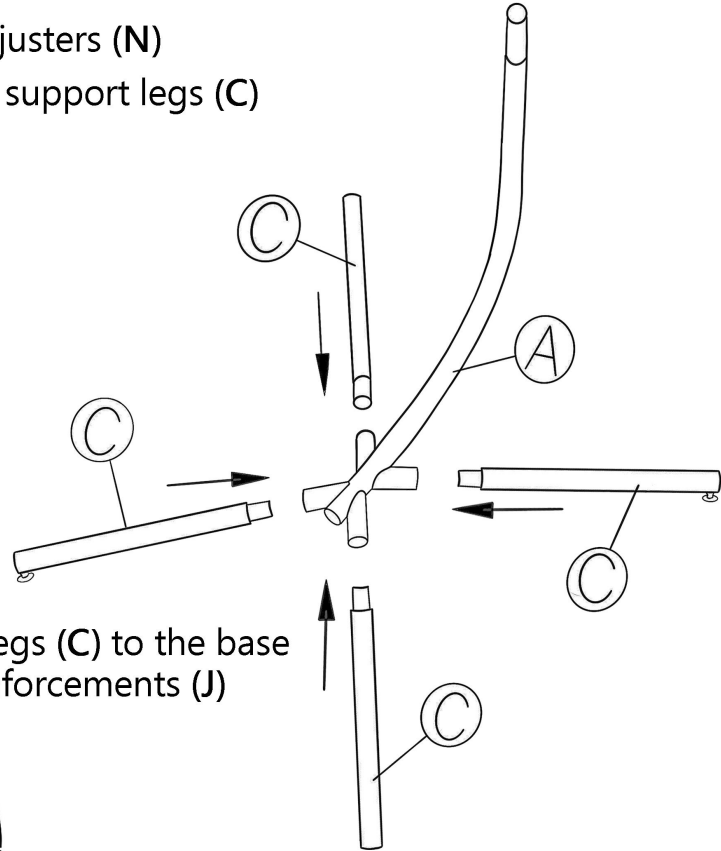
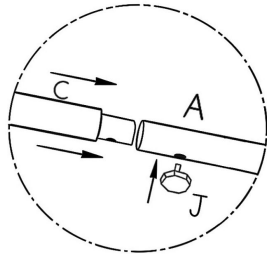

Step 3:

Attach accessories (A) and (B) together using screw-M-8,60mm

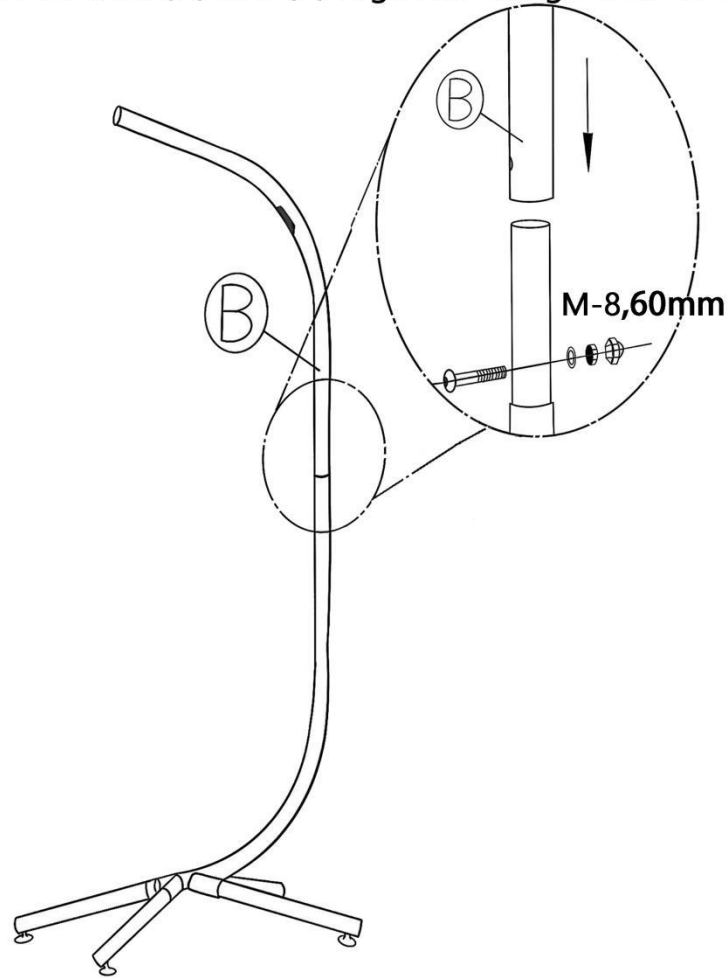

Step:4

Simply flip the chair base (D) over.

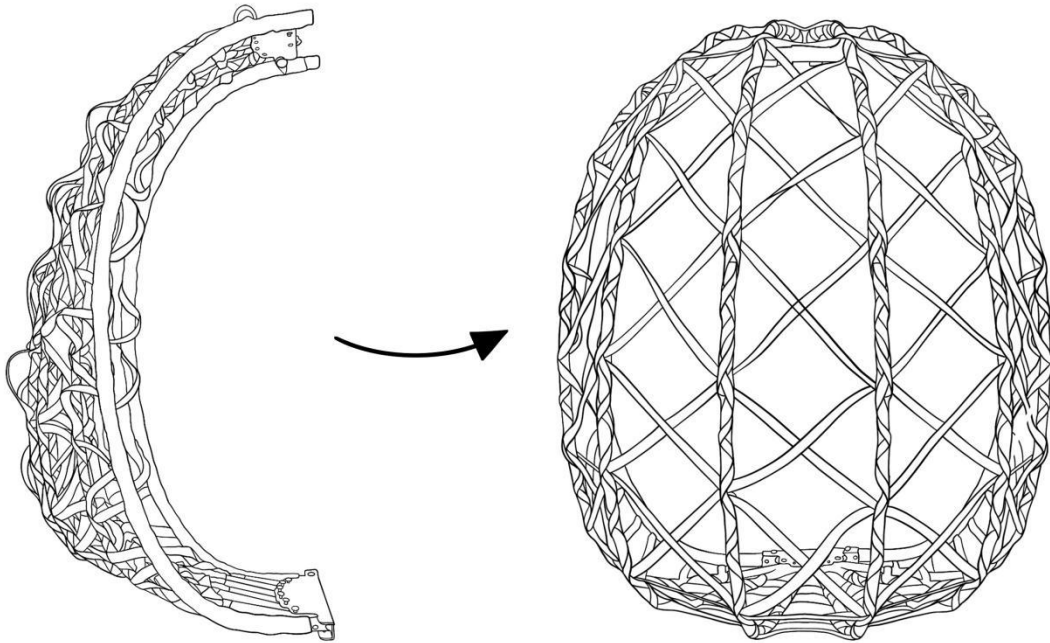

Step:5

Assemble the seat of the chair as shown

--6 (M-8,20mm), 2 (M-6,40mm)

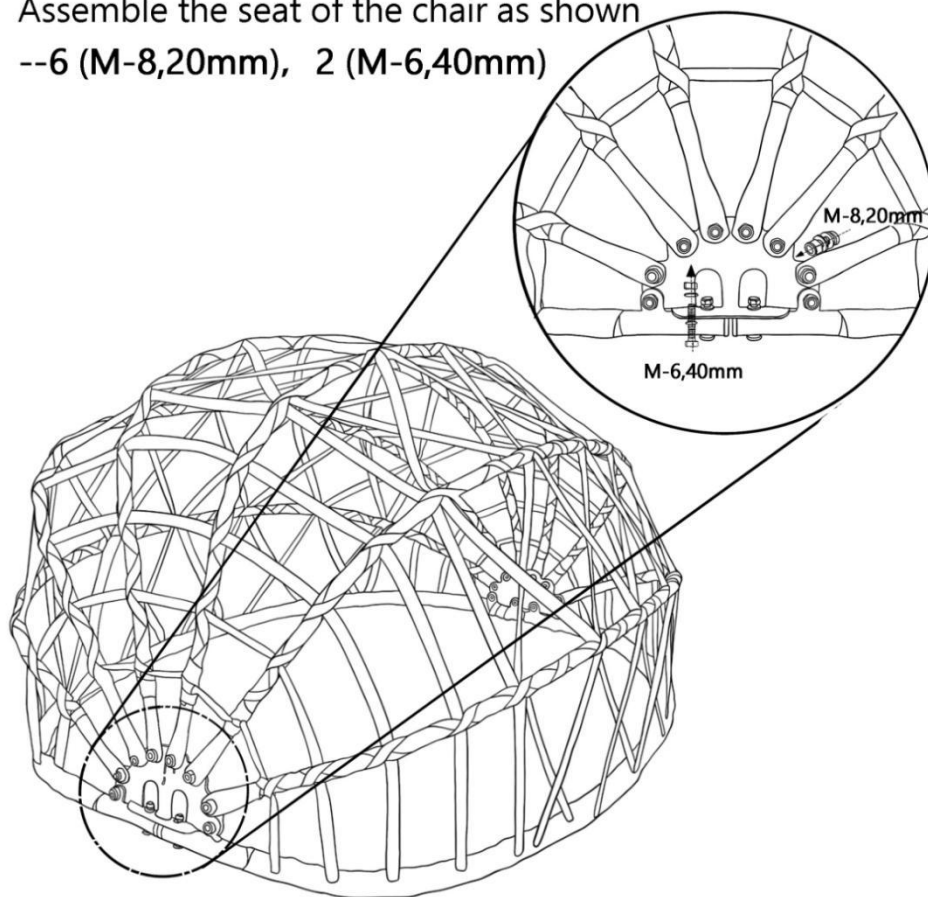

Installation advice: Install the base by placing it on the floor

Step:6

Installation of 6 (M-8,20mm), 2 (M-6,40mm)

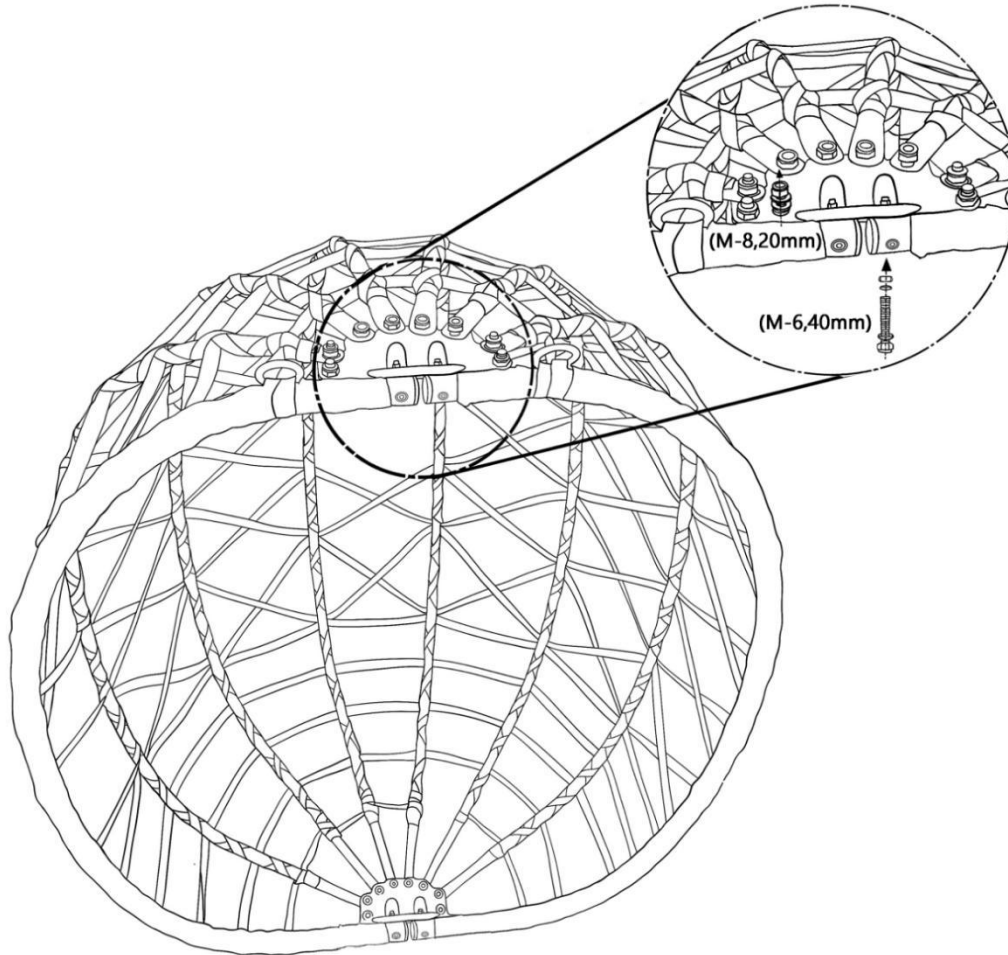

Step:7

Using 2*M6,45mm and 2* M6,40mm to fix part K to the base of the seat.

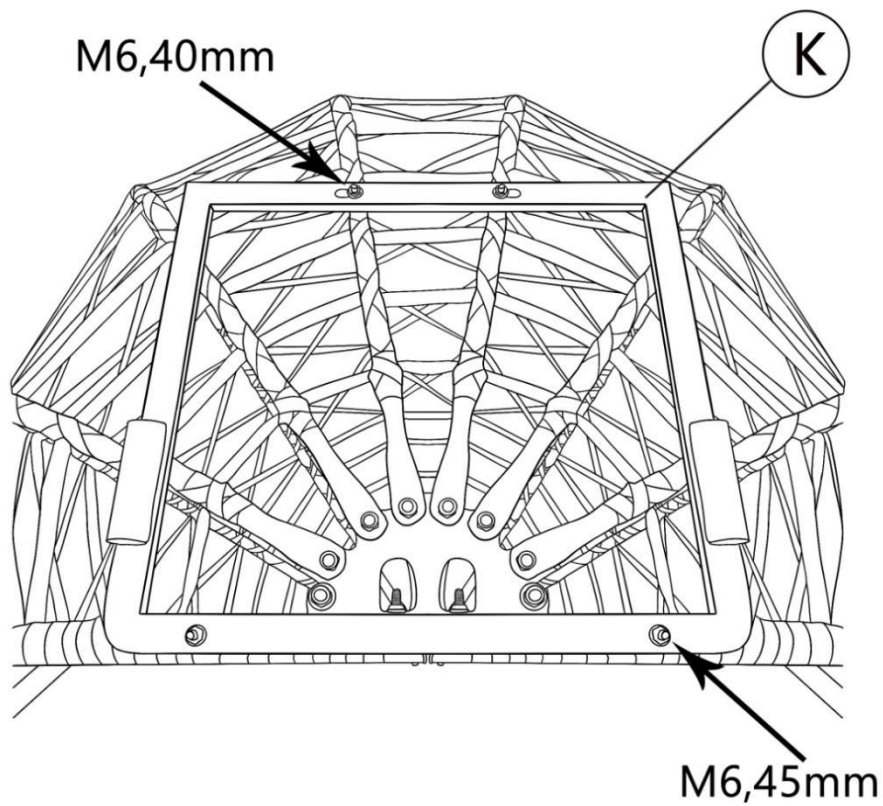

Step:9

Attach the part M to the end of the footrest-K with 2 * M8, 20 mm

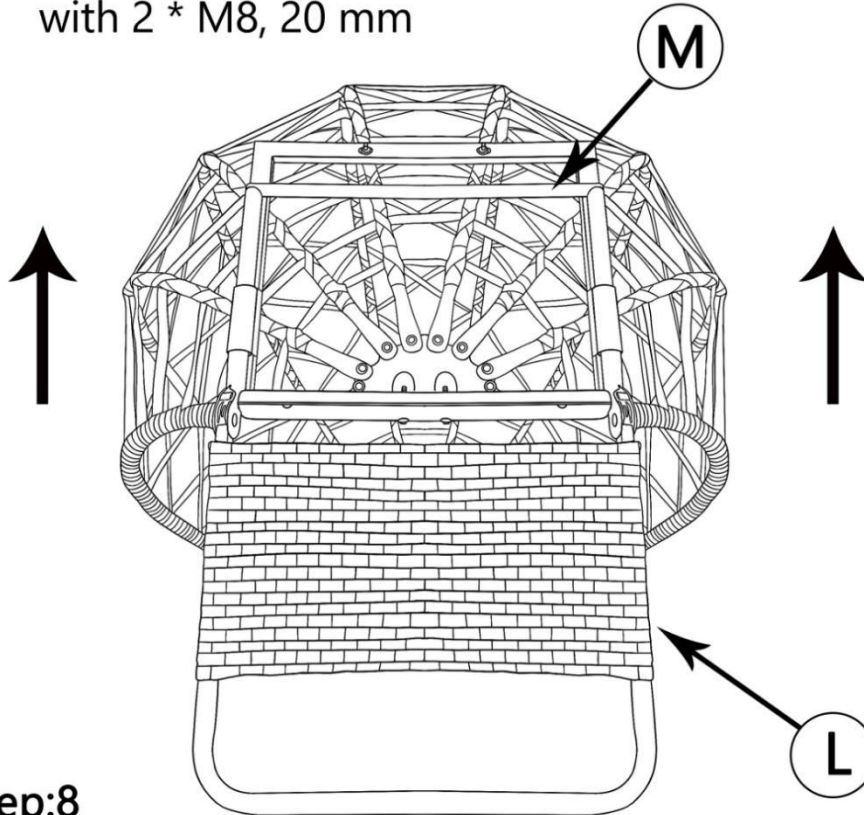

Step:8

Connect the footrest-L to the part K by passing through the two holes in the part K.

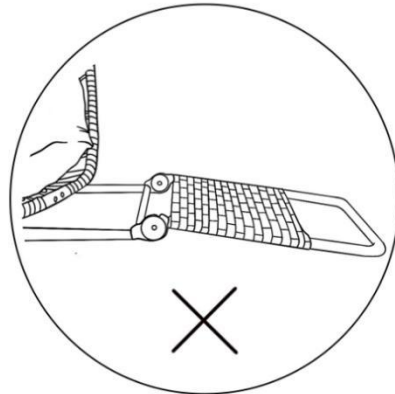
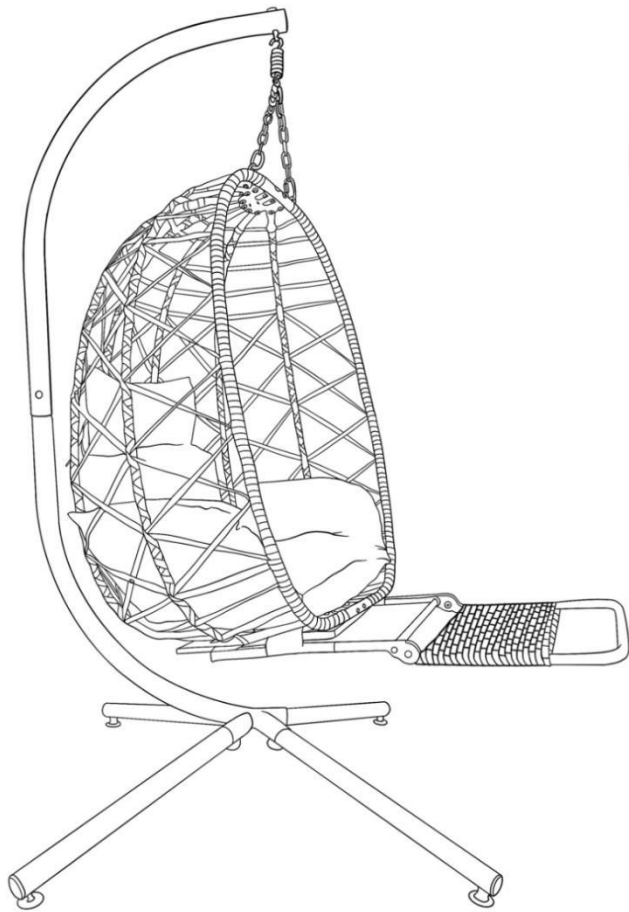

Wrong version
Footrests facing down

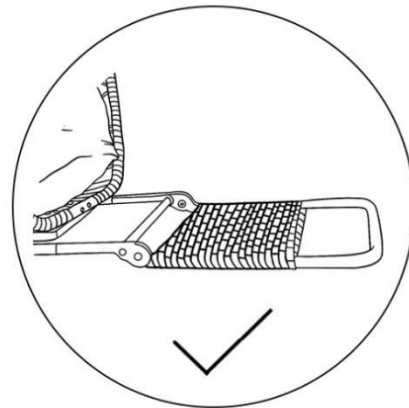

Correct version
Footrests facing up

Step: 10

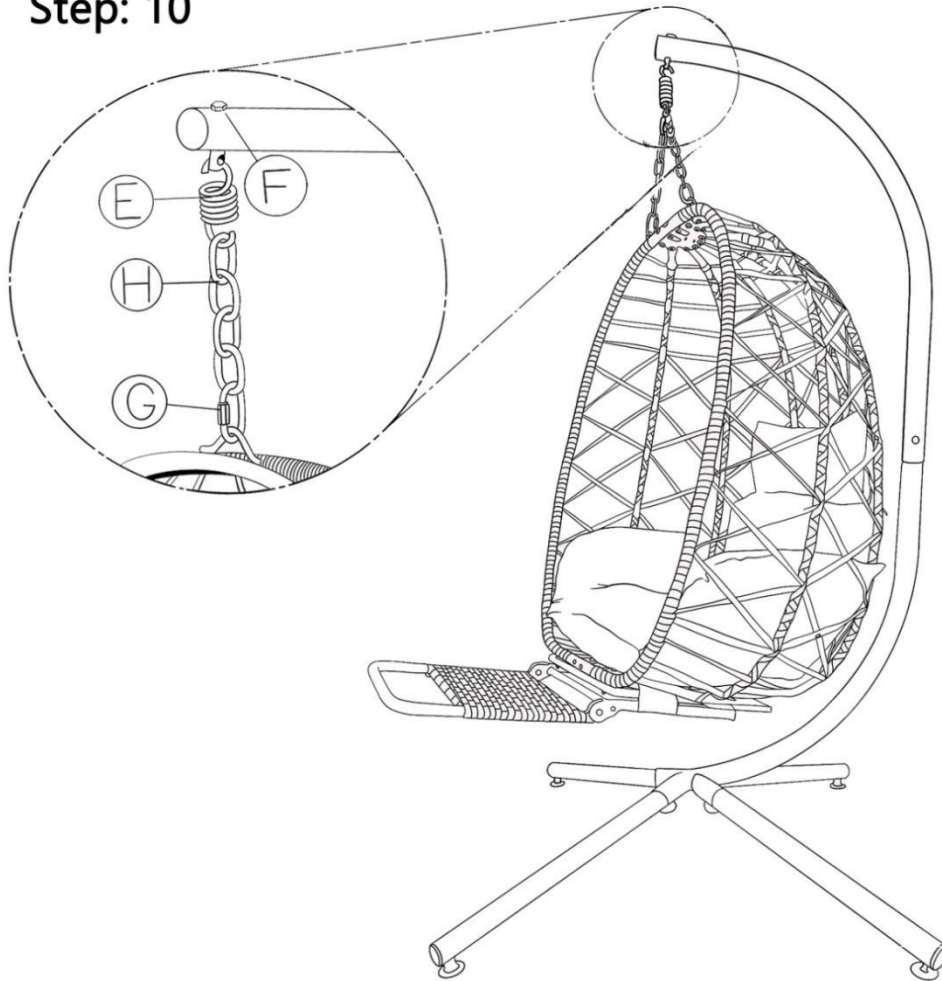

5-speed Adjustable

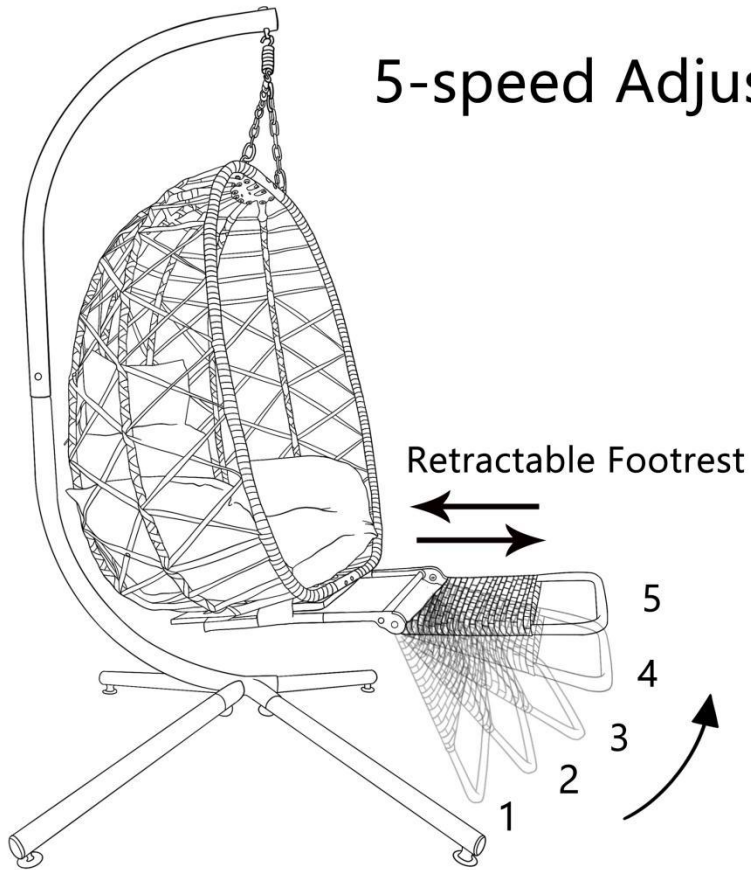

How To Reset The Footrest?

When adjusting to the highest gear, adjust the footrest upwards to unlock the footrest, and adjust it downwards to return to the 4-speed position.

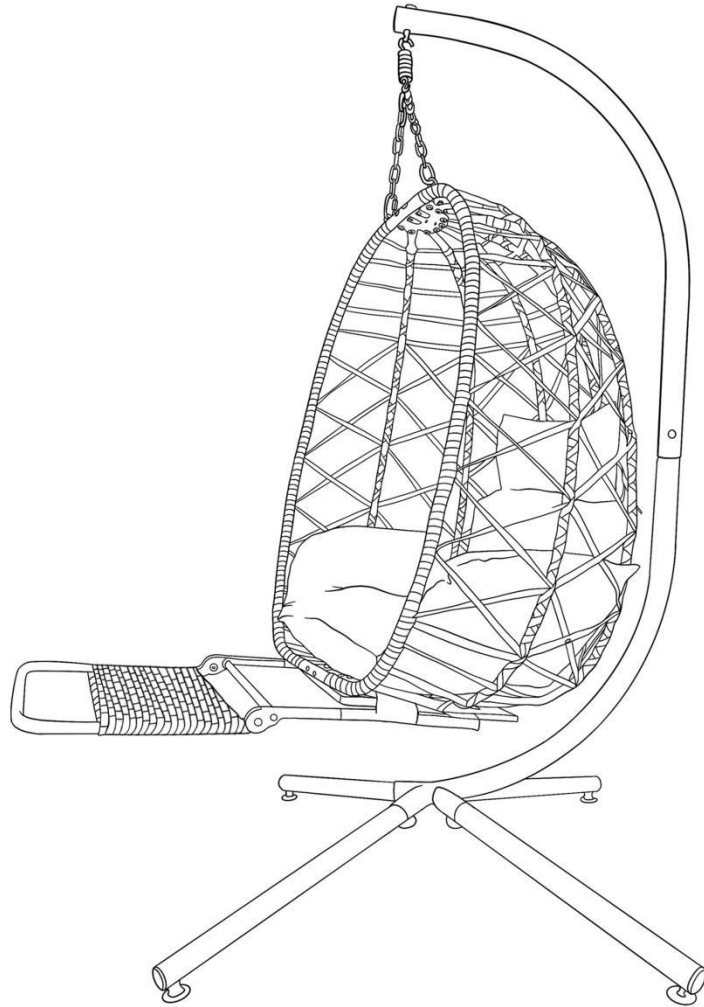

ONLINE SUPPORT

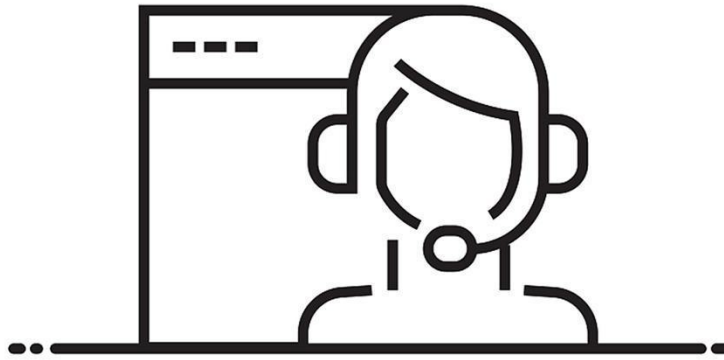

Please read the installation guide carefully before installation

If you have any questions during the installation process
you can contact us and we will provide you a detailed guidance