

1/14

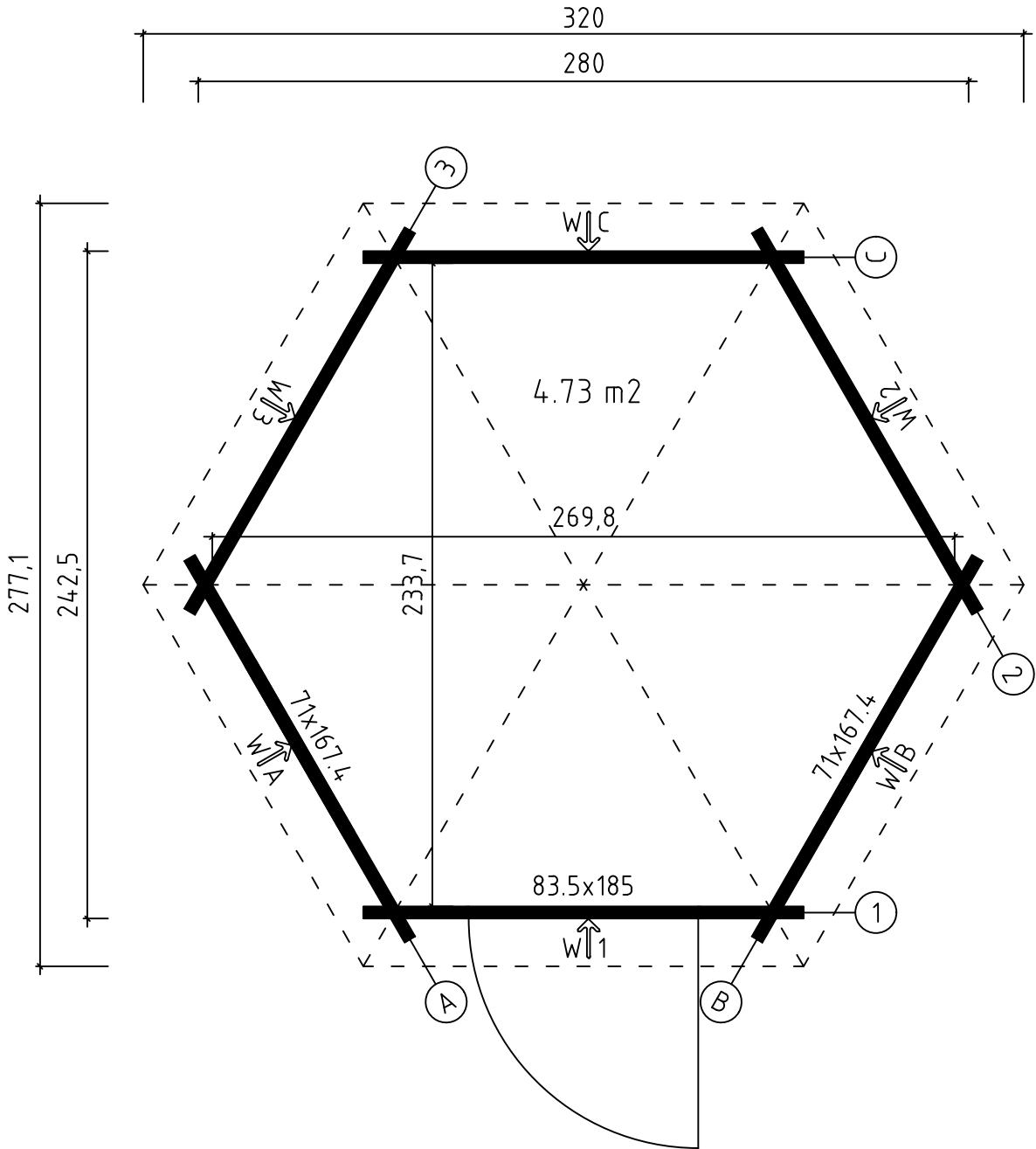

≈ 296 cm

Groundplan - Grundplan - Plan de masse - Planimetria -
Plattegrond - Põhiplaan



Foundation - Fundament - Fondation - Fondamenta -
Fundering - Immutatud alusraam

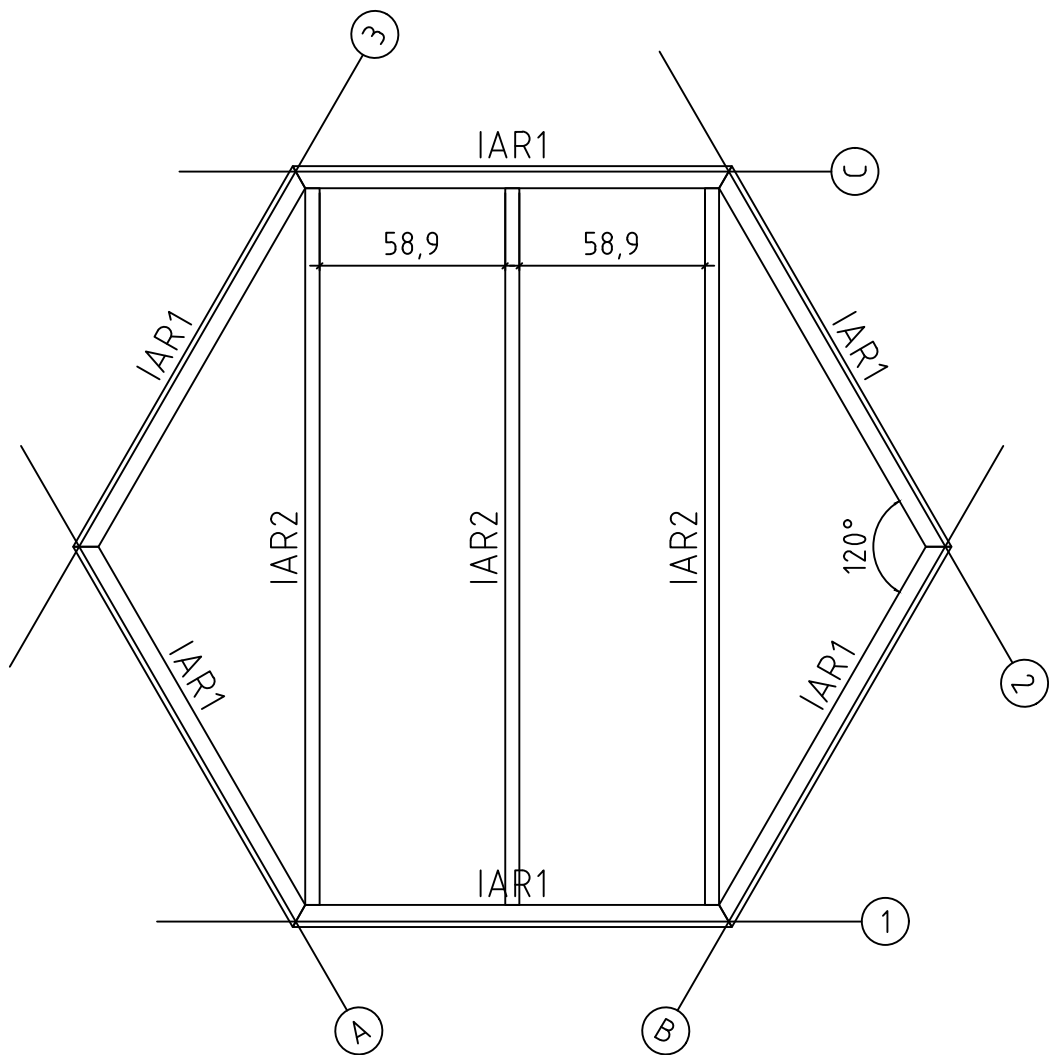

Floor boards - Fussbodenbretter - Plan pose plancher -
Pavimento - Vloerhout - Põrandalaudis

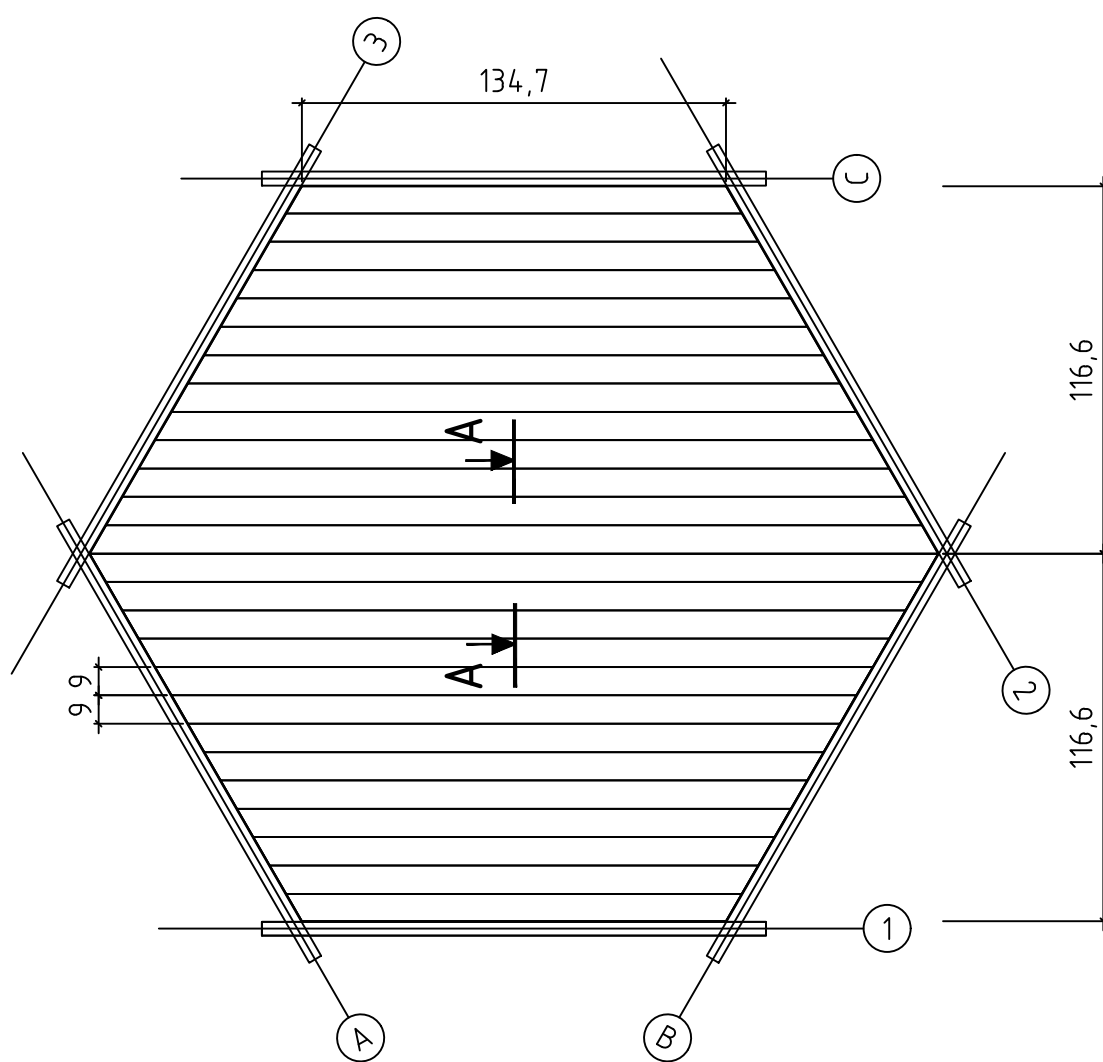

A - A

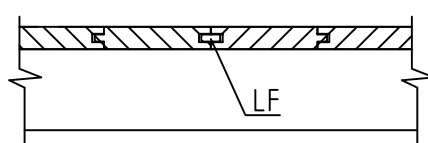

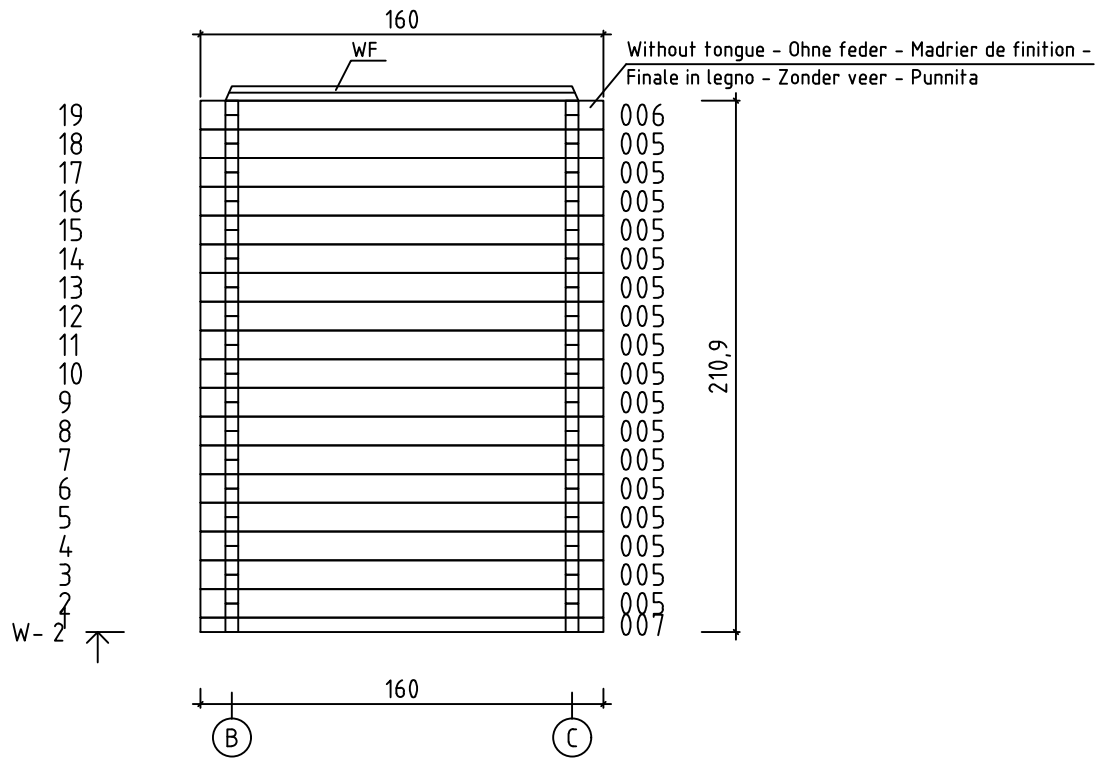
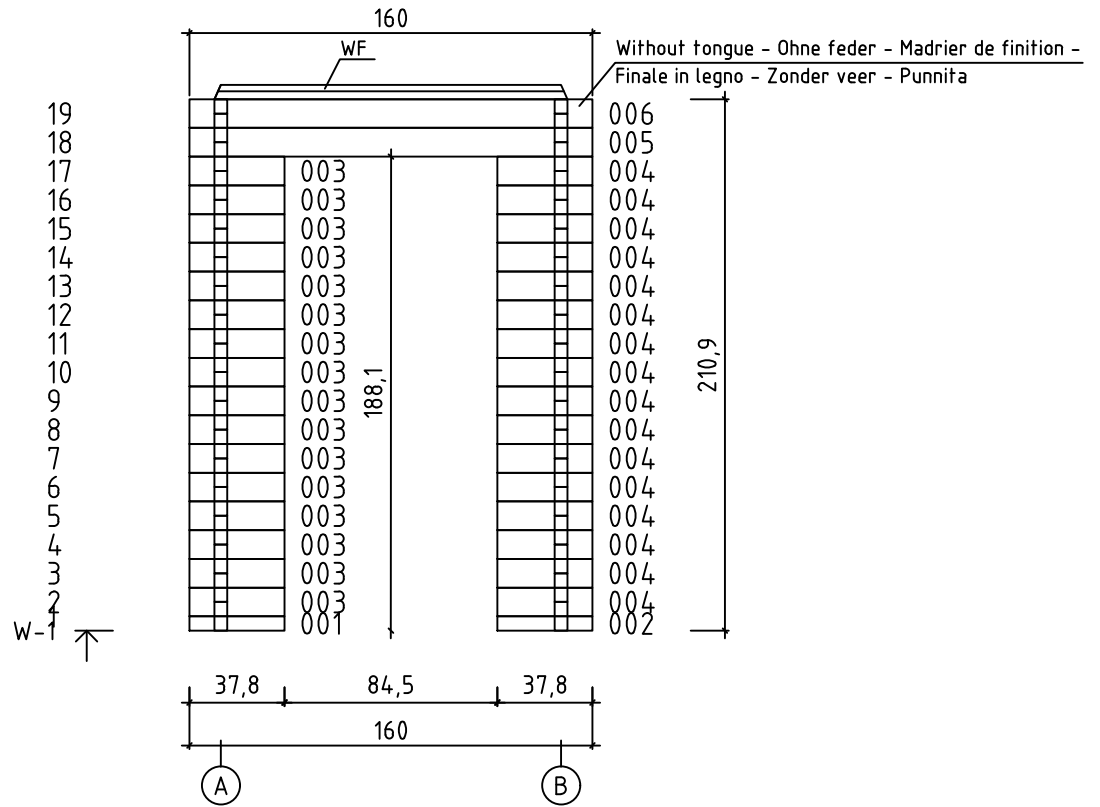

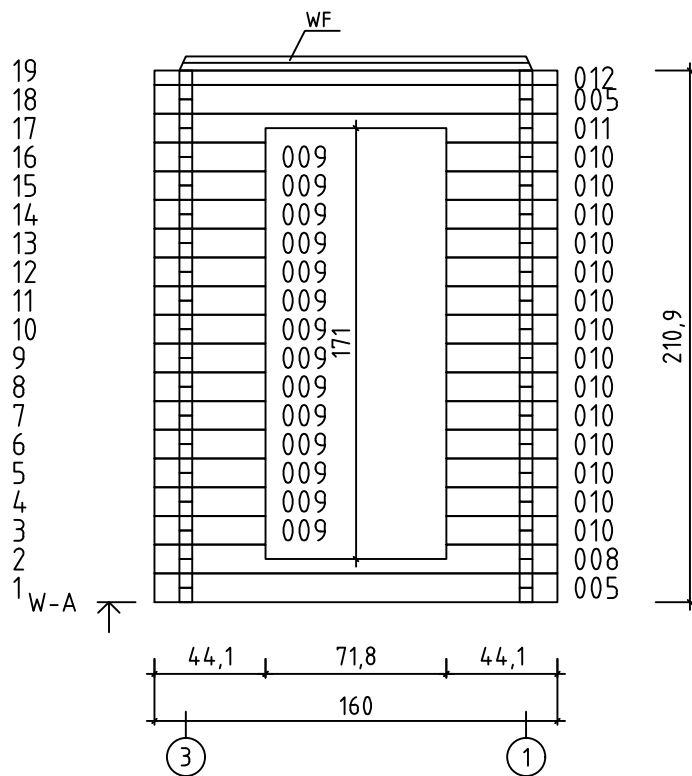
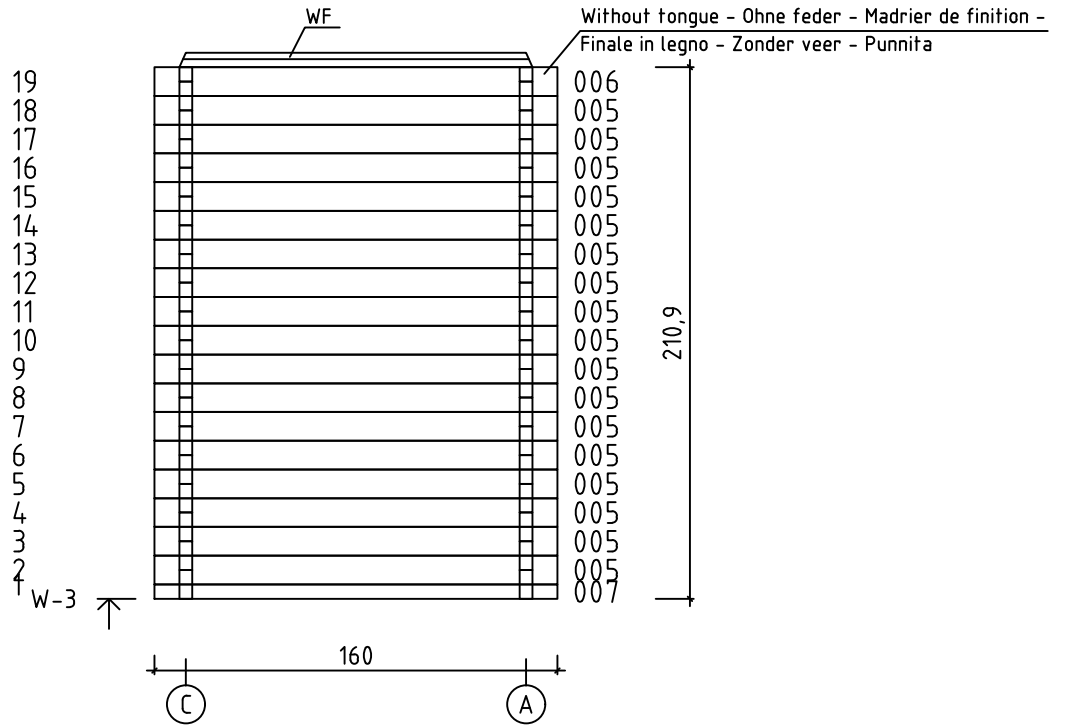

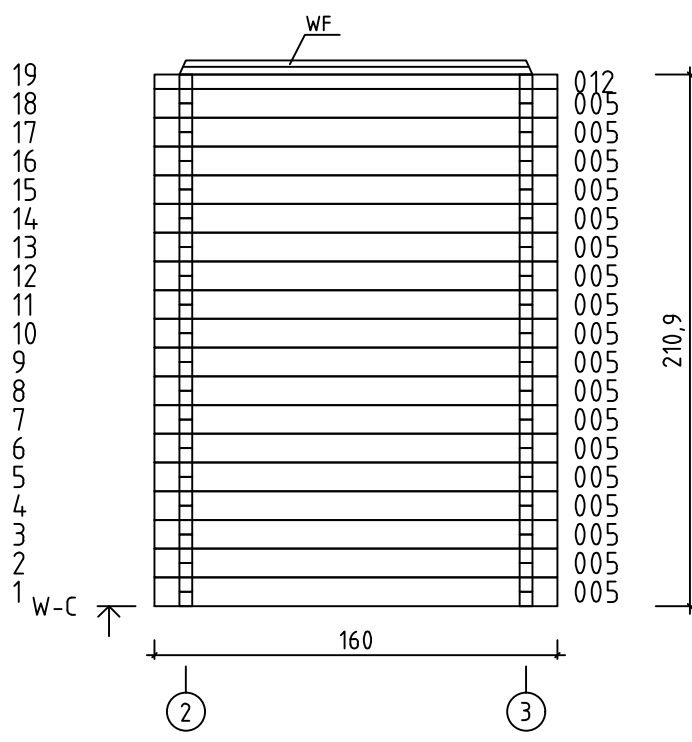
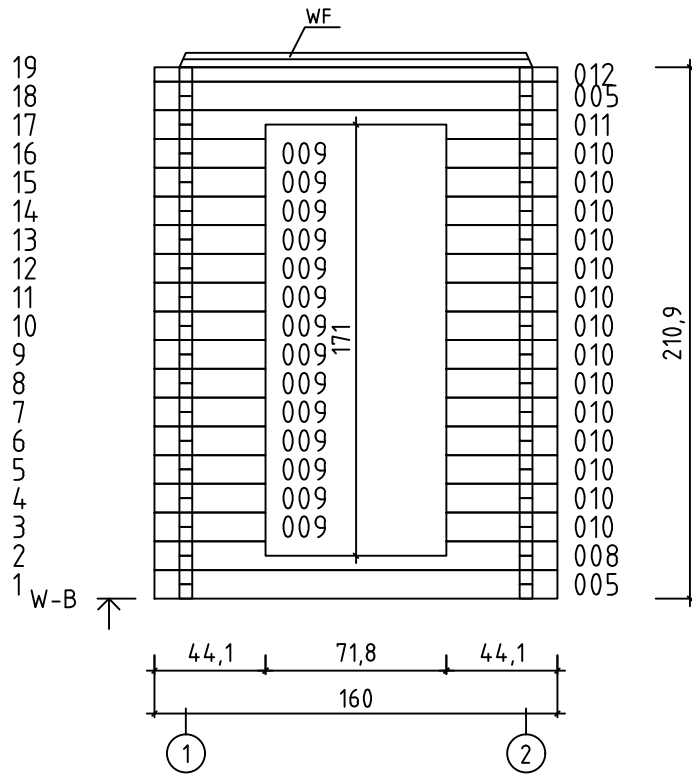

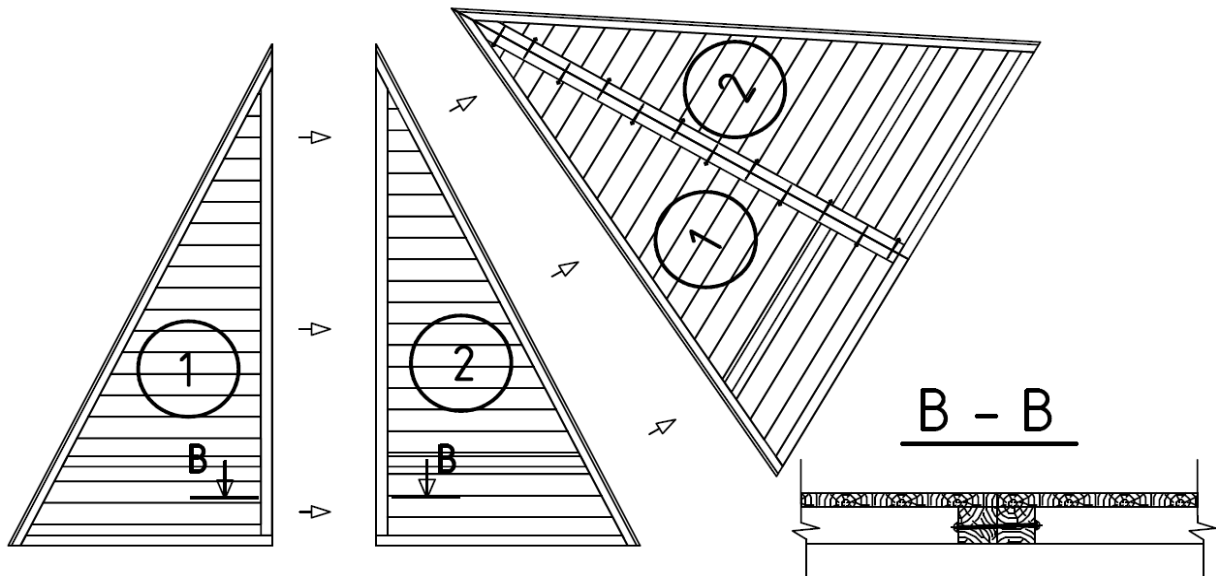

Attach left and right (1&2) roof panels together, using 2 screws HS1 (12 pcs total) at the lowest part (B-B). Then at regular intervals using the remaining 10 screws, attaching them on alternating sides.

Verbinden sie die linke und rechte (1&2) dachfläche mit den schrauben HS1 (12 stück insgesamt) beginnend an der tiefsten stelle (B-B). dann in regelmäßigen abständen die restlichen schrauben von beiden seiten bis hin zur spitze anbringen.

Assembler les panneaux de toit 1 et 2 avec les vis (HS1-12 vis au total) en les répartissant à intervalle régulier comme le montre le dessin ci-dessous.

Unire i pannelli del tetto 1 e 2 mediante le viti "HS1". Cominciate a fermare i pannelli con 2 viti e quindi finite di bloccarli con le restanti 10 ad intervalli regolari, come mostrato nella figura qui sotto (ne servono 12 in totale)

Voeg het linker-(1) en het rechterdakpaneel (2) samen. Gebruik 2 HS1 schroeven (12 stuk in totaal). Schroef deze 2 schroeven op de B-positie. Schroef vervolgens de overige 10 schroeven aan weerszijden vast.

Kinnitage vasak ja parem (1&2) katusekilp omavahel, alustades kilpide madalaimast osast (lõige B-B), kasutades kahte HS1 kruvi (kokku: 12tk.). Ülejäänud kümme kruvi kinnitage kindla sammuga vaheldumisi kilbi kummaltki poolelt.

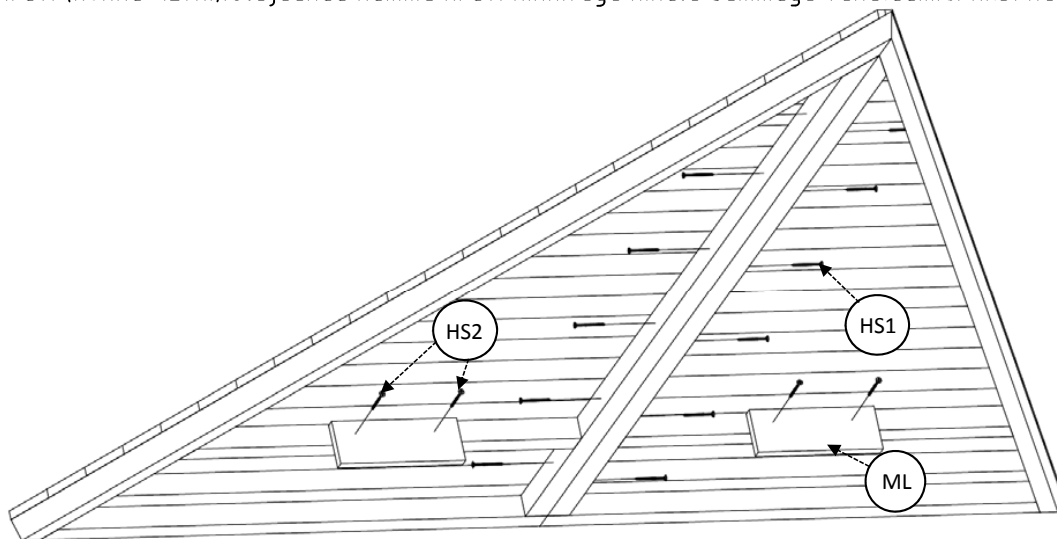

Using 2 screws (HS2) attach ML to the lower part cross batten on the underside of the roof panel (these are temporary supports).

Mit den zwei schrauben (HS2) befestigen sie die komponente ML auf dem unteren rahmenteil. Hierbei handelt es sich um stützen zur befestigung der dachflächen

Pour la mise en place des panneaux de toit, veuillez visser temporairement les détails ML aux traverses intermédiaires avec les 2 vis (HS2) pour chaque détail ML une fois la mise en place de la toiture terminée, vous pourrez les enlever.

Per posizionare i pannelli del tetto, fissate provvisoriamente gli elementi ML alle traverse intermedie usando n.2 HS2 viti cadauno. Terminato il montaggio del tetto potrete rimuovere gli elementi ML.

Gebruik 2 schroeven (HS2) en scoef deze op positie ML op het onderste gedeelte vast op de onderkant van het dakpaneel. Dit is ter tijdelijke ondersteuning.

Kinnitage detail ML katusekilbi raami külge, kasutades kahte HS2 kruvi (need on ajutised toed).

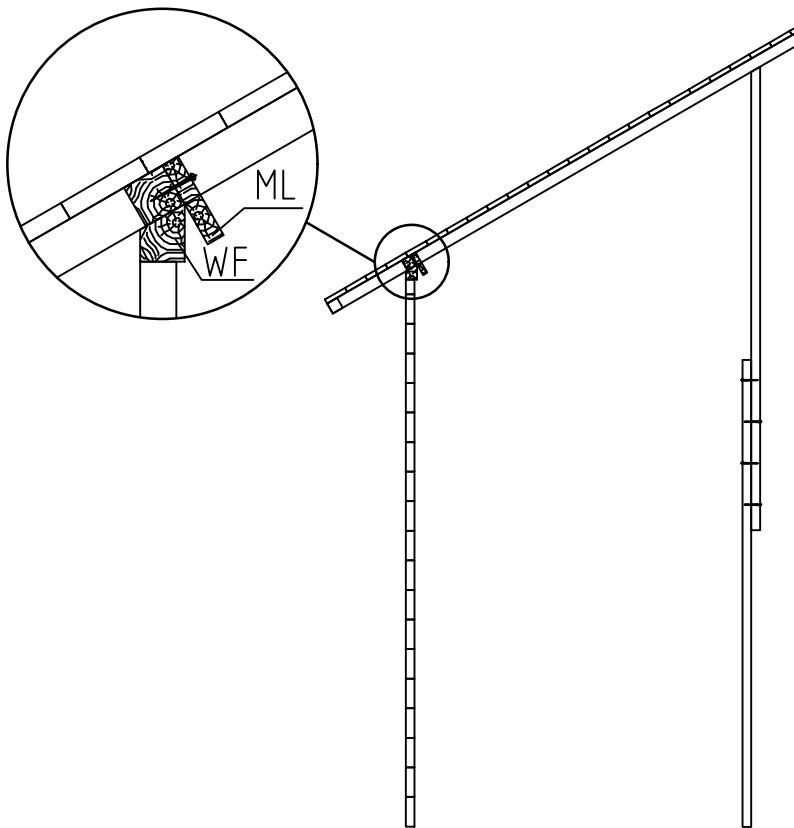

Attach together parts AB so that the entire length is 2990 mm using 4 screws provided HS3. This is a temporary support to help you mount the roof.

Verbinden sie die beiden komponenten AB mittels der vier schrauben HS3 miteinander. So dass die länge 2990 mm beträgt. Hierbei handelt es sich um eine temporäre stütze zur installation der dachflächen.

Pour la mise en place des panneaux de toit, veuillez visser avec 4 vis (HS3) les supports de maintien de toit AB ensemble de telle sorte a obtenir un poteau d'une hauteur totale de 2990 mm. Une fois la mise en place de la toiture terminée, vous pourrez l'enlever.

Voeg de onderdelen AB samen zodat de totale lengte 2990 mm is. Gebruik 4 schroeven (HS3). Dit is een tijdelijke bevestiging om je te helpen het dak te bevestigen.

Proseguite l'assemblaggio dei pannelli del tetto fissando con n 4 viti HS3 i supporti provvisori di sostegno del tetto AB in modo da ottenere un palo alto cm 299, che vi aiuterà nel posizionamento degli stessi pannelli, dopo di che potrete smontarlo.

Kasutades nel ja HS3 kruvi,kinnitage detailid AB nii, et kogupikkus on 2990 mm. See on ajutine tugi katusekilpide paigaldamiseks.

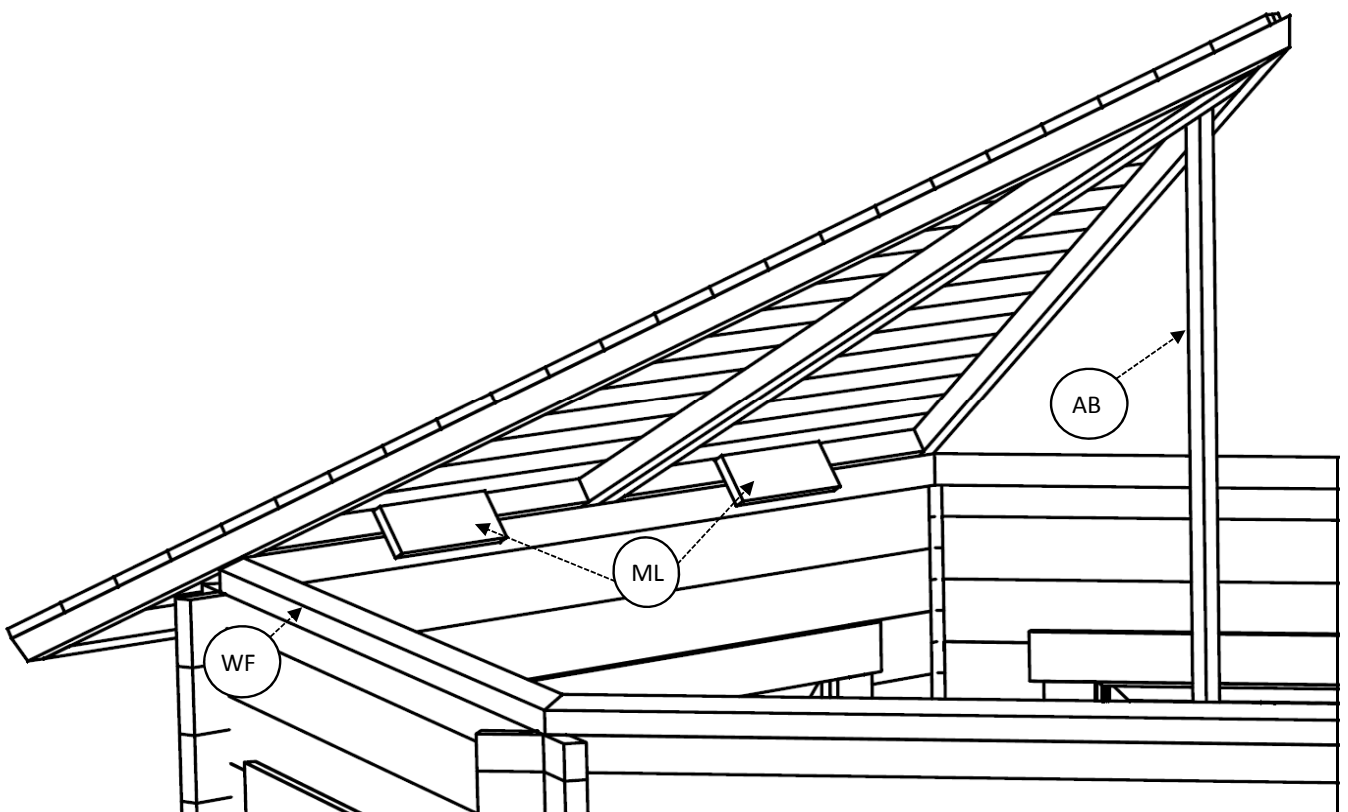

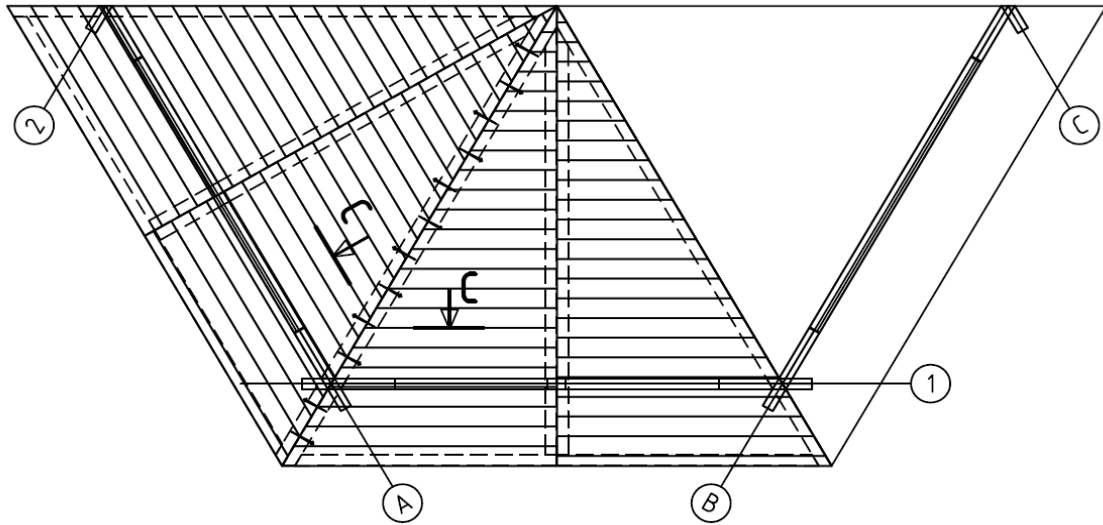

Mount the first roof section you have created next to the second one (C-C), (with the help of roof support AB)-making sure they are aligned and using screws HS1 (12pcs) screw alternate sides all the way up, (do not tighten until all panels have been attached, you may need to adjust the positioning and height at the end). Once the correct positioning has been achieved tighten all screws.

Montieren sie nun nacheinander die einzelnen dachflächendreiecke unter zuhelfenahme der stütze AB. Verbinden sie die einzelnen dreiecke wieder mit den schrauben HS1 (12 st.) vom boden bis zur spitze. die schrauben bitte nicht sofort fest anziehen, so dass sie die dachelemente ggf. noch justiert werden können. nachdem alle deiecke an seiner korrekten position sind und das dach justiert wurde, bitte die schrauben fest anziehen.

Placer sur le toit les éléments de toit préassemblés côte à côte (C-C), en vous aidant du poteau de maintien de toit AB. Assurez-vous de leur bon alignement et visser les ensemble à intervalle régulier en utilisant les vis HS1(12 vis pour fixer à chaque fois 2 panneaux). Attention, ne pas visser à fond tant que tous les panneaux ne sont pas mis en place, car vous aurez peut-être besoin d'ajuster le positionnement de certains d'entre eux. Une fois tous les panneaux de toit mis en place correctement, alors visser à fond.

Posizionate sul tetto le coppie di pannelli precedentemente avvitate (C-C) aiutandovi con il palo precedentemente assemblato AB. Assicuratevi che siano ben allineate, quindi fissateli senza avvitare a fondo le viti. Utilizzate n. 12 viti HS1 ad intervalli regolari per ogni lato da unire. Controllate che le coppie dei pannelli siano posizionate perfettamente tra loro, quindi avvitate a fondo le viti!

Bevestig de eerste dak sectie die je gemaakt hebt naast de 2e (C-C) met behulp van de dak ondersteuning (AB). Zorg dat de onderdelen evenredig verdeeld zijn en maak gebruik van de HS1 schroeven (12 stuks). Schroef de dak sectie afwisselend aan beide kanten naar boven toe vast. Doe dit niet te strak totdat alle secties bevestigd zijn. Aan het eind kun ja dan nog de positie en de hoogte aanpassen. Als dit gedaan is wel de schroeven wel stevig aan draaien.

Tõstke üks monteeritud katusekilp teise kõrvale (C-C), (montaažilati AB abiga)-veenduge et katusekilbid oleks kohakuti ja seejärel kasutades kruvi HS1 (12tk.) kinnitage kindla sammuga vaheldumisi kilbi kummaltki poolelt.



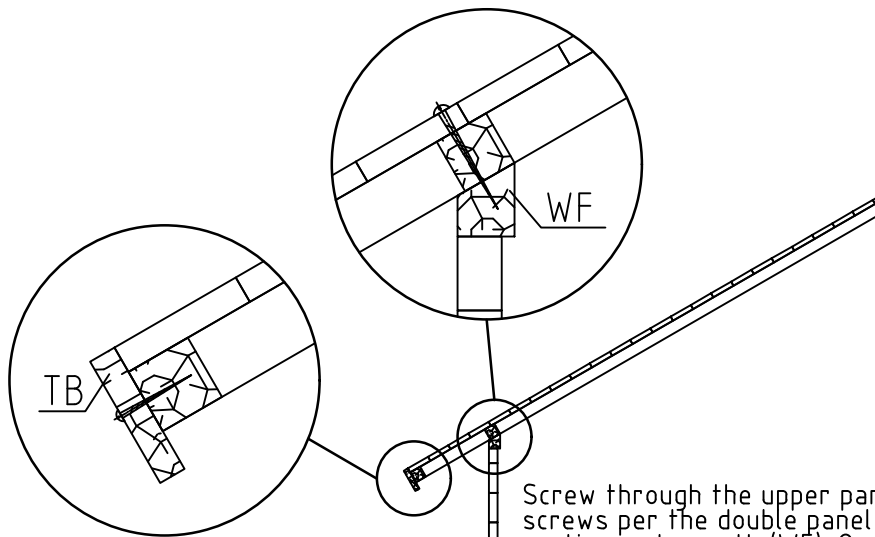

Under the eaves of the roof edge attach the fascia board TB using screws provided HS5 (3pcs).

Anschließend bringen sie bitte die umlaufenden abschlußbretter (TB) mittels der drei schrauben HS5 jeweils am unteren rahmenteil der dachflächendreiecke an.

Fixer les planches de rives TB aux extrémités visibles des panneaux de toit avec les vis HS5 (3 vis par planche).

Fissate il massello di rifinitura TB in testa davanti l'estremità visibile dei pannelli del tetto usando le viti HS5 nella quantità di n. 3 viti ogni lato.

Bevestig de gevellijst TB onder de dakrand met behulp van de HS5 schroeven(3 stuks).

Katusekilbi otsa kinnitage räästalaud TB, kasutades kruvi HS5 (3tk.)

Screw through the upper part of the roofing using HS4 screws (8 screws per the double panel section you created) into the wall section underneath (WF). Once this is complete you can then remove the temporary supports AB and ML.

Schrauben sie nun durch die dachelemente (B-B,C-C etc.) die schrauben HS4 (8 schrauben je doppel-dreieck) in die darunter liegende komponente WF um die dachflächen mit den wänden zu verbinden. Sobald dies abgeschlossen ist, können die temporären stützen ML und AB entfernt werden.

Visser les panneaux de toit en place aux madriers supérieurs de finition (WF) en utilisant les vis HS4 (8 vis par panneaux préassemblés). Une fois terminée, vous pouvez enlever les supports ML de chaque panneau et le poteau de maintien de toit AB.

Avvitare il tetto da sopra utilizzando n. 8 viti HS4 in ogni lato dell'esagono ottenuto, alla sommità delle pareti del gazebo. Terminata questa operazione potrete tranquillamente togliere gli elementi ML ed il palo di sostegno AB essendo divenuti ormai inutili.

Schroef door het bovenste gedeelte van het dak met de HS4 schroeven (8 schroeven per dubbele paneel sectie). Wanneer dit gedaan is kan de tijdelijke ondersteuning ML en AB verwijderd worden.

Kinnitage katusekilp pealt poolt seina külge (WF), kasutades kruvi HS4 (8 kruvi ühele monteeritud katusekilbile). Seejärel saate eemaldada ajutised toed AB, ML.

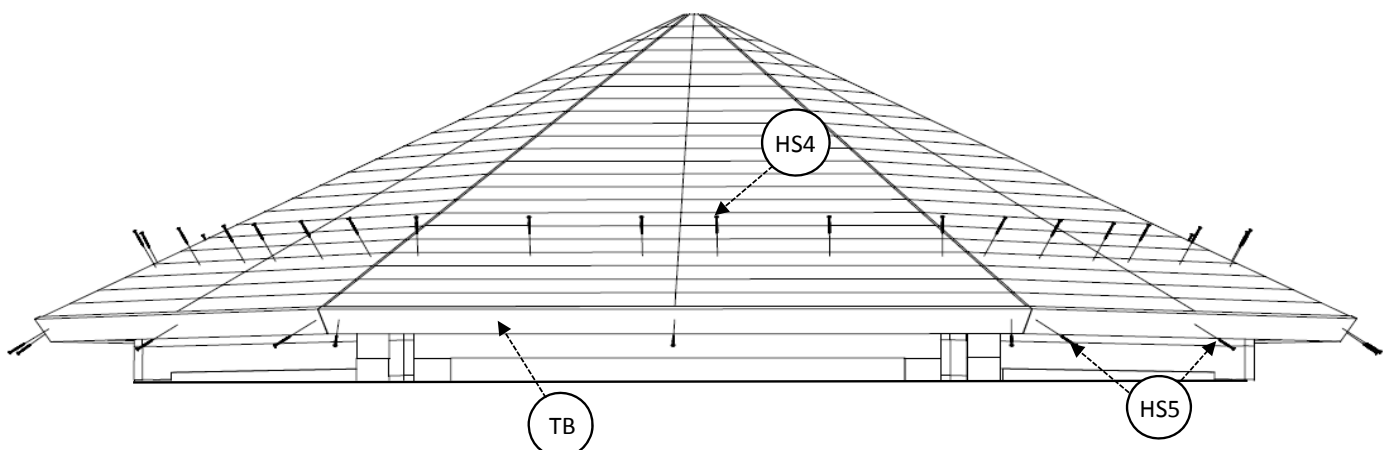

Then you are ready to apply shingles or felt(not supplied).













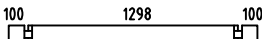
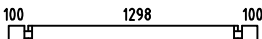
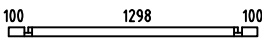
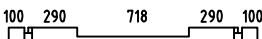

Nun können sie damit beginnen die dacheindeckung zu verlegen(nicht im lieferumfang enthalten).

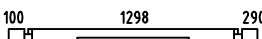
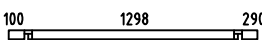

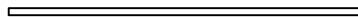



Vous pouvez maintenant procéder à la mise en place de la finition de toiture (fournie séparément en option).

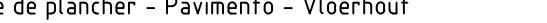
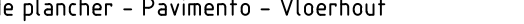
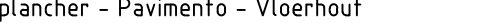



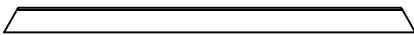
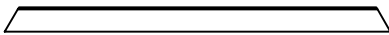
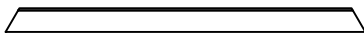
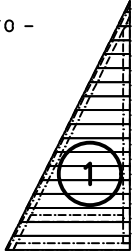
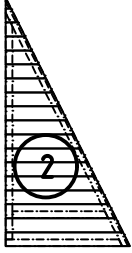

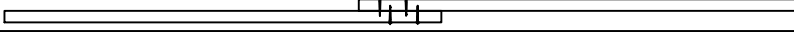
Adesso potete applicare sul tetto qualsiasi tipo di protezione e rifinitura abbiate deciso di acquistare.

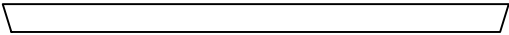
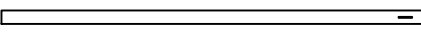
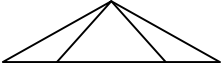
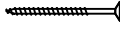
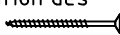
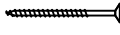
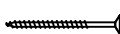
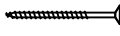
Hierna kan het asfaltpapier of de shingels gemonteerd worden.



Nüüd on katus valmis katusekatte materjaliks (ei sisaldu maja tarnekomplektis).

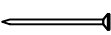
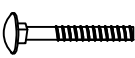



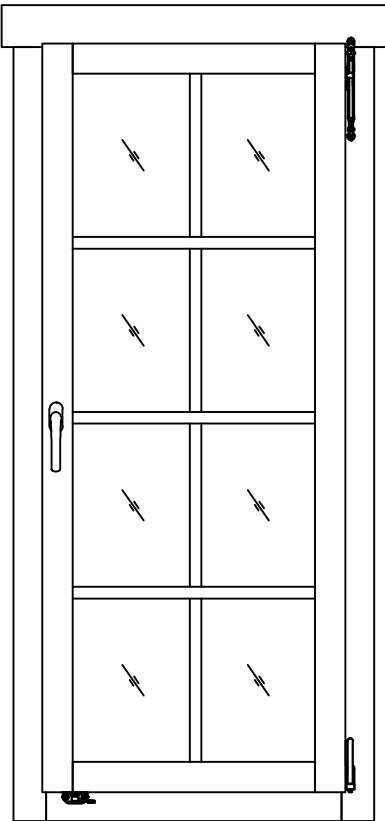
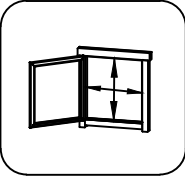
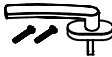
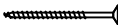

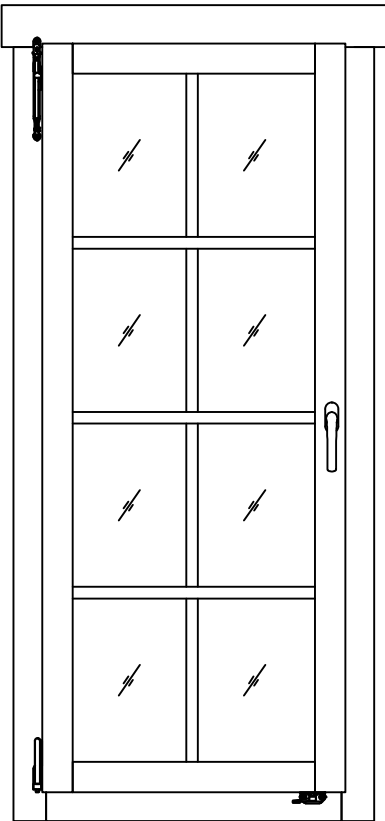
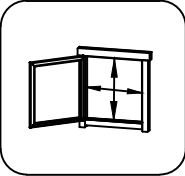

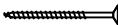
Pos	Piece list - Stückliste - Liste des pièces - Elementi - Stuklijst - Tükitalabel 12/14	Q	P (mm)	L (mm)
001		1	44x57	378
002		1	44x57	378
003		16	44x114	378
004		16	44x114	378
005		57	44x114	1600
006	 Without tongue - Ohne feder - Madrier de finition - Finale in legno - Zonder veer - Punnifa	3	44x114	1600
007		2	44x57	1600
008		2	44x114	1600
009		28	44x114	441
010		28	44x114	441
011		2	44x114	1600
012		3	44x57	1600
IAR1	Foundation - Fundament - Fondation - Fondamenta - Fundering - Immutatud alusraam 	6	70x45	1394
IAR2	Foundation - Fundament - Fondation - Fondamenta - Fundering - Immutatud alusraam 	3	45x45	2275
WF	Lath - Pfetten - Liteau - Piccola asse - Gordingen - Roov 	6	44x57	1400
	Floor boards - Fussbodenbretter - Lamé de plancher - Pavimento - Vloerhout - Põrandalaud 	2	90x18	2694
	Floor boards - Fussbodenbretter - Lamé de plancher - Pavimento - Vloerhout - Põrandalaud 	2	90x18	2590
	Floor boards - Fussbodenbretter - Lamé de plancher - Pavimento - Vloerhout - Põrandalaud 	2	90x18	2486
	Floor boards - Fussbodenbretter - Lamé de plancher - Pavimento - Vloerhout - Põrandalaud 	2	90x18	2382
	Floor boards - Fussbodenbretter - Lamé de plancher - Pavimento - Vloerhout - Põrandalaud 	2	90x18	2278
	Floor boards - Fussbodenbretter - Lamé de plancher - Pavimento - Vloerhout - Põrandalaud 	2	90x18	2174
	Floor boards - Fussbodenbretter - Lamé de plancher - Pavimento - Vloerhout - Põrandalaud 	2	90x18	2070
	Floor boards - Fussbodenbretter - Lamé de plancher - Pavimento - Vloerhout - Põrandalaud 	2	90x18	1966

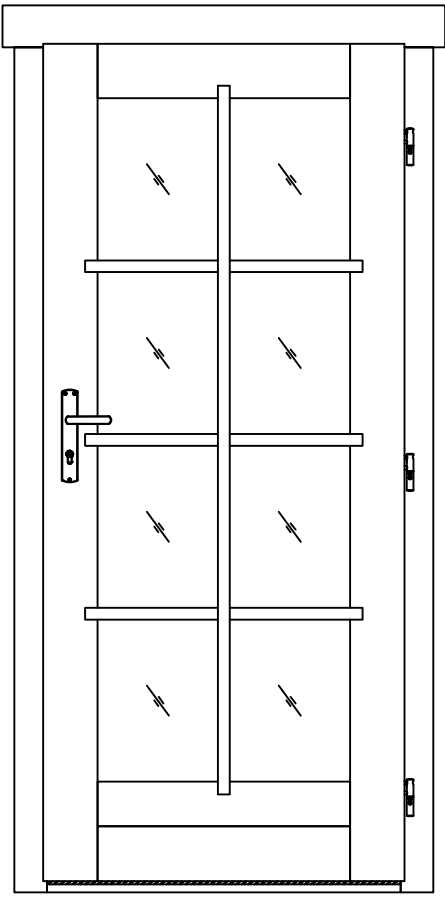
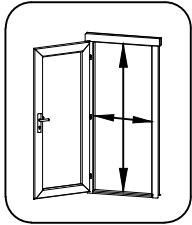
Pos	Piece list - Stückliste - Liste des pièces - Elementi - Stuklijst - Tükitalabel 13/14	Q	P (mm)	L (mm)
	Floor boards - Fussbodenbretter - Lame de plancher - Pavimento - Vloerhout - Põrandalaud 	2	90x18	1862
	Floor boards - Fussbodenbretter - Lame de plancher - Pavimento - Vloerhout - Põrandalaud 	2	90x18	1758
	Floor boards - Fussbodenbretter - Lame de plancher - Pavimento - Vloerhout - Põrandalaud 	2	90x18	1655
	Floor boards - Fussbodenbretter - Lame de plancher - Pavimento - Vloerhout - Põrandalaud 	2	90x18	1551
	Floor boards - Fussbodenbretter - Lame de plancher - Pavimento - Vloerhout - Põrandalaud 	2	90x18	1447
1	Roof element - Dachelement - Panneau de toit prémonté - Componente del tetto - Dakelement - Katusekilp 	6	62x800x1600	
2	Roof element - Dachelement - Panneau de toit prémonté - Componente del tetto - Dakelement - Katusekilp 	6	62x800x1600	
	Floor fillet - Fussbodenleiste - Corniere de finition du plancher - Finitura per pavimento (battisco pa) - Vloerafwerkljst - Põrandaliist 		18x18	6.73
AB	Assembly batten - Montagelatte - Baguettes de maintien, nécessaires a la mise en place des panneaux de toit - Battente di montaggio - Montage lat - Montaažilatt 	2	28x34	1800
LF	Fitting slat - Lose feder - Profil de jonction - Stecca di raccordo - Losse veer - Põranda ühendusliist (vineerist) 	1	6x15	2685
ML	Assembly batten - Montagelatte - Baguettes de maintien, nécessaires a la mise en place des panneaux de toit - Battente di montaggio - Montage lat - Montaažilaud katusekilpide fikseerimiseks 	12	18x90	
TB	Fascia board - Traufbrett - Bandeau de toit - Finitura lati tetto - Gevelljst - Räästalaud 	6	18x90	1628
KFS-1	Storm protection - Sturmleiste - Latte anti-tempete - Protezione anti vento - Stormverankering / beveiligung - Tormikinnitusliist 	6	22x45	2050
	Roof cap - Dachkappe - Chapeau de toit - Punta del tetto - Dak afdekkap - Katusetipu müts 	1		
HS1	Screw for fixing roof elements - Schraube für befestigung - dachelementen - Vis de fixation des panneaux de toit - Vite per fissare gli elementi del tetto - Schroef voor bevestiging dakelement - Kruvi kilpide montaažiks 	144	4.5x80	
HS2	Screw for assembly batten (ML) - Schrauben für montagelatte (ML) - Vis de fixation des baguettes de maintien pour mise en place du toit (ML) - Viti per assemblaggio stecca (ML) - Schroef voor montage lat (ML) - Kruvi katusekilpide fikseerimiseks 	24	4x40	
HS5	Screw for fascia boards - Schrauben für traufbretter - Vis pour fixation bandeau de toit - Viti x striscia del tetto - Schroef voor gevellijst - Kruvi räästalauale 	18	4x40	
HS3	Screw for assembly batten - Schrauben für montagelatte - Vis de fixation des baguettes de maintien pour mise en place du toit - Viti per assemblaggio stecca - Schroef voor montage lat - Kruvi montaažilatile 	4	4x60	
HS16	Screw for 1. wall beam - Schraube für 1. bohlenreihe - Vis de fixations 1ere rangée de madriers avec poutrelles de fondations - Vite fissaggio alle fondamenta - Schroef voor 1 wandbalk - Kruvi poollauale 	8	5x90	

Pos	Piece list - Stückliste - Liste des pièces - Elementi - Stuklijst - Tükítabel 14/14	Q	P (mm)	L (mm)
HS16	Screw for foundation - Schrauben zur befestigung fundament - Vis de fixations des poutrelles de fondations - Viti x fundamenta - Schroef voor fundering - Kruvi alusraamile 	18	5x90	
HS4	Screw for fixing roof elements - Schraube für befestigung dachelementen - Vis de fixation des panneaux de toit - Vite per fissare gli elementi del tetto - Schroef voor bevestiging dakelement - Kruvi kilpide kinnitamiseks seinaga 	48	5x90	
HS16	Screw for roof lath - Schraube für dachlatte - Vis pour latte - Vite per listello del tetto - Schroef voor daklat - Kruvi roovile 	18	5x90	
SH44	Hammer block - Schlagholz - Calle de frappe - Blocco di legno da usare come cuscinetto quando si usa il martello - Slagklos - Löögiklots 	1		
SFS	Nut for storm protection - Schraubenmutter für sturmleiste - Ecrou pour latte anti-tempete - Dado x asta protezione vento - Moer voor stromverankering - Mutter tormikinnitusliistule 	12	D8	
NF4	Zn nail for floor - Zn nägel für fussbodenbretter - Clous pour plancher - Chiodi x perline pavimento - Spijker(nagel) voor vloer - Nael põrandalauale 	132	2x50	
BFS	Bolt for storm protection - Bolzen für sturmleiste - Boulon pour latte anti-tempete - Bullone x asta protezione vento - Bout voor stormankerlat - Puidupolt tormikinnitusliistule 	12	8x80	
DFS	Washer for storm protection - Dichtscheibe für sturmleiste - Rondelle pour latte anti-tempete - Rondella x asta protezione vento - Afdichtring voor storm strip - Seib tormikinnitusliistule 	12	D8	
	Window - Fenster - Fenetre - Finestra - Raam - Aken 710x1674 AK.1.108.TPSP.e DGP+	1		
	Window - Fenster - Fenetre - Finestra - Raam - Aken 710x1674 AK.1.108.TPSV.e DGP+	1		
	Door - Tür - Porte - Porte - Deur - Uks 835x1850 UK.1.108.TPVP.MMa DGP+	1		

Pos	Piece list - Stückliste - Liste des pièces - Elementi - Stuklijst - Tükitalabel 710x1674 AK.1.108.TPSP.e DGP+	1/1	Q	P (mm)	L (mm)
	<p data-bbox="256 152 1289 181">Glass size - Glasgröße - Taille de la vitre - Misura del vetro - Glas afmeting - Klaasi mõõt: 540x1496 mm</p>   <p data-bbox="1369 349 1490 378">610x1578 mm</p>				
FS2	<p data-bbox="256 2040 1023 2096">Window handle fittings - Fenstergriff - Poignée de fenetre - Maniglia c/ferramenta - Raamhendel -/grendel -/klink - Aknalink</p>		1		
HS1	<p data-bbox="256 2119 1107 2197">Screw for georgian bars - Schraube für sprossen - Vis pour croisillons - Viti per unire la griglia georgiana della finestra - Schroeven voor raamverdeling - Kruvi akna petfeliistule</p>		8	2.5x20	

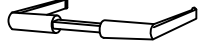
Pos	Piece list - Stückliste - Liste des pièces - Elementi - Stuklijst - Tükítabel 710x1674 AK.1.108.TPSV.e DGP+	1/1	Q	P (mm)	L (mm)
	<p data-bbox="256 152 1289 181">Glass size - Glasgröße - Taille de la vitre - Misura del vetro - Glas afmeting - Klaasi mõõt: 540x1496 mm</p>   <p data-bbox="1369 349 1490 378">610x1578 mm</p>				
FS2	Window handle fittings - Fenstergriff - Poignee de fenetre - Maniglia c/ferramenta - Raamhendel -/grendel -/klink - Aknalink		1		
HS1	Screw for georgian bars - Schraube für sprossen - Vis pour croisillons - Viti per unire la griglia georgiana della finestra - Schroeven voor raamverdeling - Kruvi akna petfeliistule		8	2.5x20	

Pos	Piece list - Stückliste - Liste des pièces - Elementi - Stuklijst - Tükítabel 835x1850 UK.1.108.TPVP.MMa DGP+	1/1	Q	P (mm)	L (mm)
Glass size - Glasgröße - Taille de la vitre - Misura del vetro - Glas afmeting - Klaasi mõõt: 561x1486 mm 				 735x1766 mm	
HS1	Screw for georgian bars - Schraube für sprossen - Vis pour croisillons - Viti per unire la griglia georgiana della finestra - Schroeven voor raamverdeling - Kruvi ukse petteliistule		8	2.5x20	
HS16	Screw for door jamb - Schraube für Türrahmen - Vis de fixation partie haute avec montants du cadre de porte - Viti x fissaggio montanti porte - Schroef voor deurkozijn - Kruvi ukse lengile		4	5x90	
HS25	Screw for doorstep - Schrauben für swelle - Vis pour fixation barre de seuil - Vite per soglia della porta - Schroef voor deurdorpel - Kruvi lävepakule		2	4.5x65	
MH	Male bolt hinge for door - Türband - Partie male de paumelle de porte - Cerniera anube x porta - Scharnier bout - Reguleeritav polthing isane		3	14x80	
HC	Covers for door hinges - Schutzkappe für Türband - Couverture de paumelle de porte - Copertura delle cerniere della porta - Afdek kap voor deurscharnier - Reguleeritava polthinge kate		6		
TL4	Door handle fittings - Türgriff - Poignée de porte - Maniglie - Deurhendel / klink - Ukse käepide		1		
TL5	Set of door lock covers - Schlossblenden - Set de garnitures de porte - Copertura serrature - Slot sluitplaat set - Ukse lukuplaat		1		
	Cylinder lock - Zylinderschloss - Barillet de porte - Serratura - Cylinder slot - Ukse lukusüdamik		1	30x35	