

ASSEMBLY INSTRUCTIONS

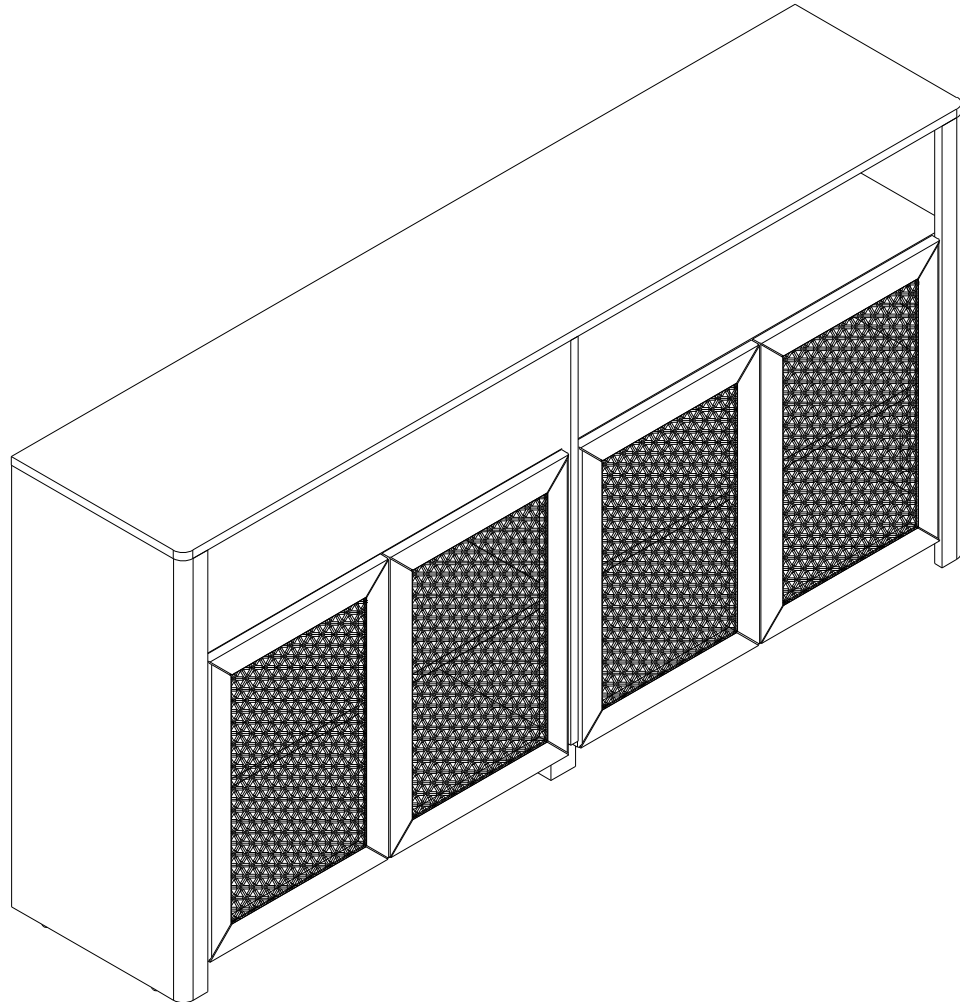

Notice:

1. Follow the installation instructions. Please confirm all accessories are preset before installation.
2. Do not fully tighten the screws during initial assembly. Fully tighten screws only once all pieces which are correctly assembled.
3. If you encounter any problems during installation, please contact our customer service.
4. Please unbox the item from the side with an open-label and put a carpet on the floor to avoid scratching it.

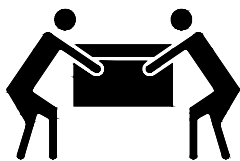

Recommended installers:2

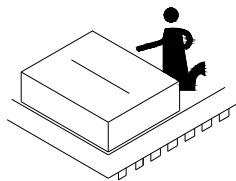

Put a carpet on the floor
before unpacking

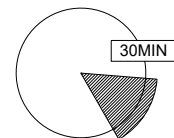

Estimate installation time:
30minutes





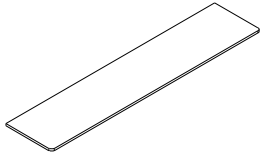
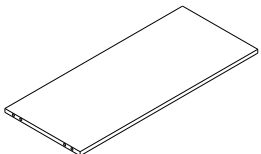
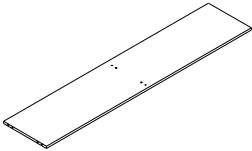
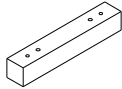
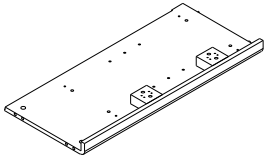
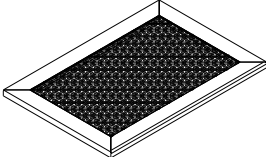
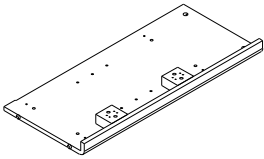
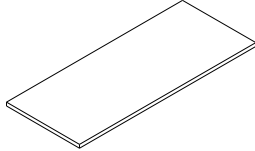
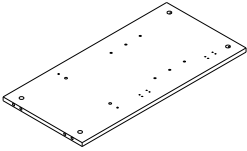
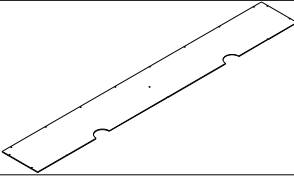
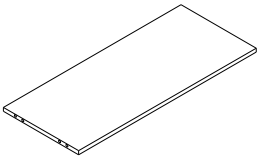
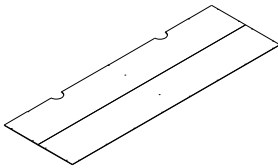

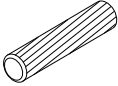

ASSEMBLY INSTRUCTIONS

PART LIST

Item no.	Reference Image	Qty	Item no.	Reference Image	Qty
(A)		X1	(G)		X1
(B)		X1	(H)		X1
(C)		X1	(I)		X4
(D)		X1	(J)		X2
(E)		X1	(K)		X1
(F)		X1	(L)		X1

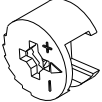
ASSEMBLY INSTRUCTIONS

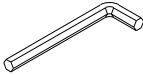
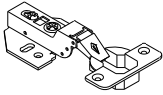
HARDWARE LIST

Item no.	Reference Image	Qty	Item no.	Reference Image	Qty
1	 Ø8*30mm	X22+2	7		X4
2		X20+2	8	 Ø3*15mm	X32+3
3		X20+2	9		X8
4	 Ø1/4"*2"	X2	10		X1
5		X8	11		X2
6	 Ø3*12mm	X48+4			

ASSEMBLY INSTRUCTIONS

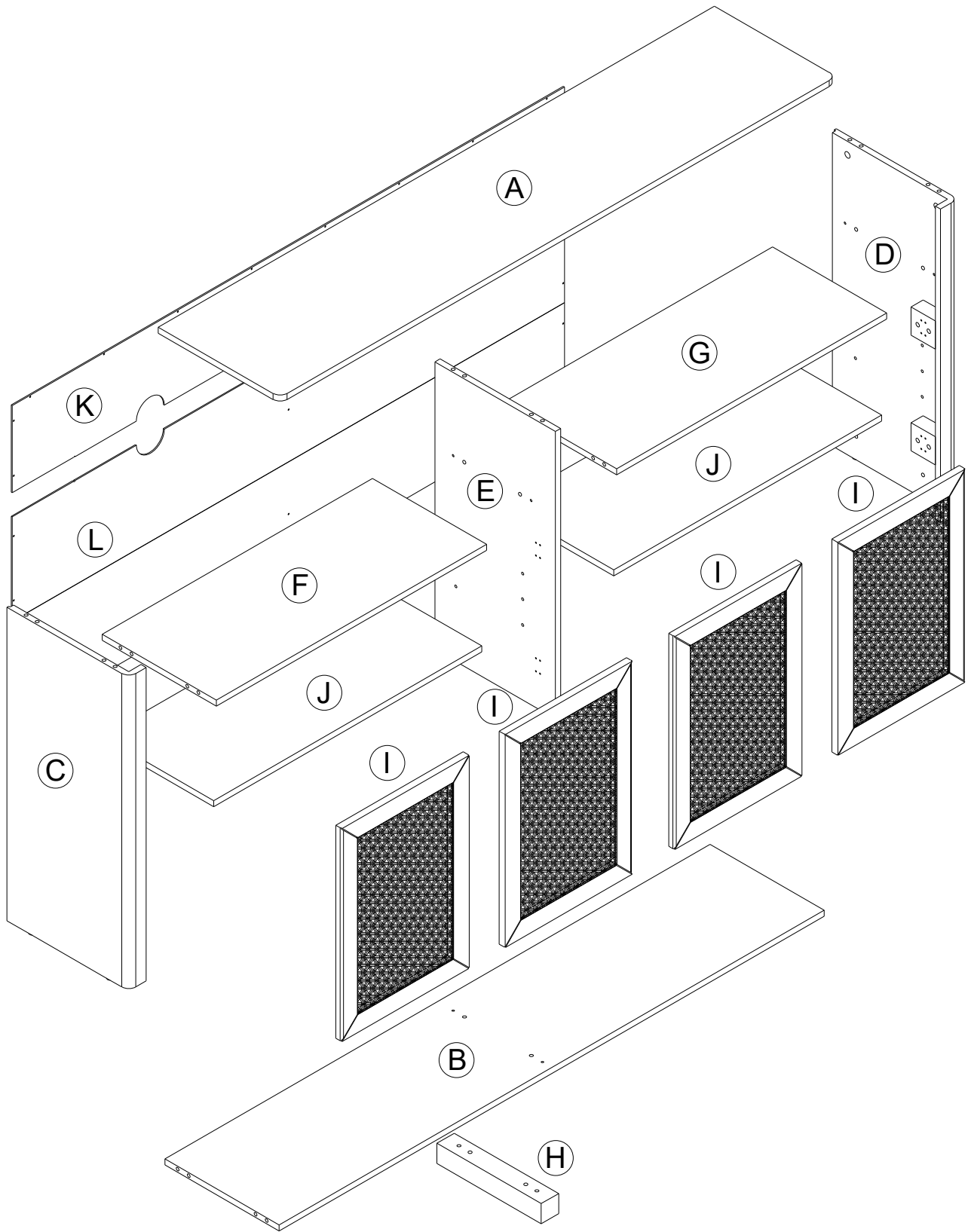

ASSEMBLY INSTRUCTIONS

1

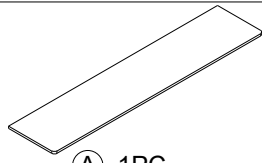

(A) 1PC

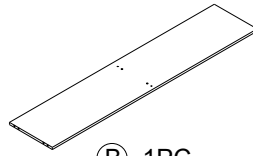

(B) 1PC



(2) 8PCS

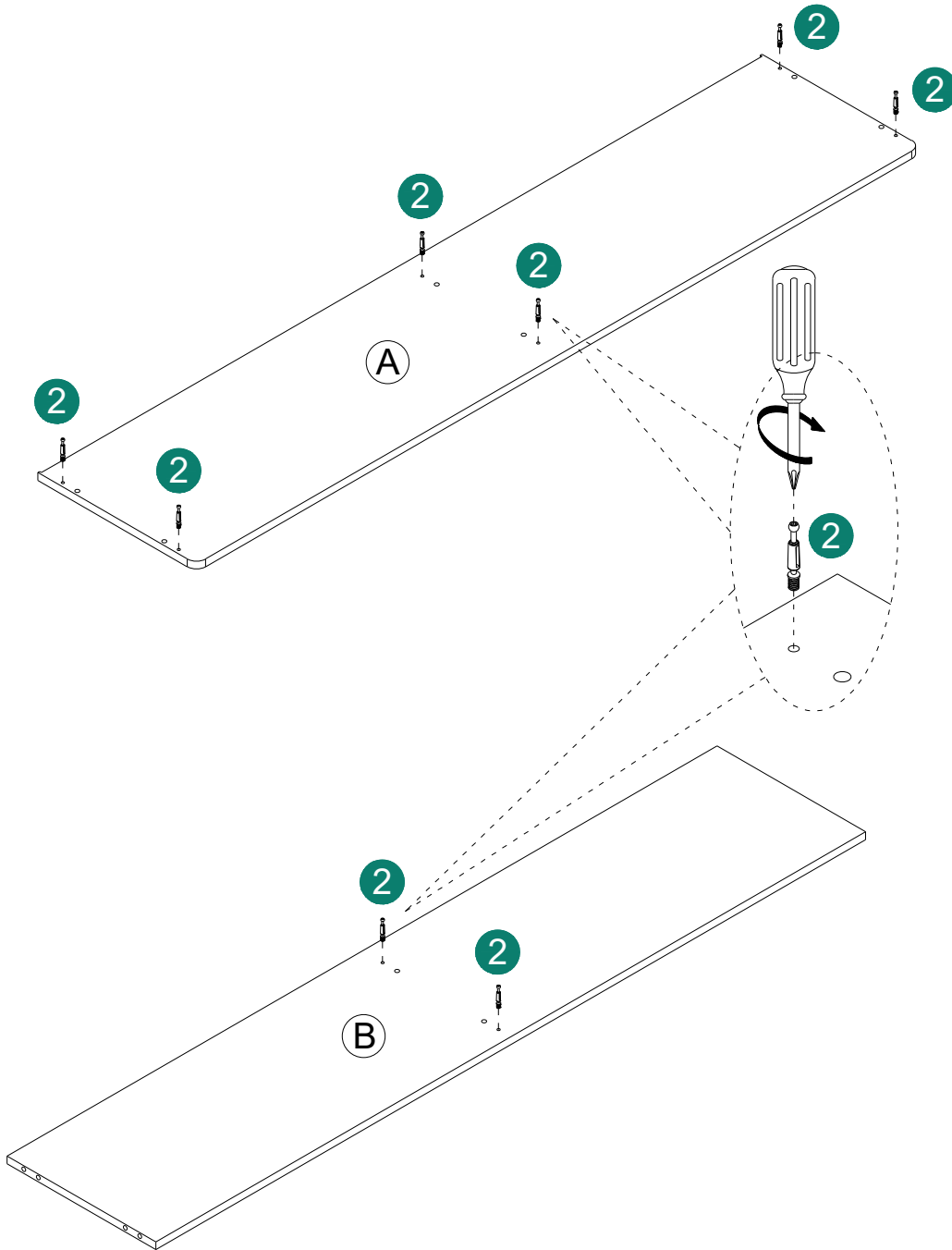

ASSEMBLY INSTRUCTIONS

2

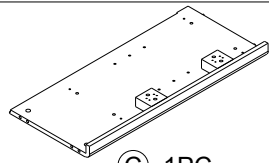

C 1PC

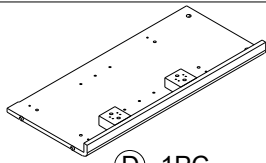

D 1PC

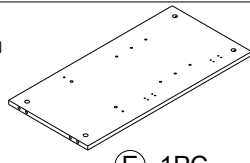

E 1PC



② 12PCS

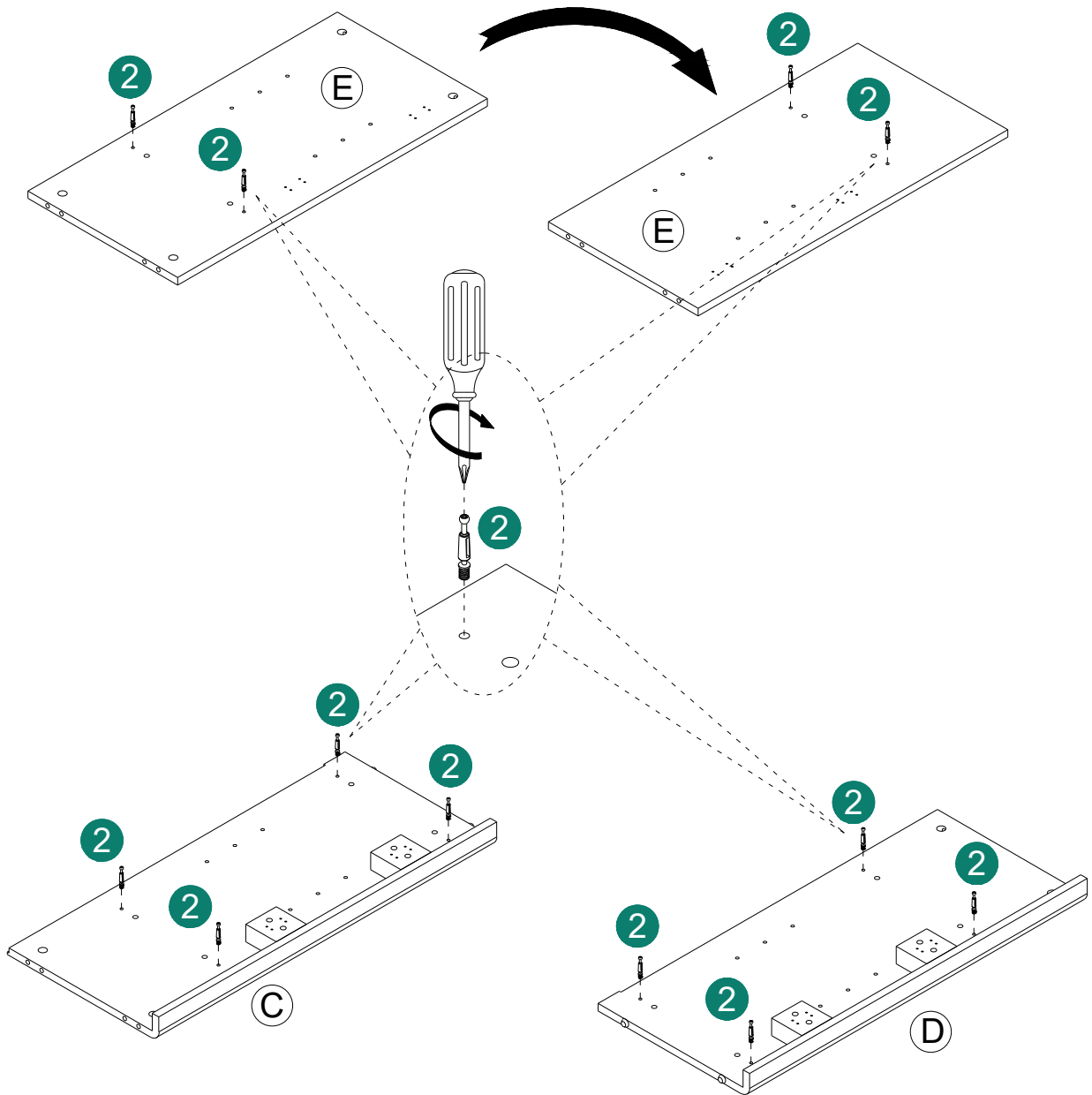

ASSEMBLY INSTRUCTIONS

4

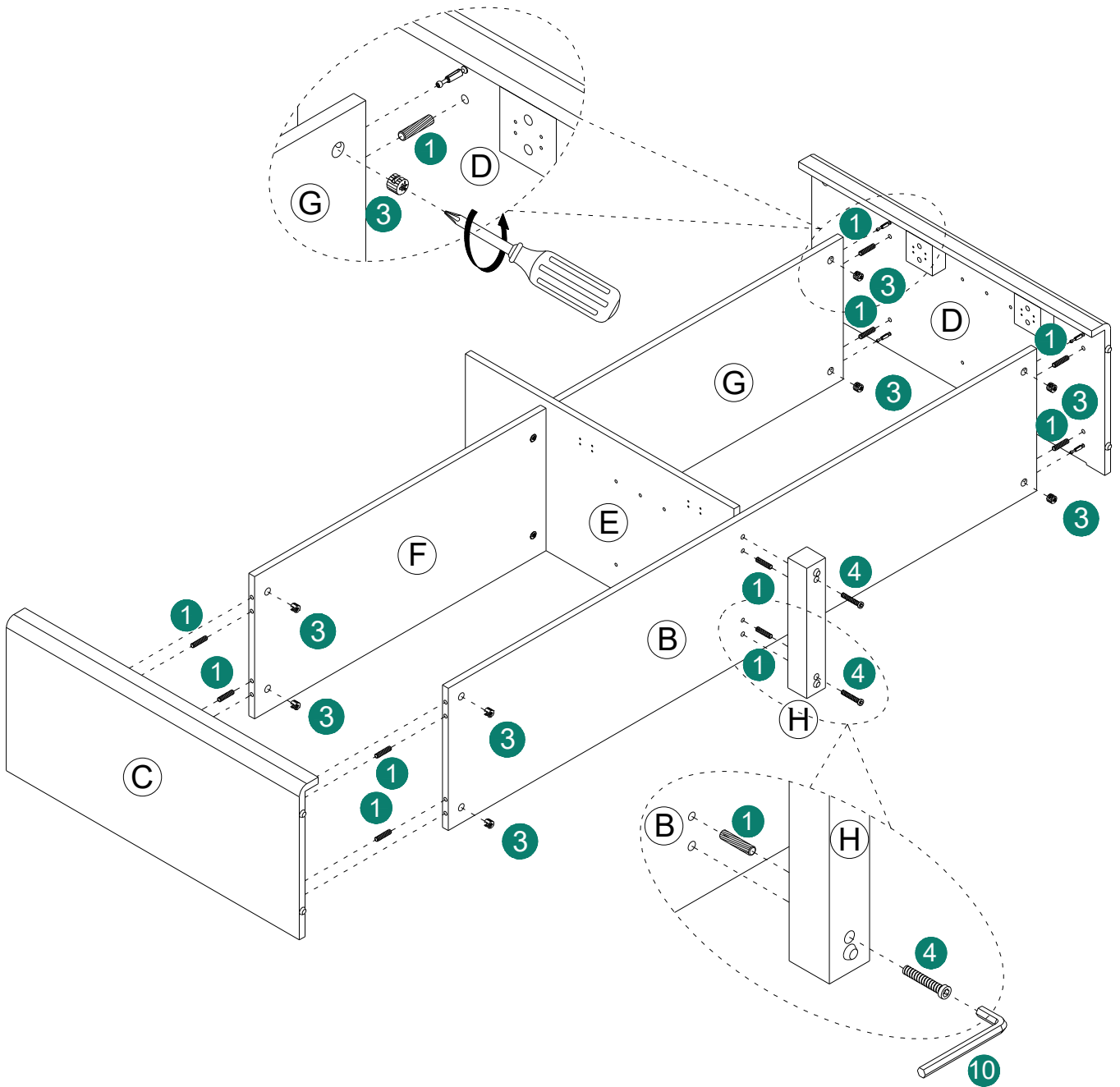
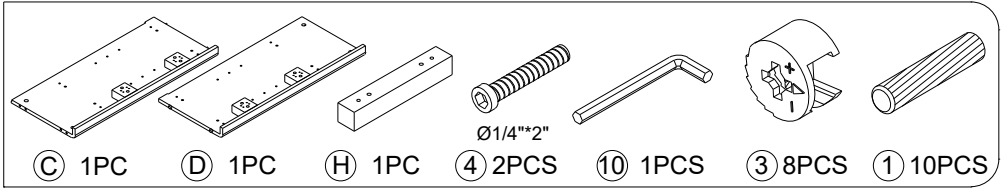

ASSEMBLY INSTRUCTIONS

5

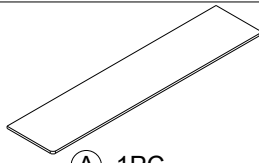

(A) 1PC

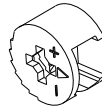

(3) 6PCS

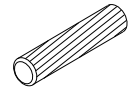

(1) 6PCS

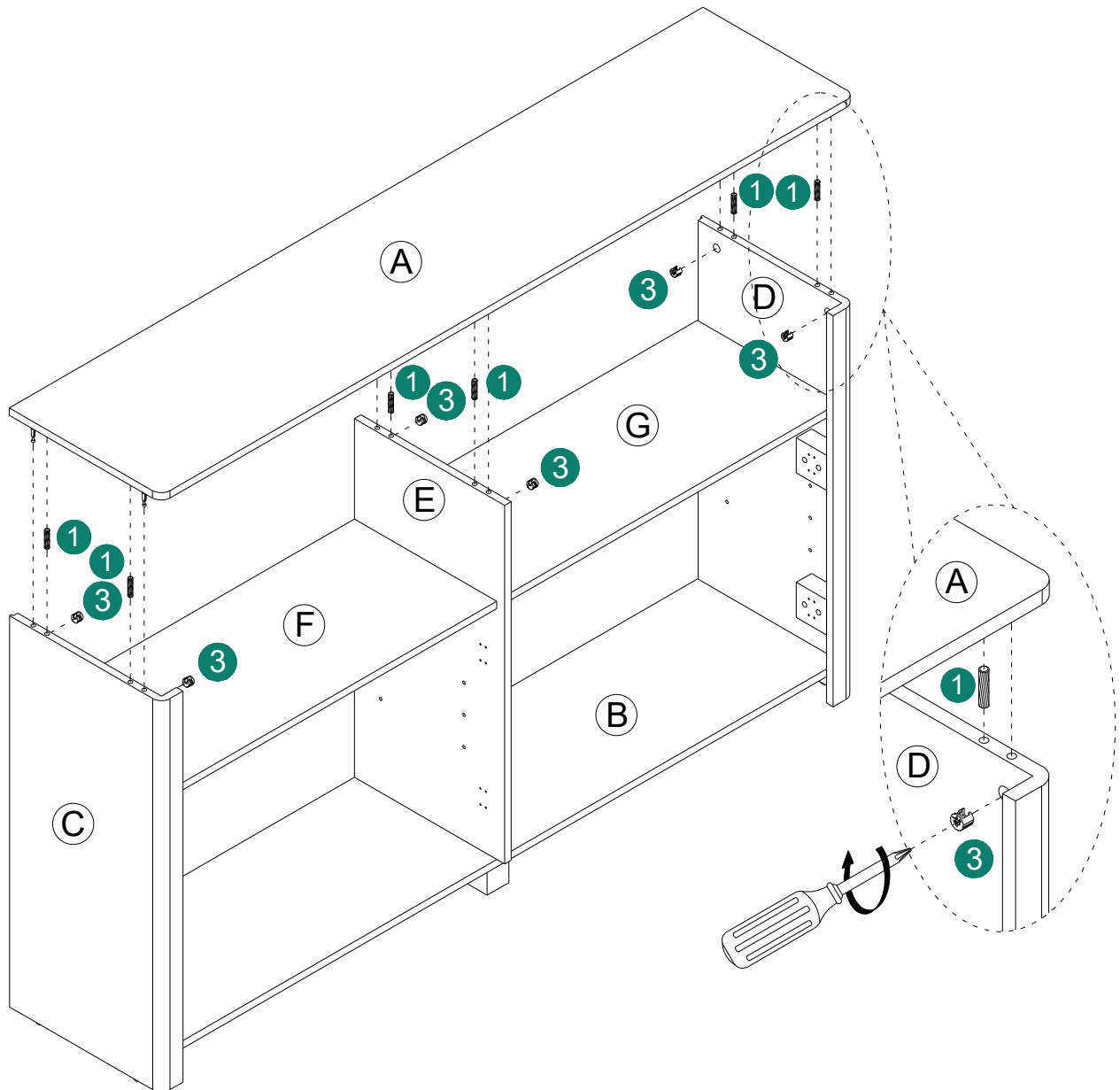

ASSEMBLY INSTRUCTIONS

6

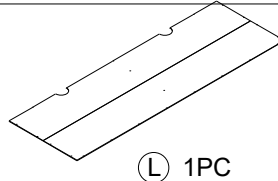
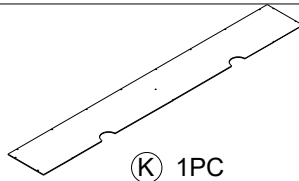

Ø3*15mm

(8) 32PCS

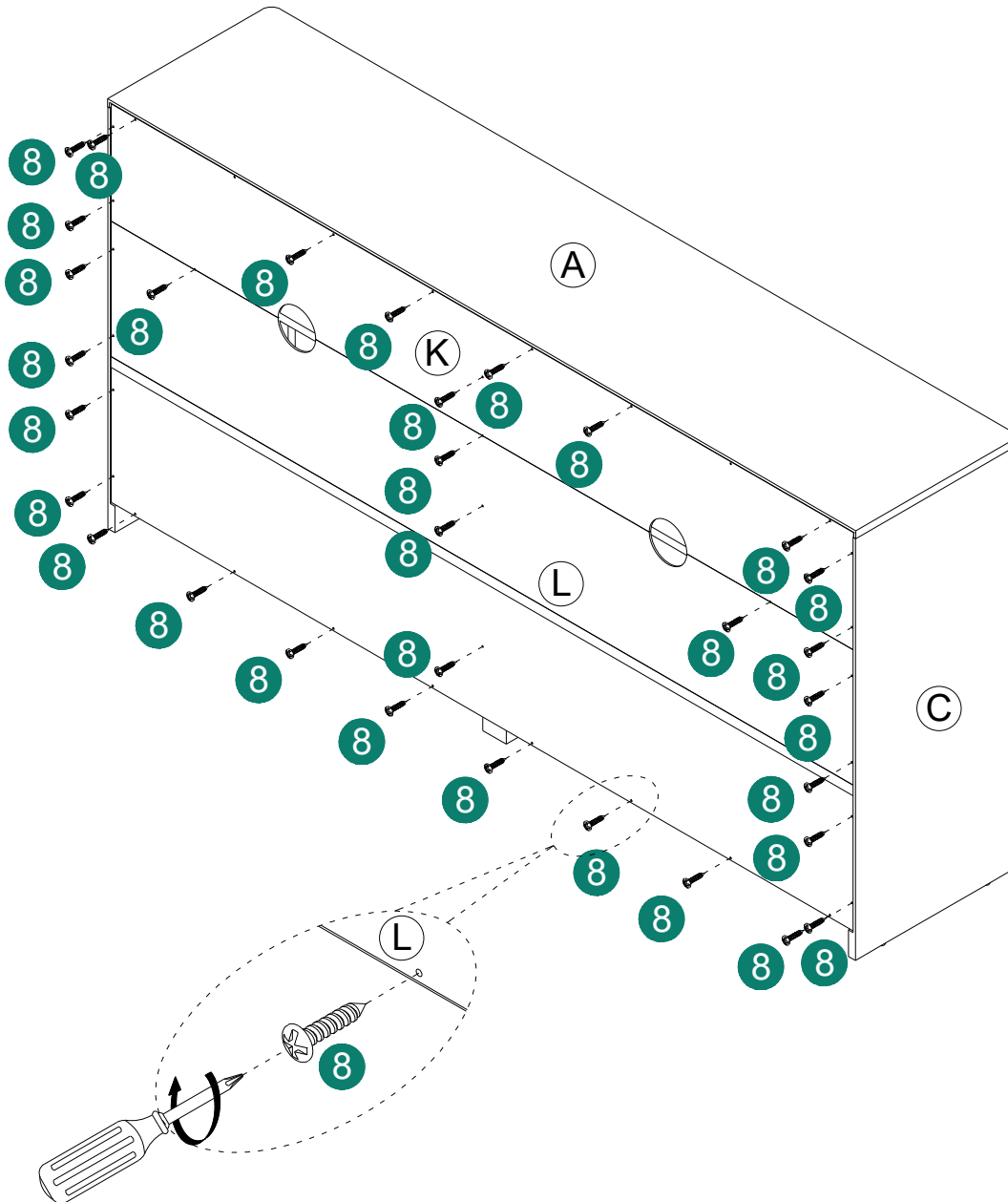

ASSEMBLY INSTRUCTIONS

8

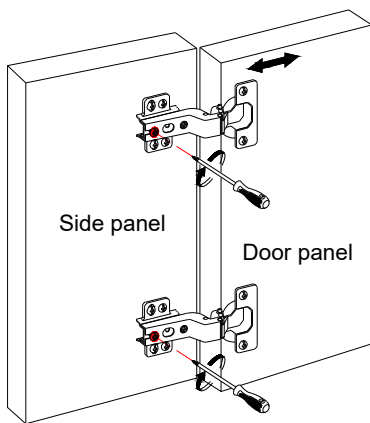

①

Front-to-Back Direction Adjustment:

Rotate the screws on the door hinges shown in the image. The door panel can be moved front-back.

Adjustment range: 4mm

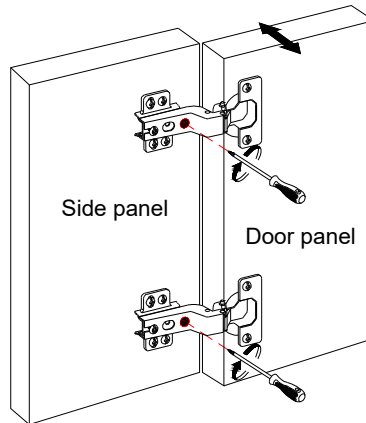

②

Left-Right Direction Adjustment:

Rotate the screws on the door hinges shown in the image. The door panel can be moved left-right.

Adjustment range: 3mm

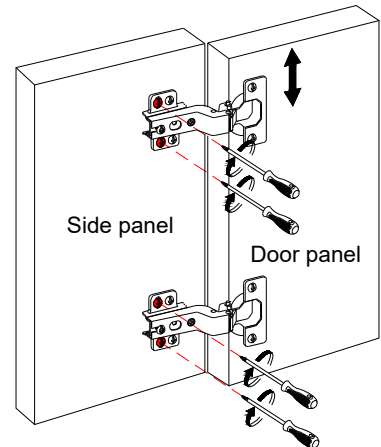

③

Up-Down Direction Adjustment:

Rotate the screws on the door hinges shown in the image. The door panel can be moved up-down.

Adjustment range: 4mm

ASSEMBLY INSTRUCTIONS

9

Common Door Panel Issues:

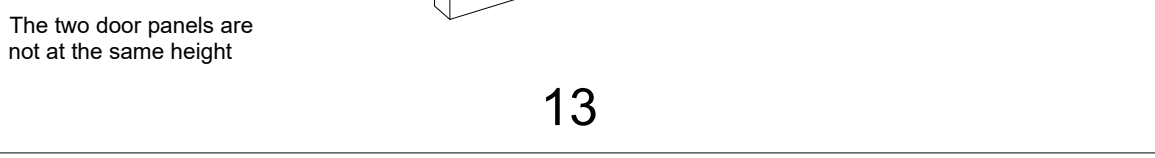
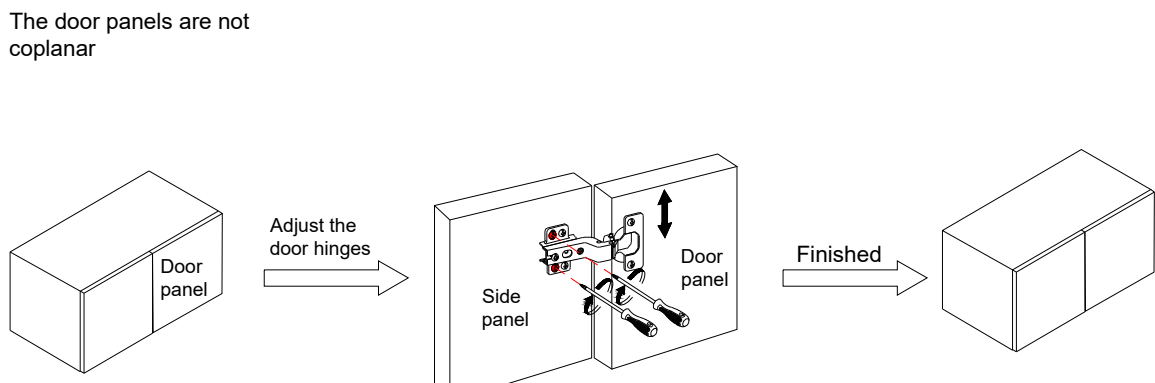
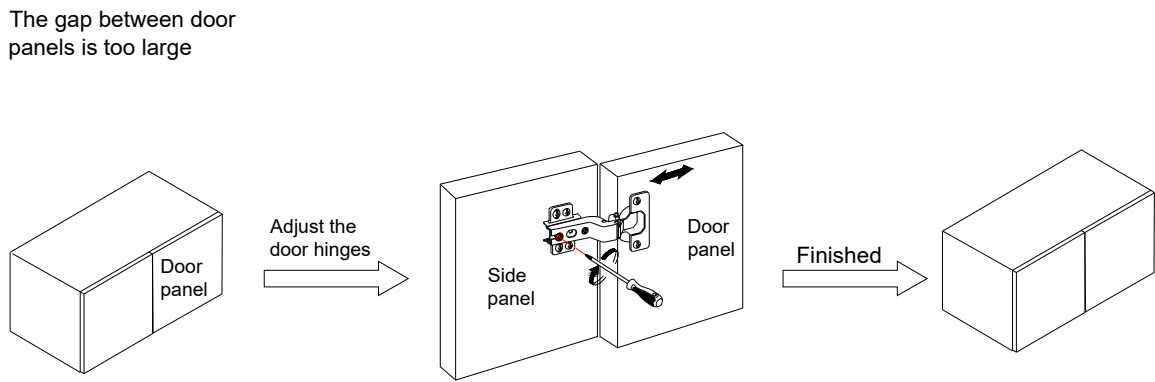
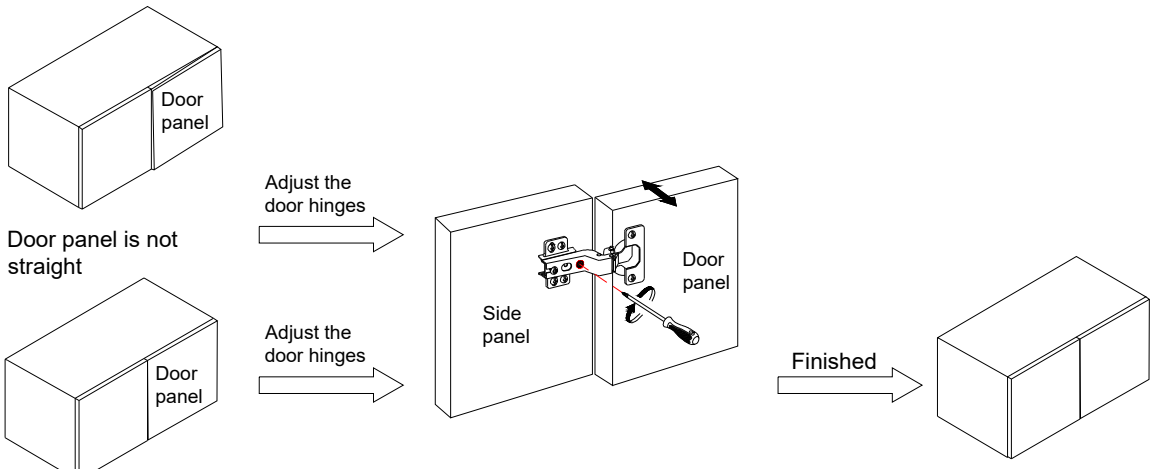

ASSEMBLY INSTRUCTIONS

10

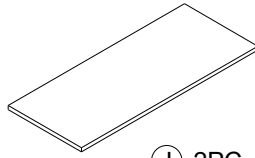

J 2PC



9 8PCS

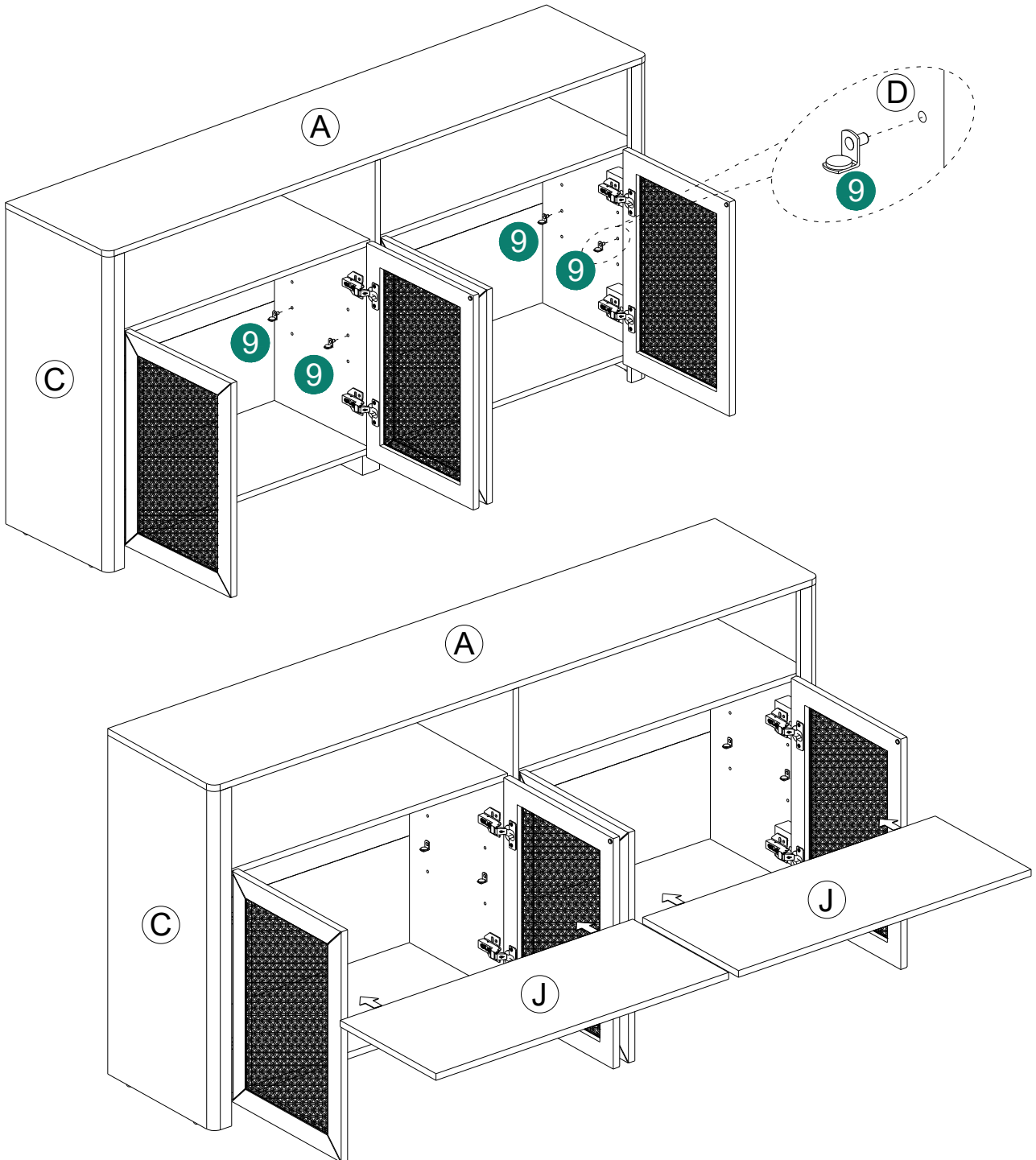

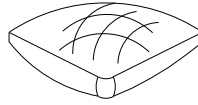

ASSEMBLY INSTRUCTIONS

11

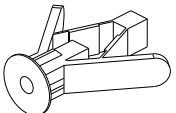

11 2set

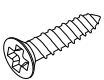
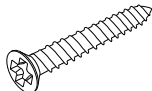
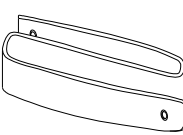
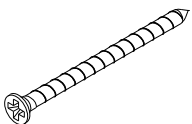
A	B	C	D	E	F
					
3pcs	5pcs	Ø8*3/4" 2pcs	Ø8*1-1/2" 2pcs	2pcs	Ø8*2" 1pcs

