

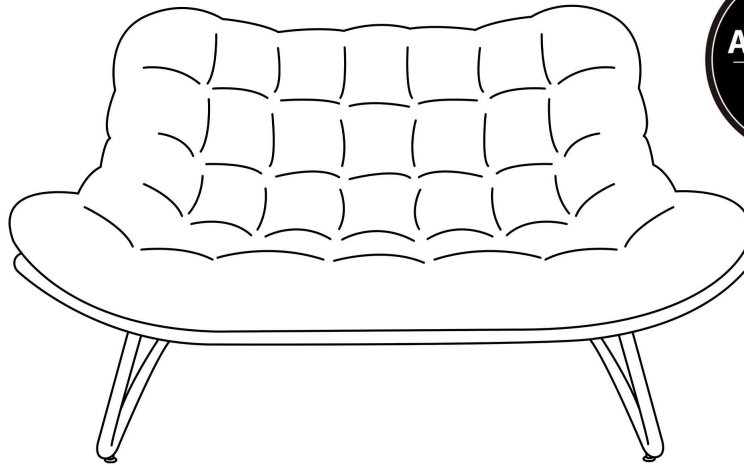

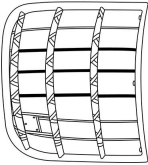

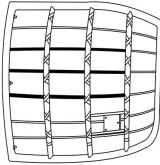

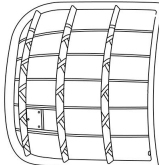
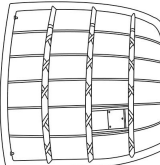

Double Lounge Chair

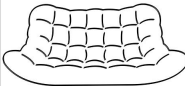
Installation Instructions

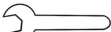
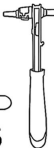

Parts List

Accessories								
	A	1	B	1	C	1	D	1
								
	E	1	F	1	G	1		
Tools								
								
	M6*55mm	11	M8*20mm	12	Hexwrench	H	3	

Tips: Confirm all components are present before installation

Step 1: Assemble the Seat & Backrest Frame

Attach seat parts (A & B) and backrest parts (B & D).

Use 5 screws (M6*55 mm).

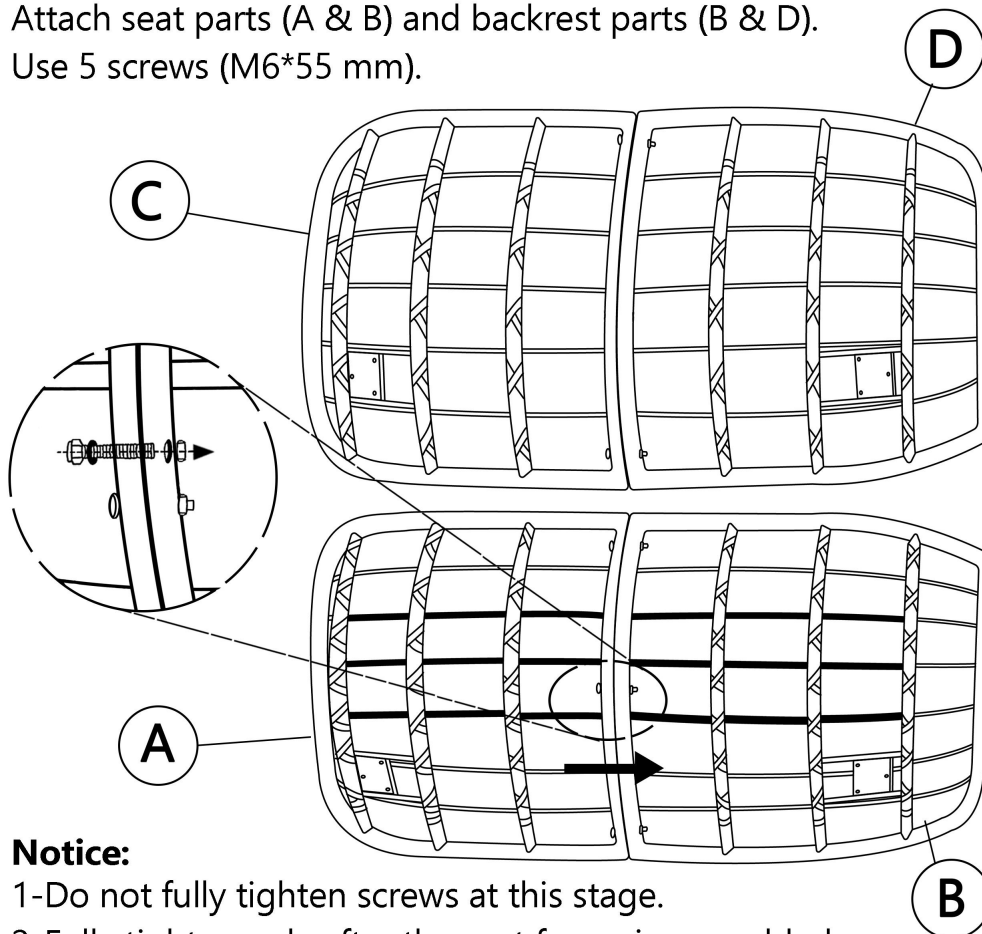

Notice:

1-Do not fully tighten screws at this stage.

2-Fully tighten only after the seat frame is assembled.

Step 2: Connect Side Panels

Join the AC panel and BD panel together.
Use 6 screws (M6*55 mm).

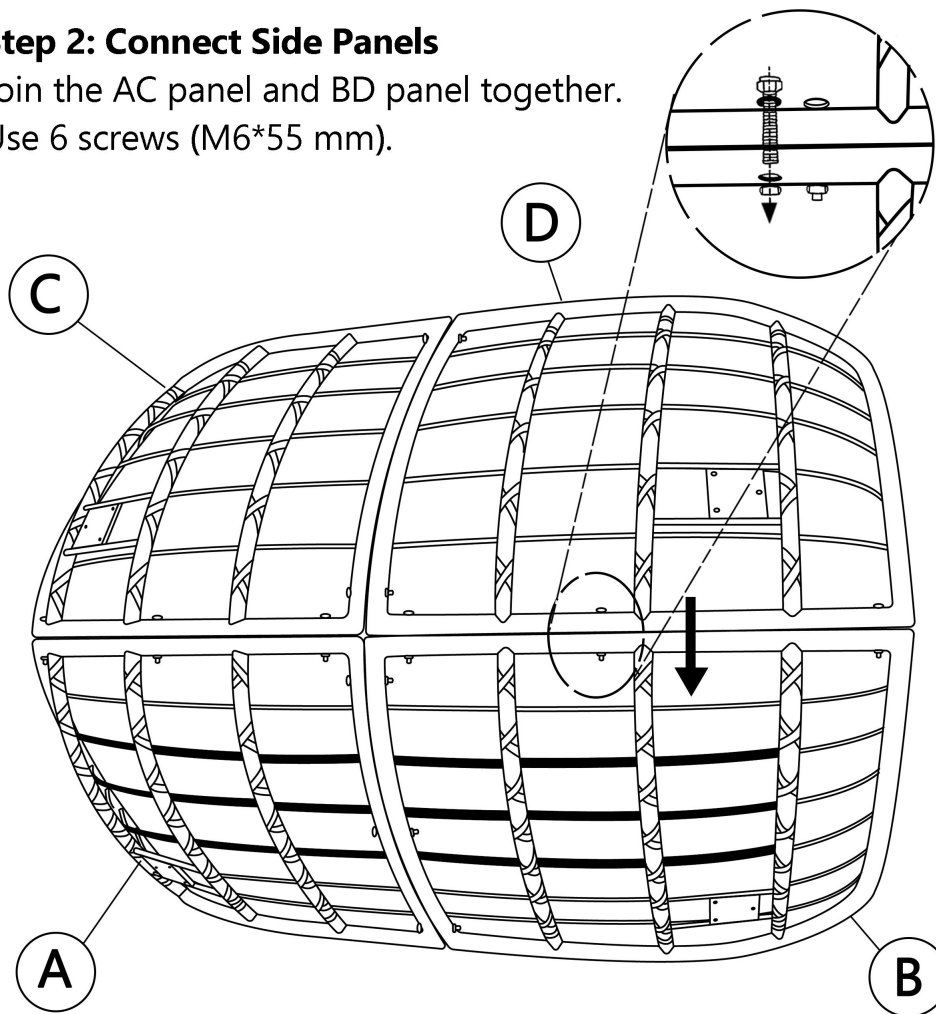

Step 3: Install Support Parts

Attach parts (E & F) to the seat frame.
Use 12 screws (M8*20 mm).

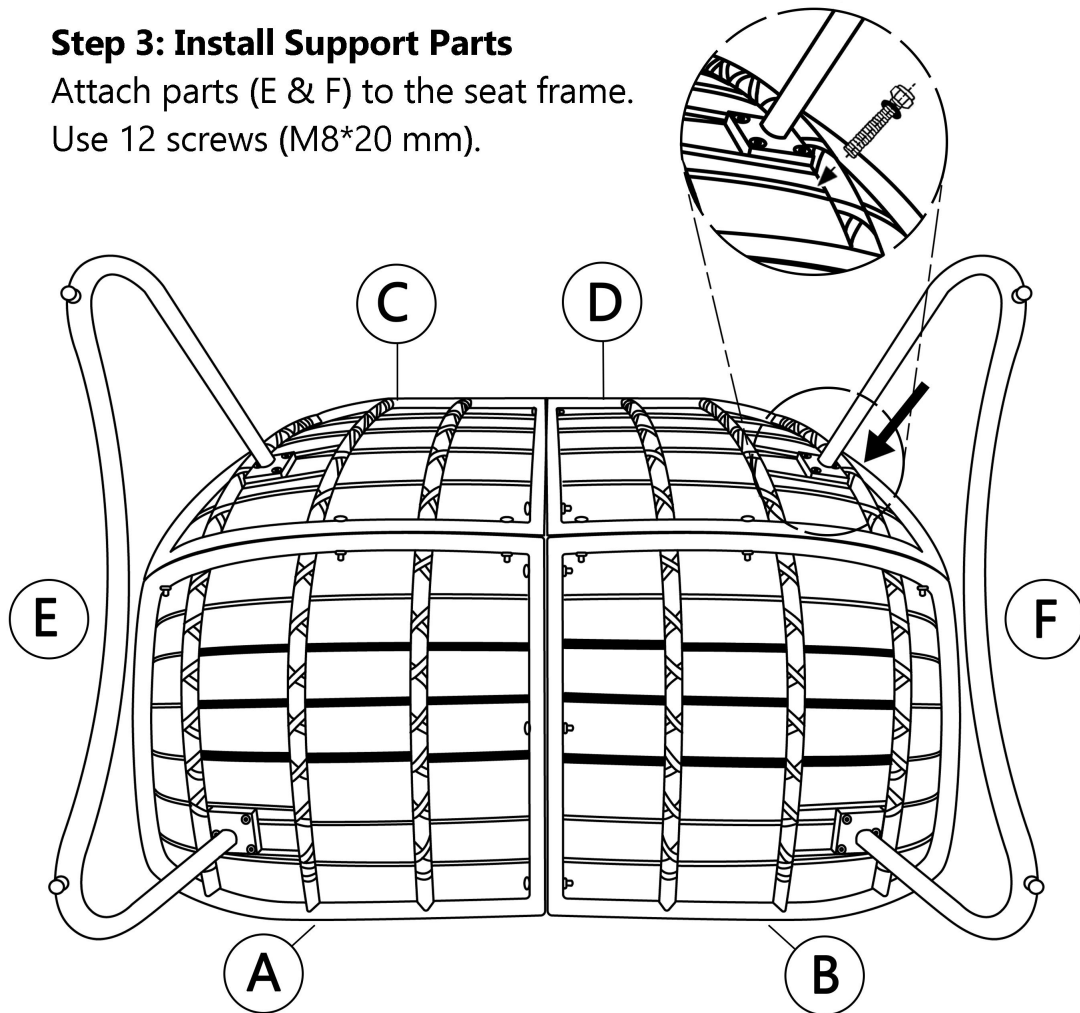

Step 4: Final Assembly

Ensure all screws are securely tightened.

Place the cushion on the chair.

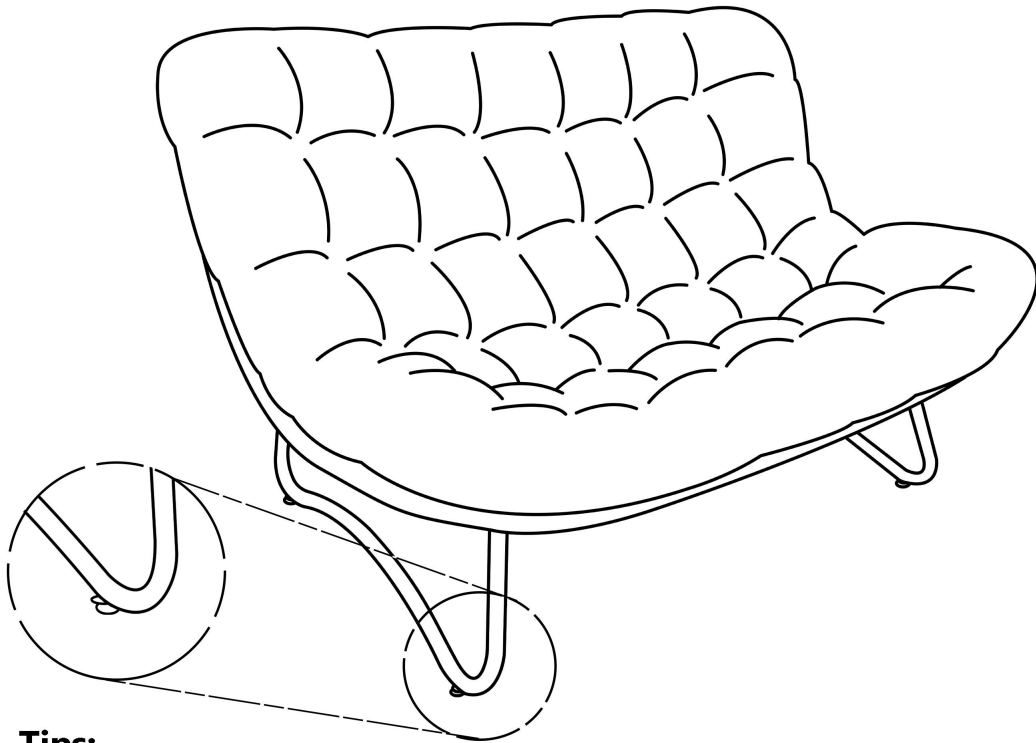

Tips:

If the chair feels wobbly after assembly,
adjust the height adjusters on the four legs until stable.

Double Lounge Chair

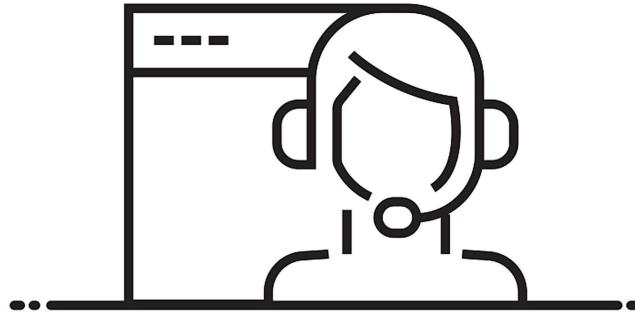

ONLINE SUPPORT

Please read the installation guide carefully before installation
If you have any questions during the installation process
you can contact us and we will provide you a detailed guidance