

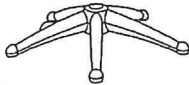











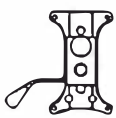

Assembly instructions

① X 1	A.M6*25 X 4
	
② X 1	B.M6*20 X 4
	
③ X 1	C.M6*40 X 4
	
④ X 1	D.X 4
	
⑤ X 1	E.X 1
	
⑥ X 1	F.X 5
	
⑦ X 1	G.X 2 H.X 2
	 
⑧ X 1	
	

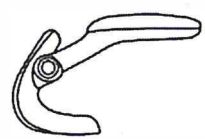
STEP 1

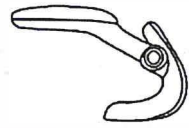

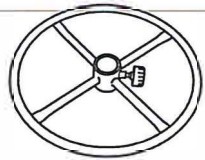
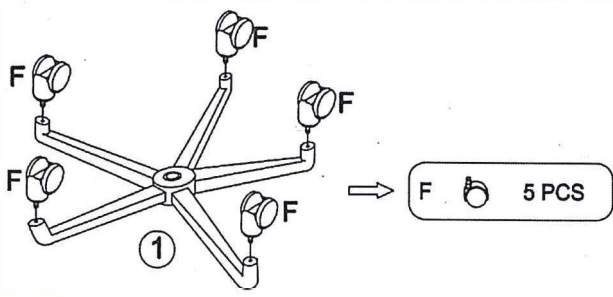
STEP 2

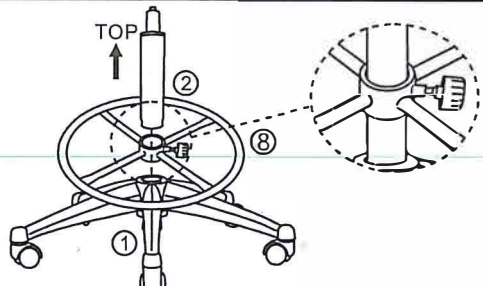

STEP 3

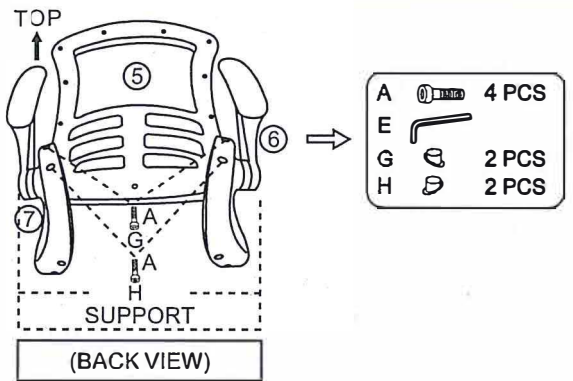

STEP 4

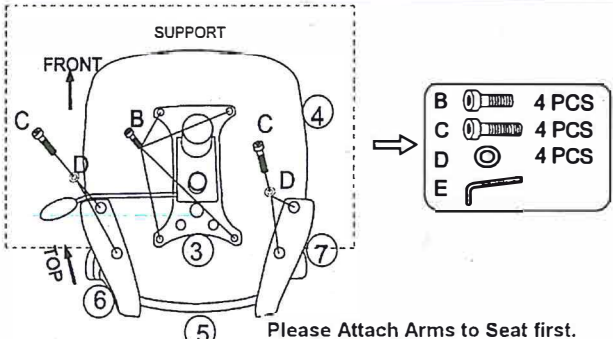

STEP 5

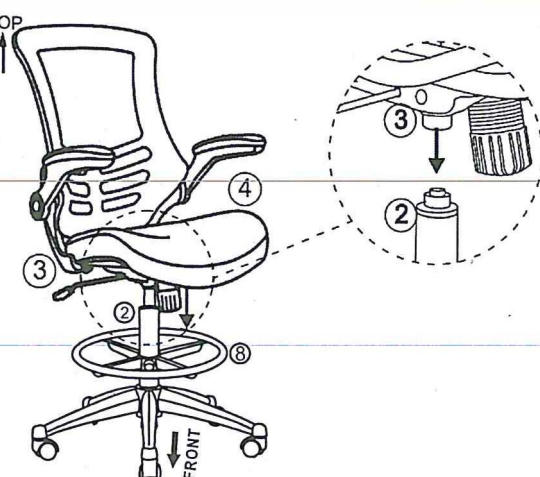

NOTICE:
EVERY 6 MONTHS, PLEASE MAKE SURE ALL BOLTS, SCREWS AND KNOBS ARE FULLY TIGHTENED TO ENSURE STABILITY.