

INSTALLATION MANUAL

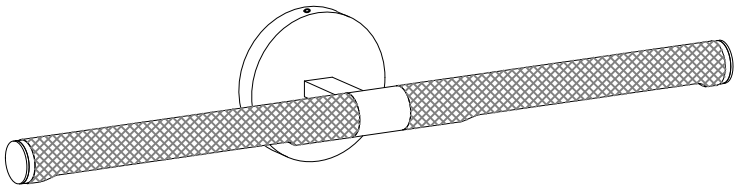







This manual only shows the installation steps for one size, and the installation methods for other sizes of products are similar.

Now, let's complete this light together.

Be patient

and fully utilize your artistic talent

What awaits you after completion is incredible beauty!

| | | | |
|--|--|--|--|
| <p>A*3</p>  | <p>B*1</p>  | <p>C*3</p>  | <p>D*3</p>  |
| <p>E*2</p>  | <p>F*1</p>  | <p>G*2</p>  | <p>H*1</p> |
| <p>I*1</p> | <p>J*1</p> | <p>K*0</p> | <p>L*0</p> |
| <p>M*0</p> | <p>N*0</p> | <p>O*0</p> | <p>P*0</p> |
| <p>Q*0</p> | <p>R*0</p> | <p>S*0</p> | <p>T*0</p> |

STEP I Unpacking

Open the box, and take out all the accessories, you will get the following items.

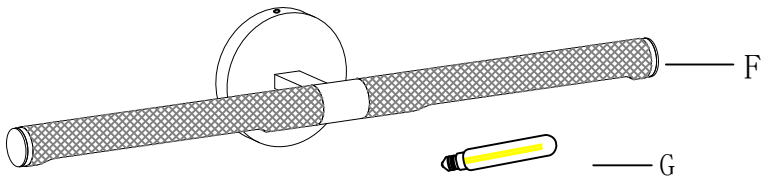
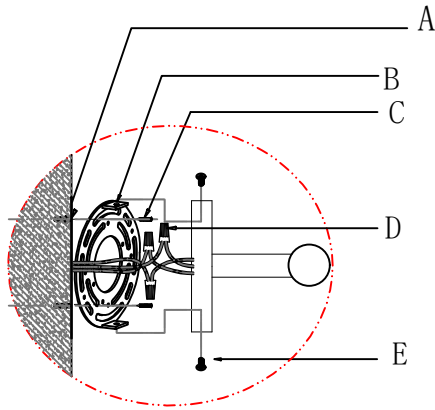

FAQ

Q:When I opened the box,I found some hanging parts were broken.

A:The hanging parts are inherently fragile,and we have considered this situation.We have prepared spare hanging parts in each box,which is enough for your installation.

STEP II Branch Adjustment

1. Adjust the length of hanging cable and wire according to your requirement.
2. Take off the mounting bracket from ceiling canopy, and install it on ceiling.
3. Connect lamp wires and your house wires together.
4. Install the lamp frame on ceiling.

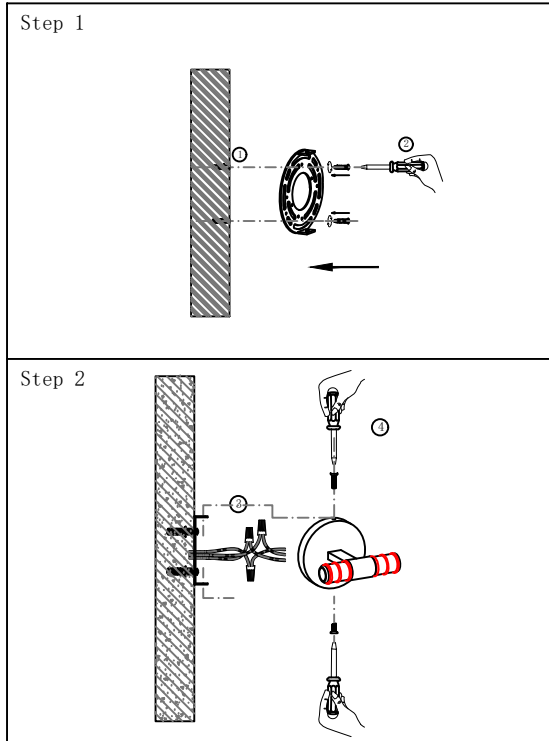

FAQ

Q: How do I differentiate between Neutral wire, Live wire and Ground wire?

A: We have distinguished markings between the N and L wires and the brass wire on the mounting bracket is the ground wire.

STEP III Wiring and Mounting

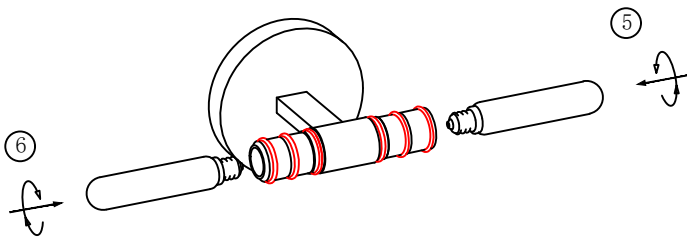

FAQ

Q: What if the bulb is not vertical when installing?

A: We can loosen the bulb to fine-tune the angle. Ensure the light bulb is vertical when being locked! So that the light bulb will not touch the inner wall of the lampshade!

STEP IV Hanging Pendants

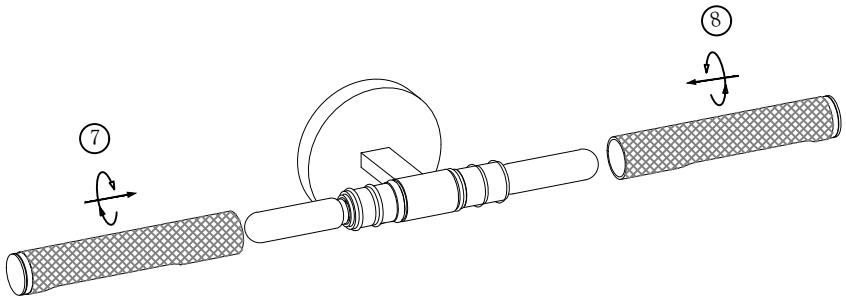

FAQ

Q:What do I need to pay attention to when installing a metal lampshade?

A:Due to the silicone ring on the metal lamp body, you need to screw the shade into the lamp body in order to better install the metal lampshade and keep the shade matching the lamp body.

Please note:

Please check the parts list firstly, if there are any parts missing during your actual installation, contact us immediately, we will help you in time!

No matter what problems or questions you encounter during the installation or use of the chandelier, please feel free to contact us, we will reply to you within 24 hours and quickly solve or answer for you!
When you leave a message to us online, please leave your order ID and case details. The more detailed and accurate descriptions you provide, the faster and more accurate solutions we will offer!

SAFETY INSTRUCTIONS

These instructions are provided for your safety. It is very important that you read the instructions completely before starting the installation of your fixture.

1. We recommend installation by a licensed electrician .
2. This fixture require E12 bulbs(INCLUDED) and bulb rated wattage: Max 10W. Low wattage LED bulbs are recommended. To avoid risk of fire, do not exceed the recommended wattage.
3. If any special control devices are used with this fixture, follow the instructions carefully to assure full compliance with N.E.C. requirements. If there are any problems, contact a qualified electrical contractor.
4. Please ensure that you shut off the main electrical supply before installation, changing bulbs or cleaning light fixture.

WARNINGS

This is not a toy and the product has no play value.
Keep at least 3 feet away from cribs, bassinets and toddler beds.
Keep out of reach of children under 3 years of age.



PREPARATION

1. Please prepare the E12 bulbs in the package in advance.
2. Please keep the installation position clean and tidy so as not to miss the small accessories.