

# ASSEMBLY INSTRUCTION

**A**

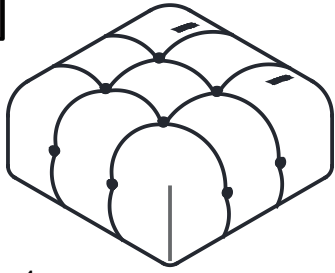

1pc

**B**

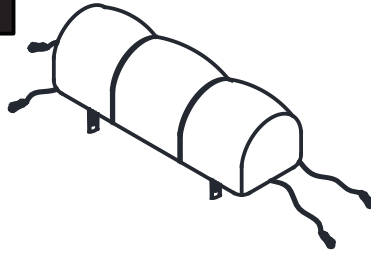

1pc

**C**

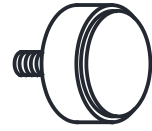

4pcs

**1**

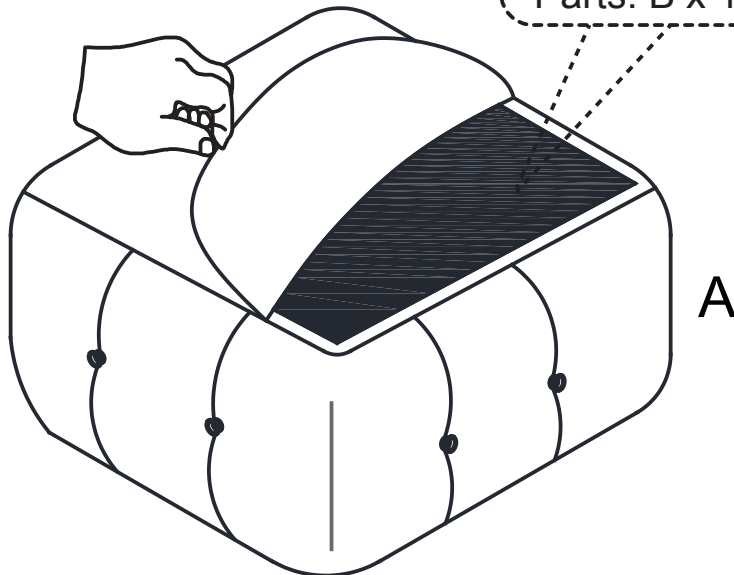
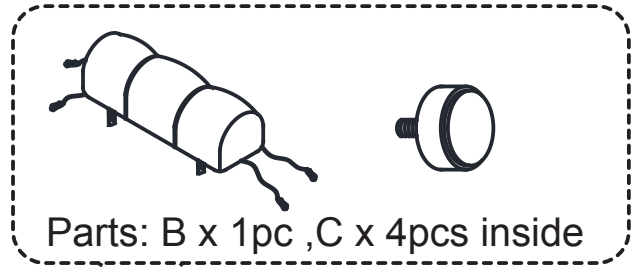

**2**

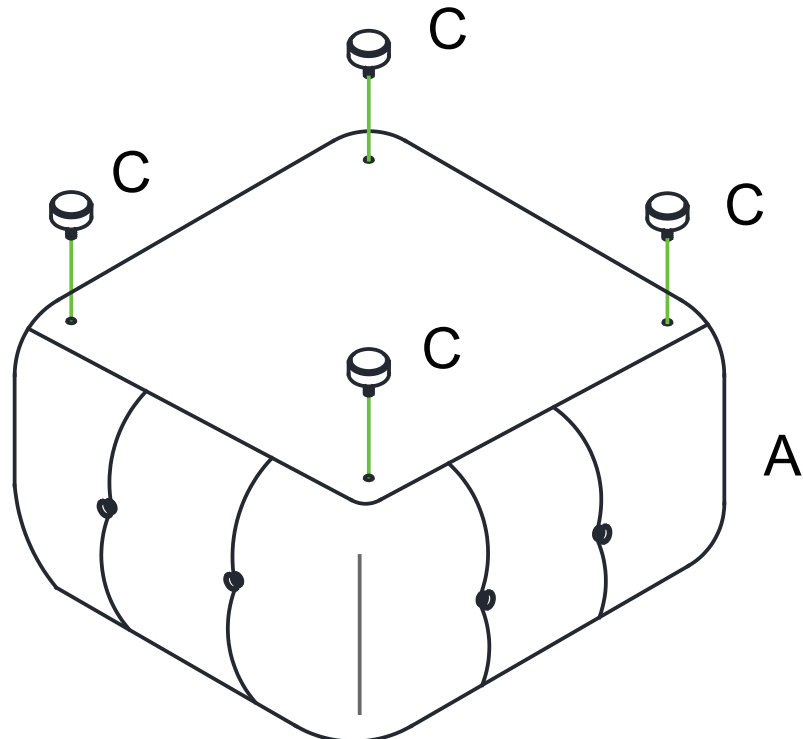

3

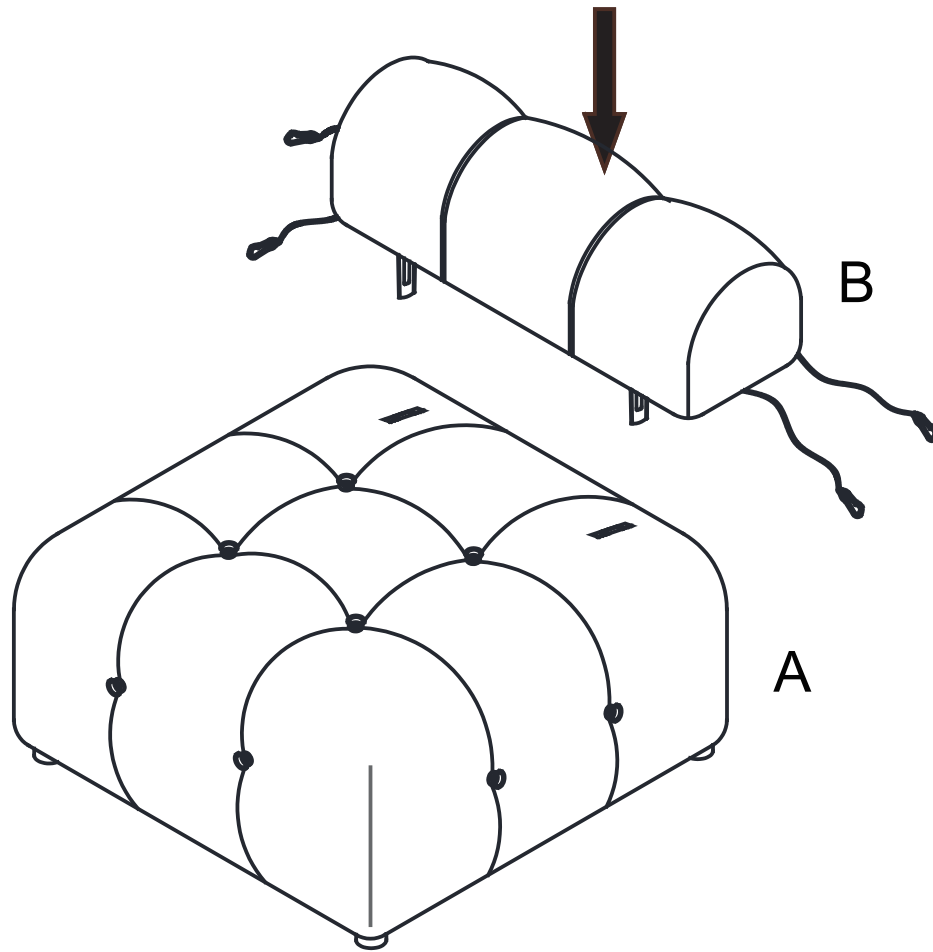

4

