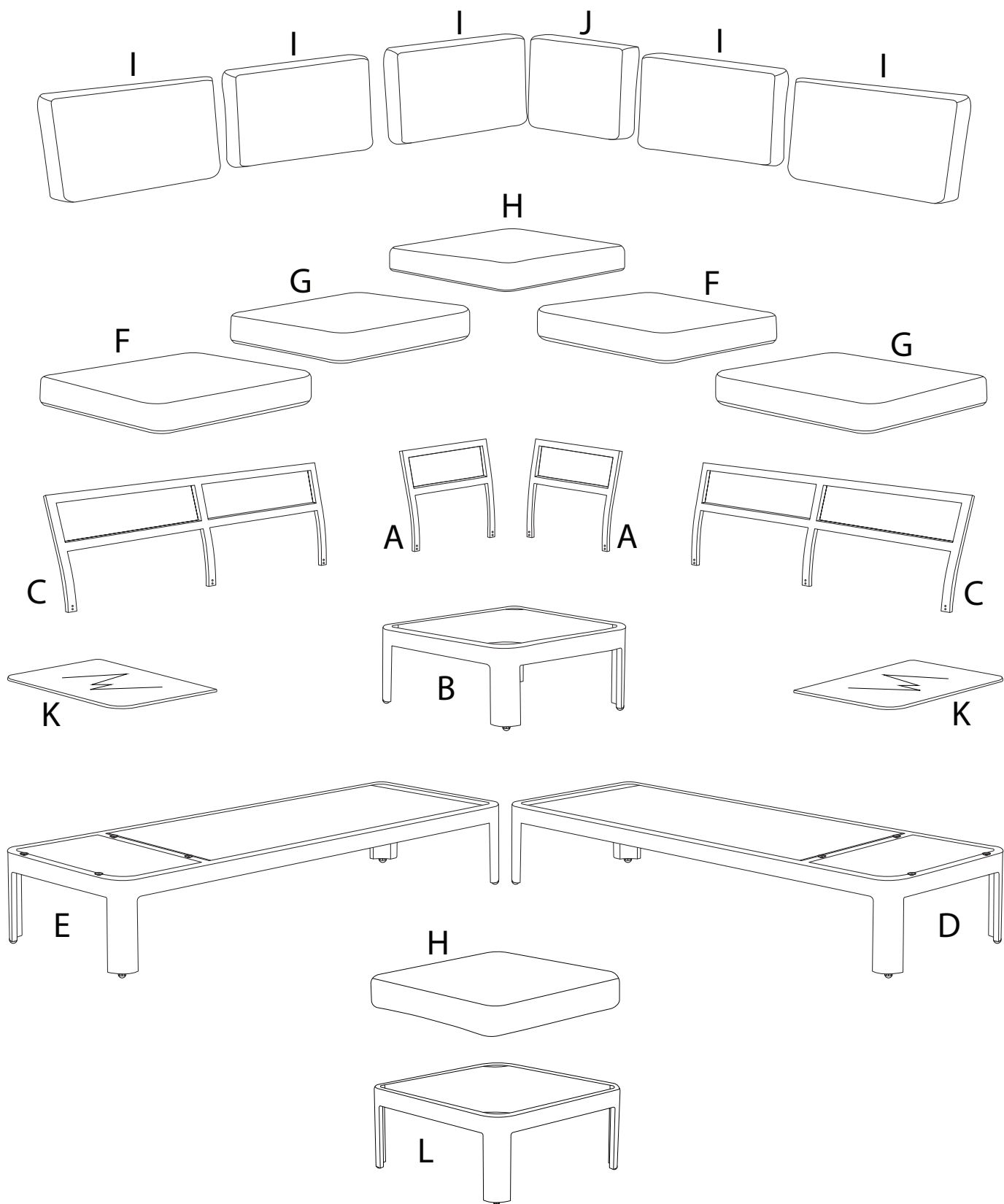
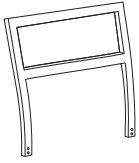
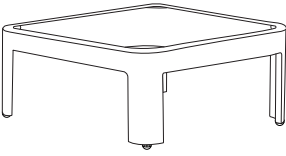
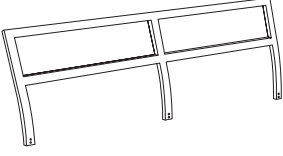
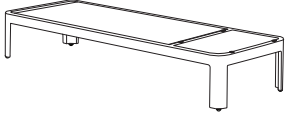
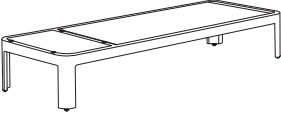

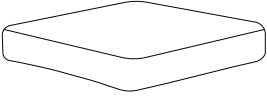
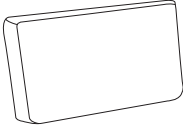
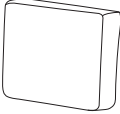

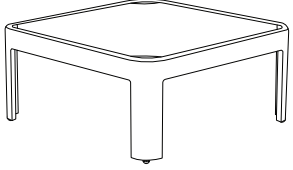

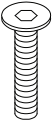
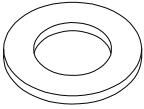



Diagram illustrating assembly instructions and warnings:

- Warning 1:** A warning triangle with an exclamation mark is positioned above a box containing an L-shaped metal bracket and a power drill with a slash through it, indicating that a power drill should not be used for this step.
- Warning 2:** A second warning triangle with an exclamation mark is positioned above a box containing a rectangular block being placed on a textured surface and another block being placed on a flat surface with a slash through it, indicating that the block should be placed on a textured surface.
- Time:** A clock icon is shown next to the text "20'", indicating a 20-minute assembly time.
- Person:** An icon of a person is shown next to the number "1", indicating that one person is required for assembly.



<p>A</p>  <p>x 2</p>	<p>B</p>  <p>x 1</p>	<p>C</p>  <p>x 2</p>	<p>D</p>  <p>x 1</p>
<p>E</p>  <p>x 1</p>	<p>F</p>  <p>x 2</p>	<p>G</p>  <p>x 2</p>	<p>H</p>  <p>x 2</p>
<p>I</p>  <p>x 5</p>	<p>J</p>  <p>x 1</p>	<p>K</p>  <p>x 2</p>	<p>L</p>  <p>x 1</p>
<p>AA</p>  <p>x 20</p>	<p>BB</p>  <p>M6 x 35</p> <p>x 20</p>	<p>CC</p>  <p>x 20</p>	<p>DD</p>  <p>x 1</p>

1

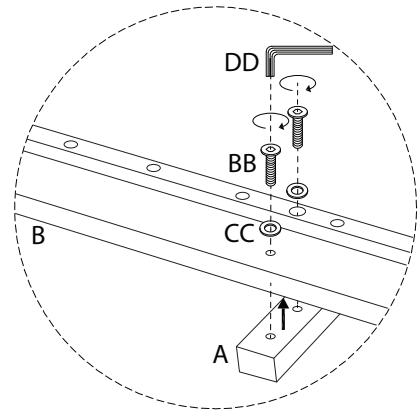
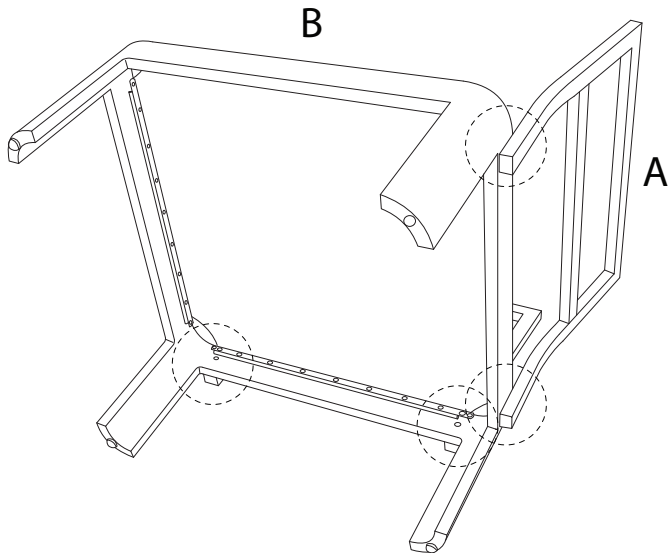
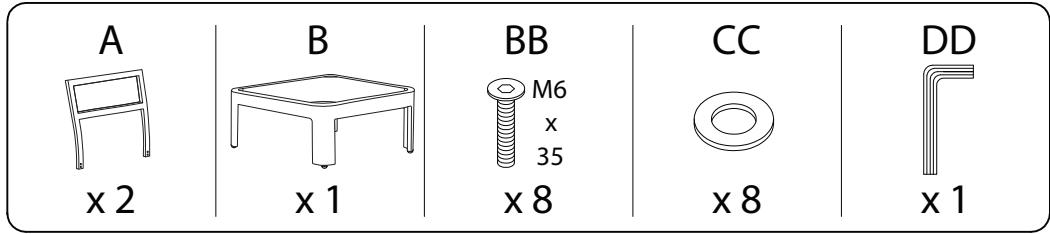

2

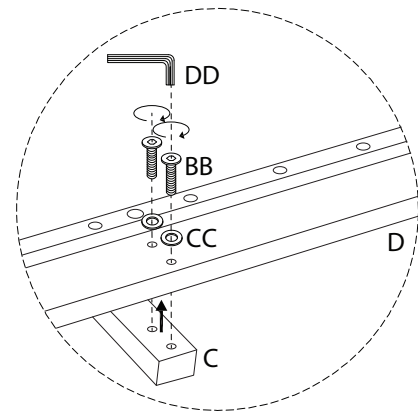
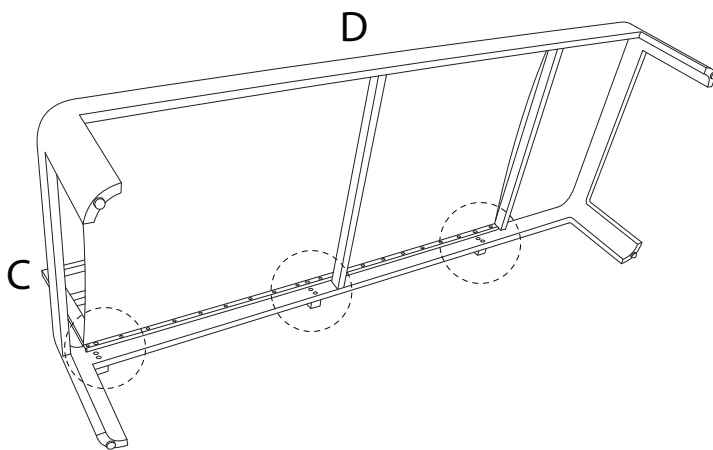
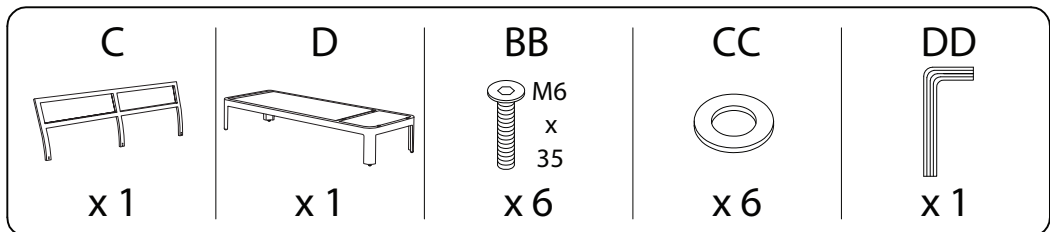

3

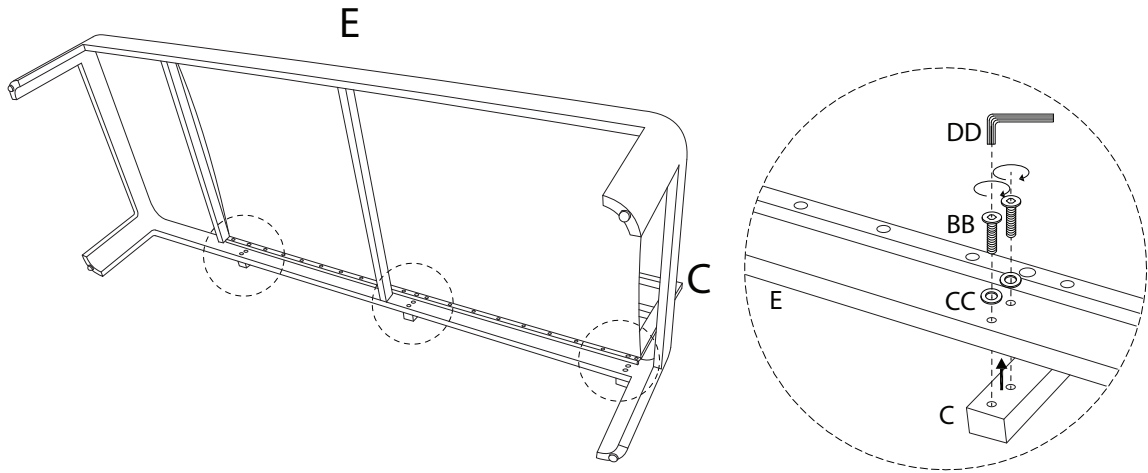
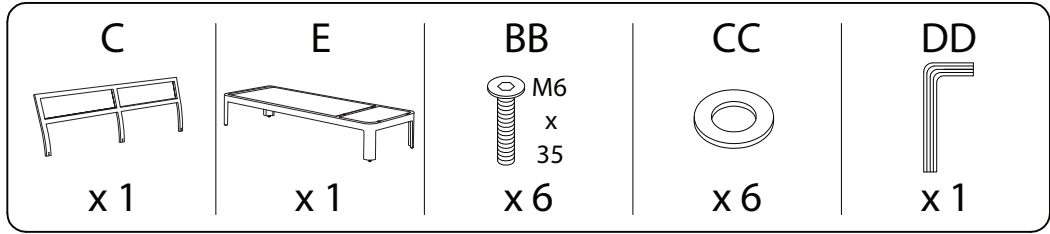

4

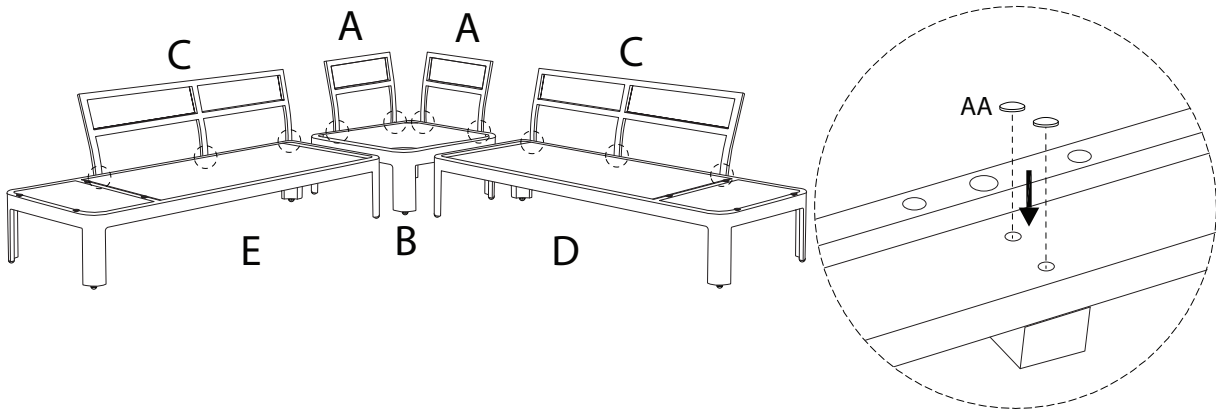
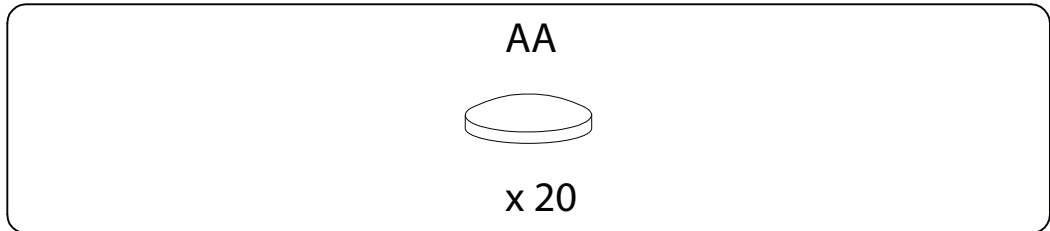

5

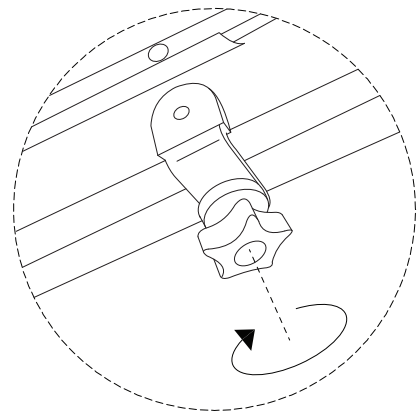
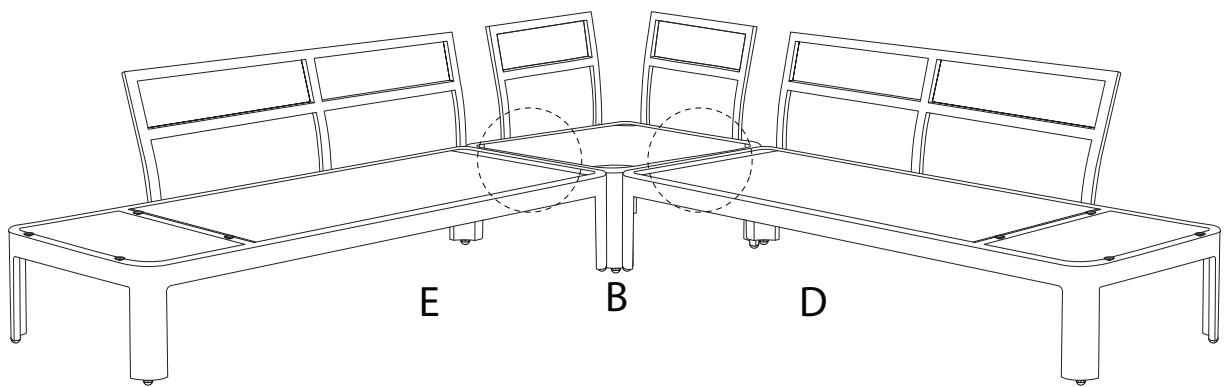

6

K



x 2

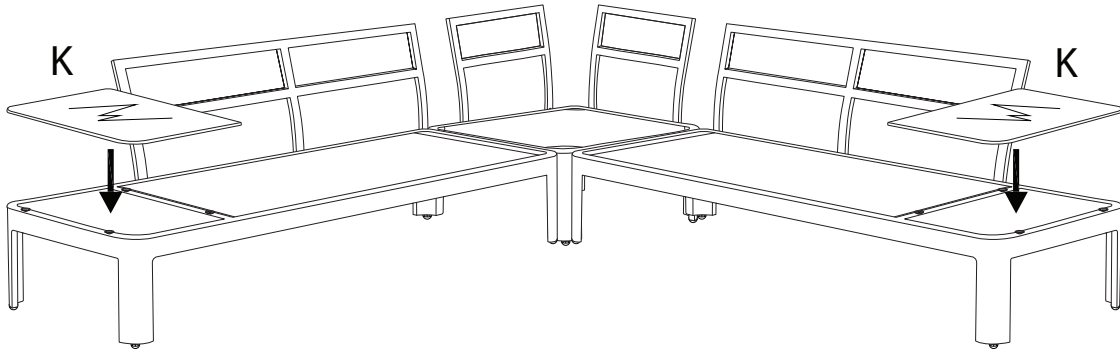

7

L

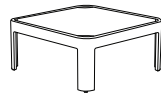

x 1

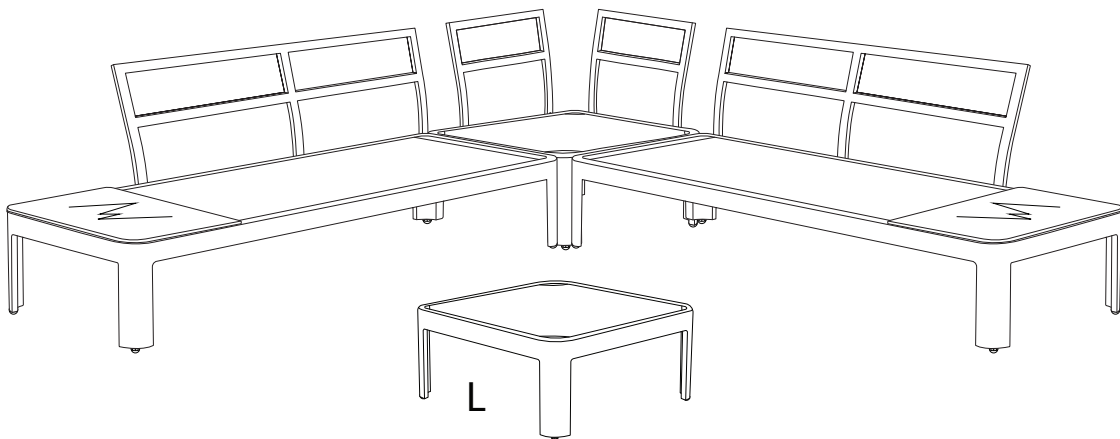

8

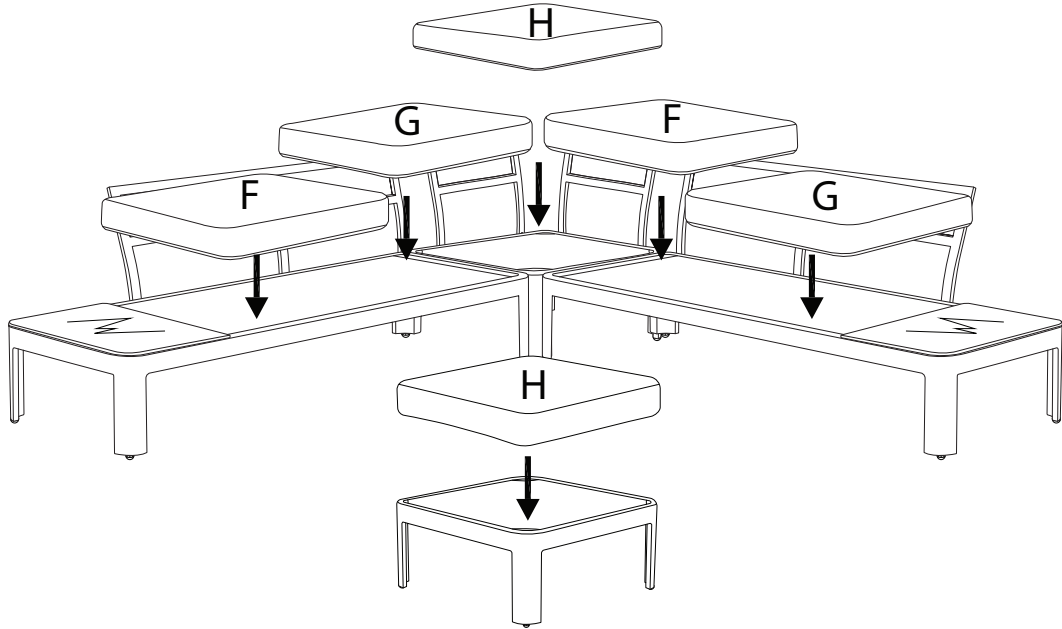
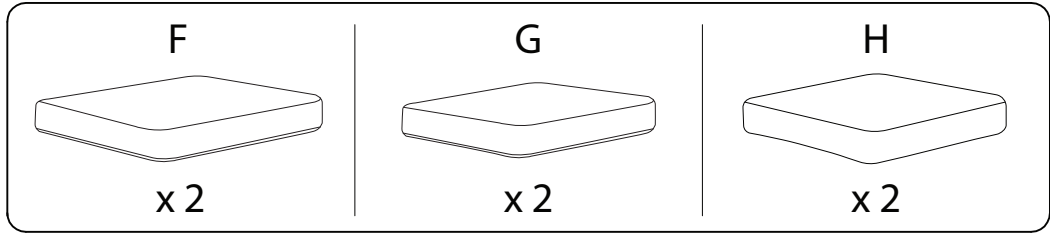

9

