

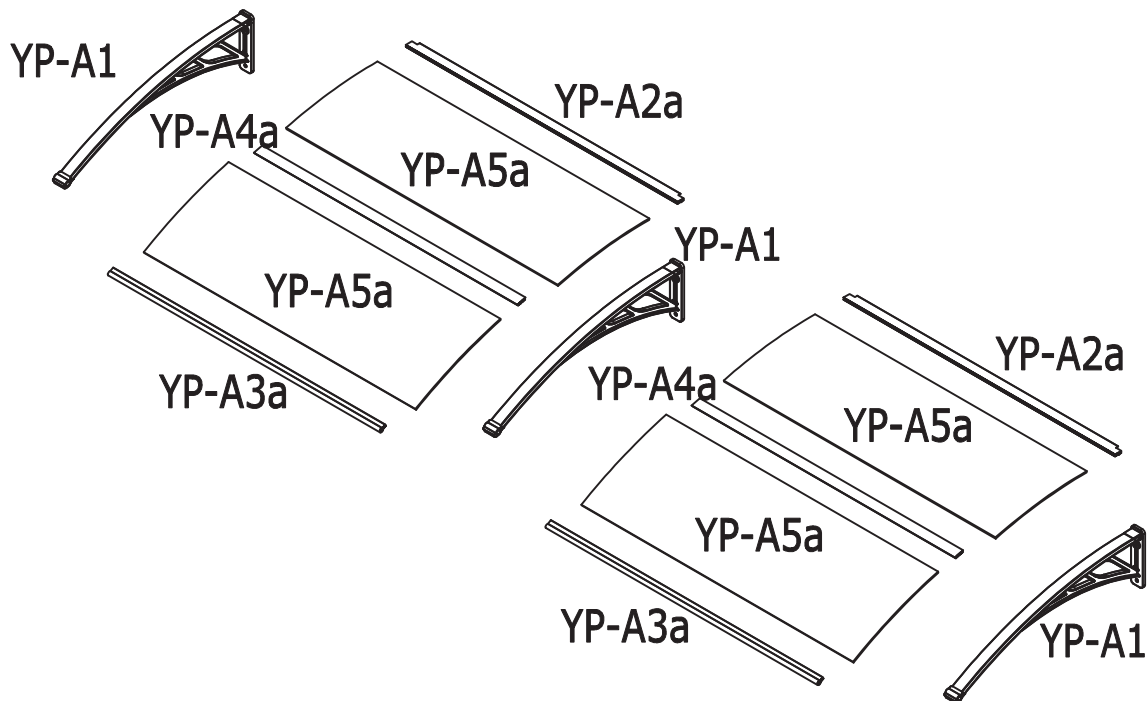







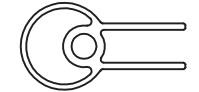

READ AND SAVE THIS INSTRUCTIONS FOR FUTURE USE

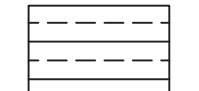
# ASSEMBLY & INSTRUCTION MANUAL



|        |   |           |    |     |
|--------|---|-----------|----|-----|
| YP-A1  |   | 800mm     | x3 | 1/1 |
| YP-A2a |  | 970mm     | x2 | 1/1 |
| YP-A3a |  | 970mm     | x2 | 1/1 |
| YP-A4a |  | 934mm     | x2 | 1/1 |
| YP-A5a |  | 970X393mm | x4 | 1/1 |
| YP-D6  |  | M5X16mm   | x6 | 1/1 |
| YP-D7  |  | ST8X60mm  | x6 | 1/1 |
| YP-D8  |  |           | x6 | 1/1 |
| YP-D9  |  | ST4X13mm  | x2 | 1/1 |
|        |  |           | x1 | 1/1 |

01

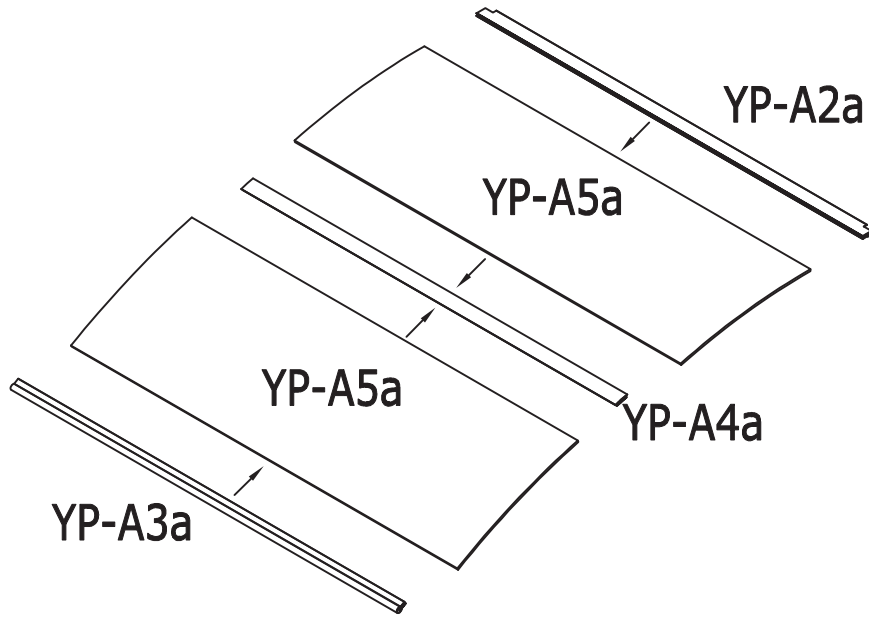

x2

02

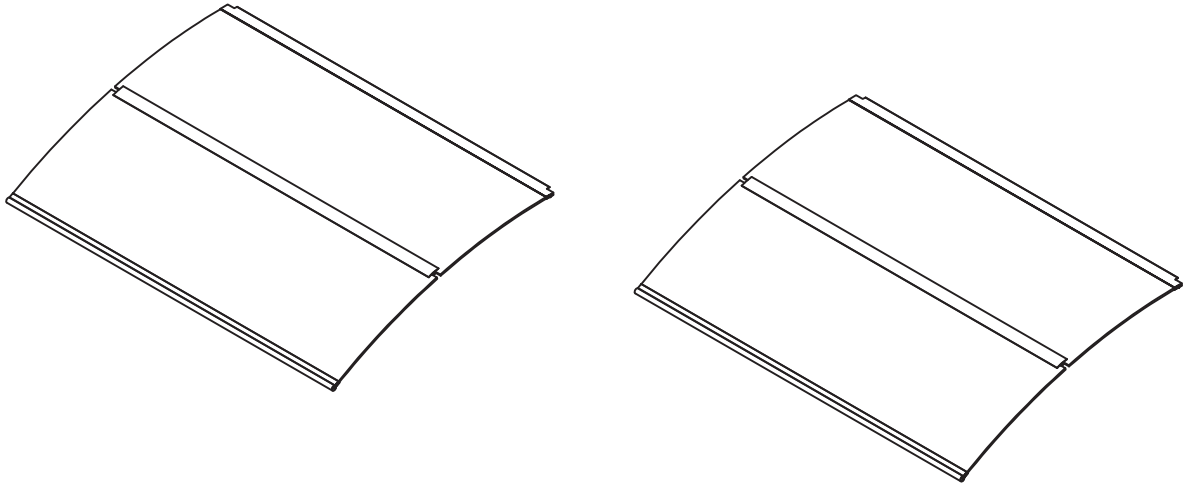

03

