

Ax2pcs

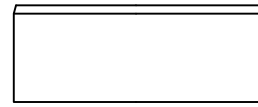

Bx2pcs

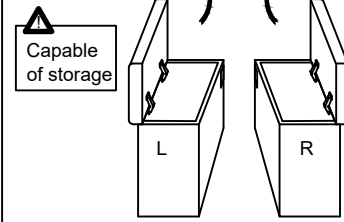

Step 1

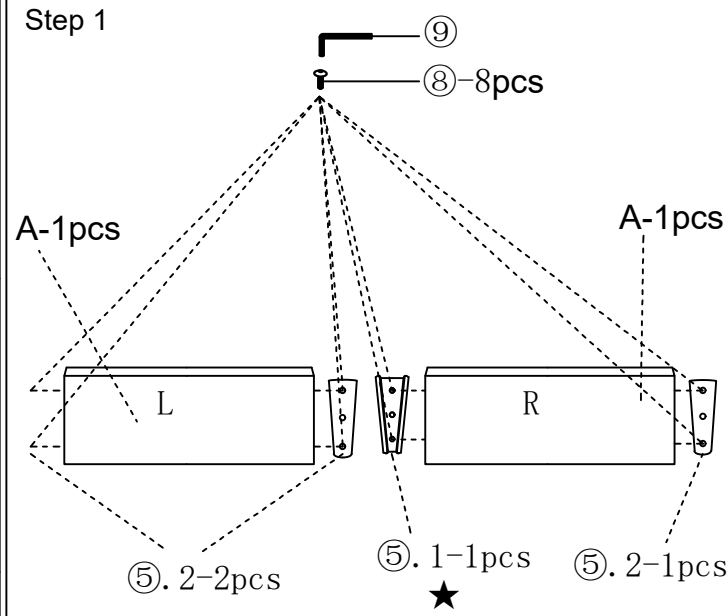

Step 2

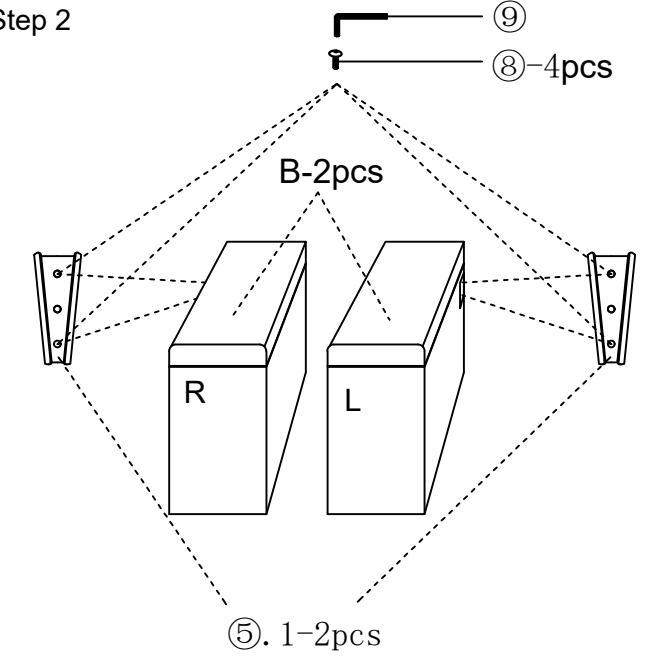

Cx8pcs



Dx2pcs



Ex4pcs

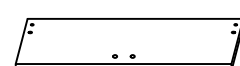

Fx2pcs

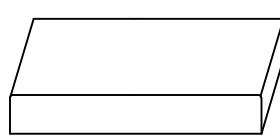

Step 3

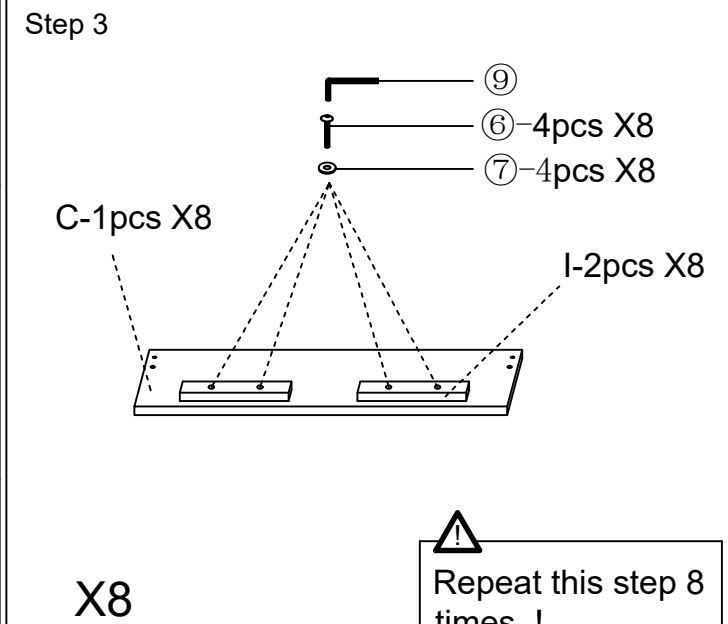

Step 4

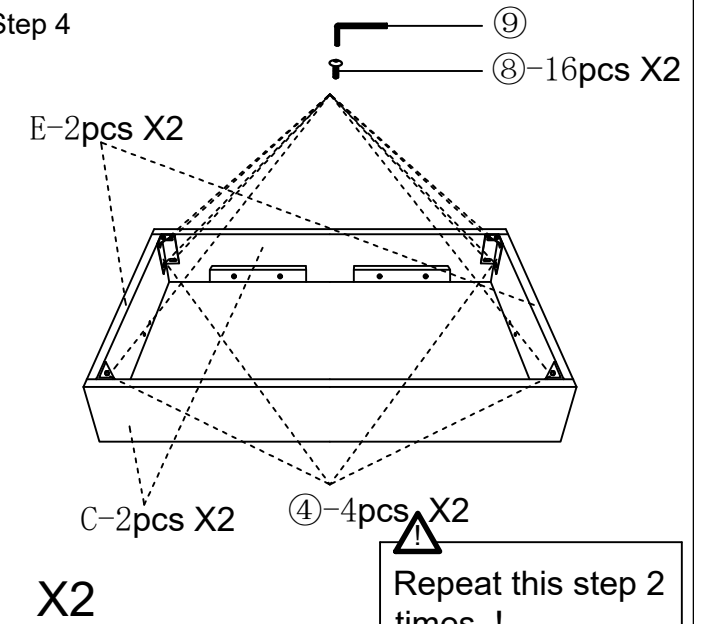

Gx2pcs

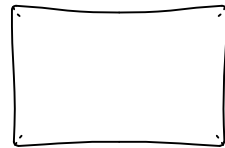

Hx2pcs

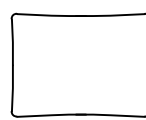

Ix16pcs

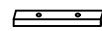

Jx4pcs

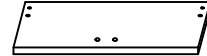

Step 5

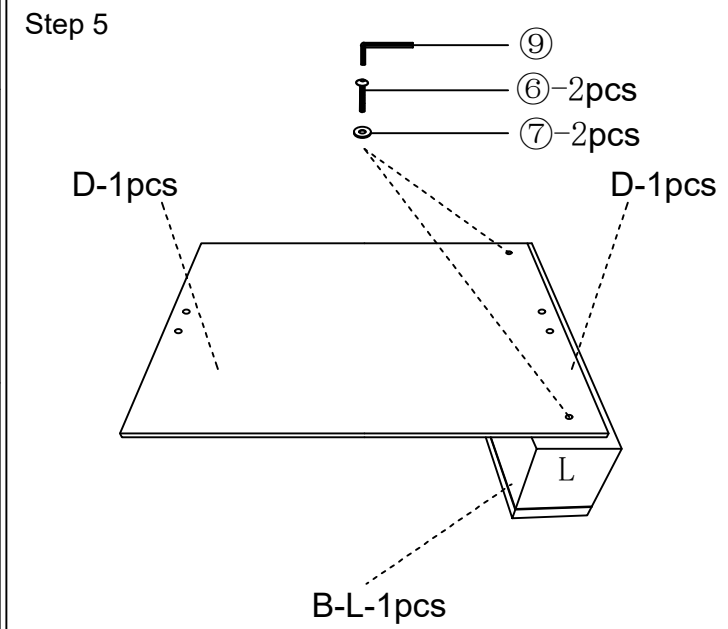

Step 6

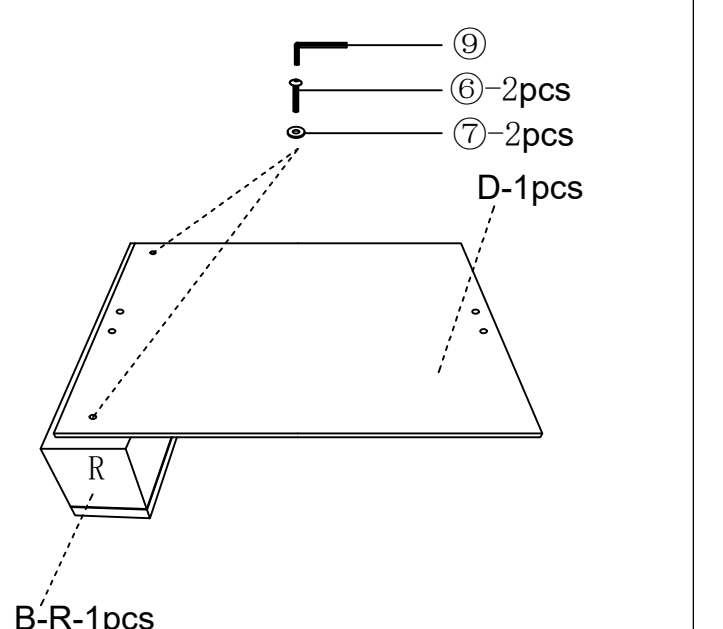

Kx2pcs

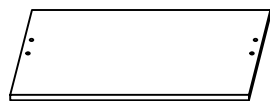

Lx2pcs

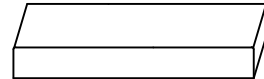

①x16pcs

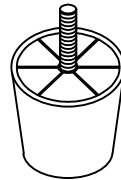

②x16pcs

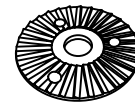

③x8pcs



④x16pcs



⑤. 1x3pcs

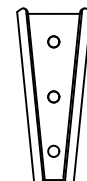

⑤. 2x3pcs



⑥x36pcs
M6*40mm

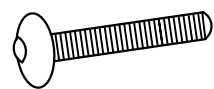

⑦x36pcs
M6*22mm

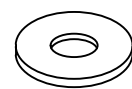

⑧x108pcs
M6*18mm

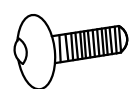

⑨x1pcs
M5



