

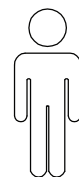

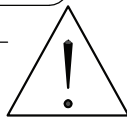

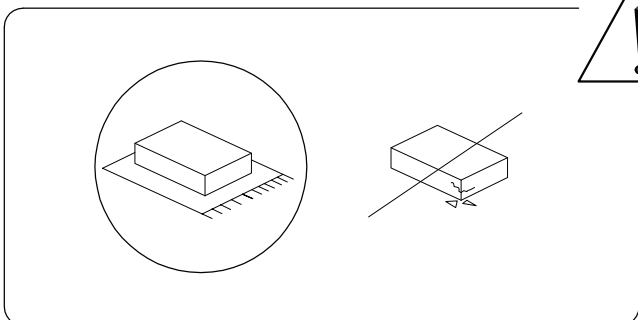





20'

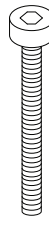
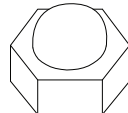
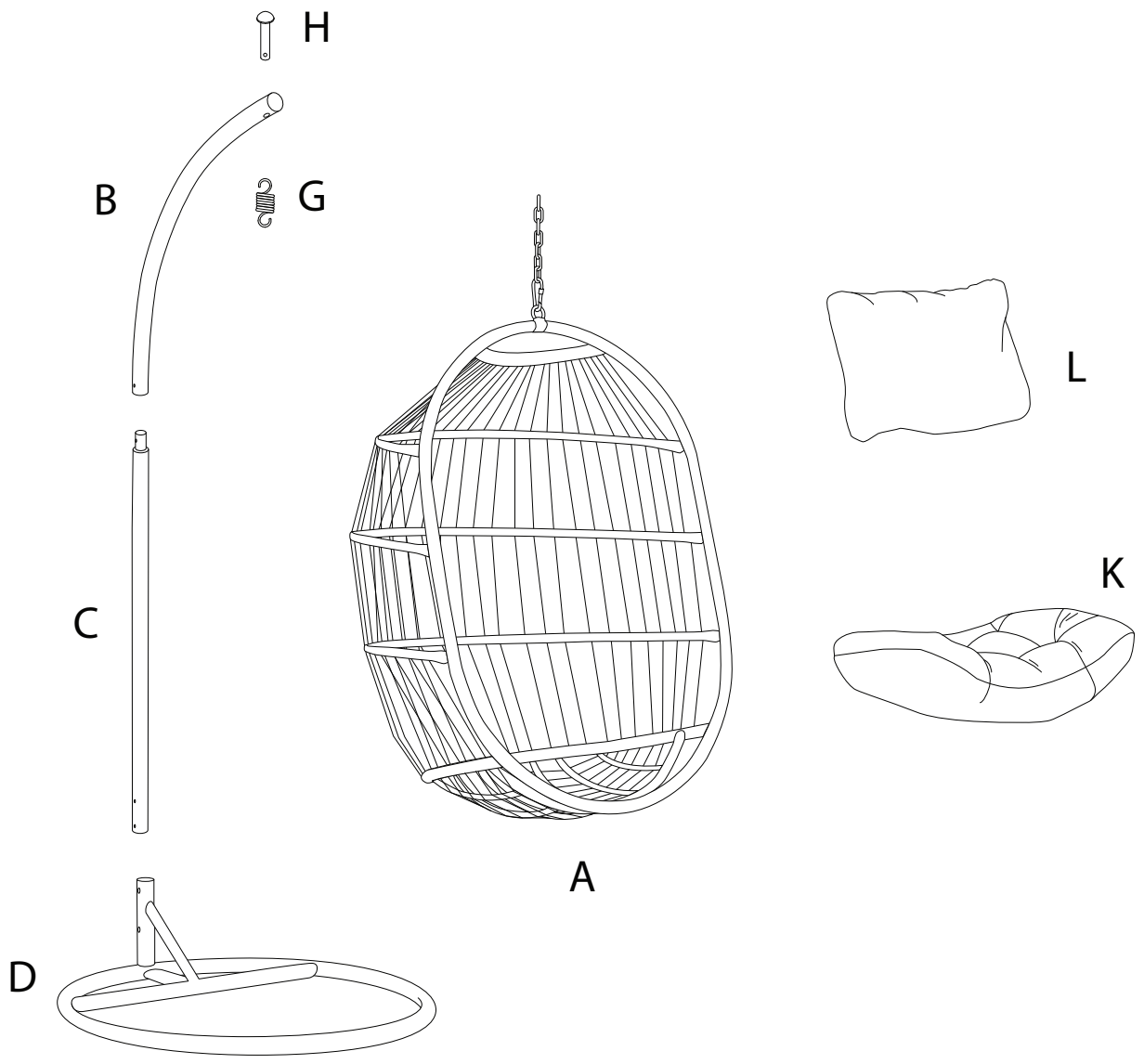

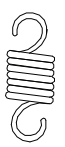
2

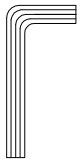
<b>A</b>  <b>x 1</b>	<b>B</b>  <b>x 1</b>	<b>C</b>  <b>x 1</b>	<b>D</b>  <b>x 1</b>	<b>E</b>  M10 x 60 <b>x 3</b>	<b>F</b>  <b>x 3</b>
---	---	---	--	---	---



<b>G</b>  <b>x 1</b>	<b>H</b>  <b>x 1</b>	<b>I</b>  <b>x 1</b>	<b>J</b>  <b>x 1</b>	<b>K</b>  <b>x 1</b>	<b>L</b>  <b>x 1</b>
---	---	---	---	---	---

1

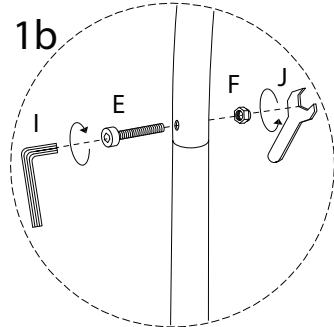
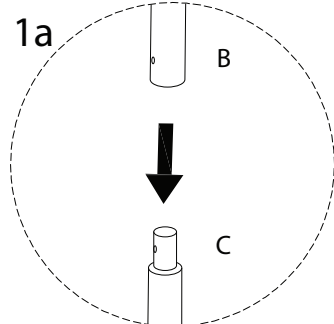
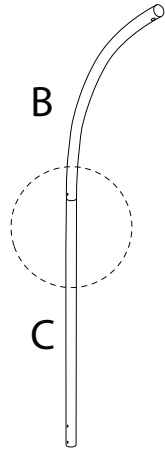
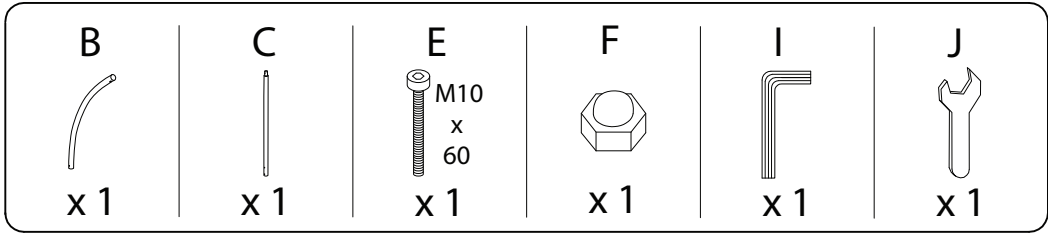

2

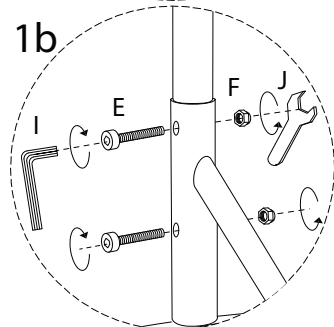
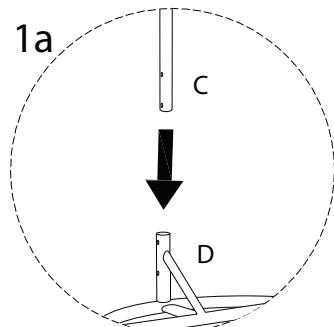
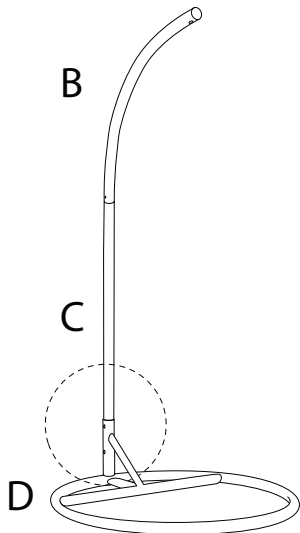
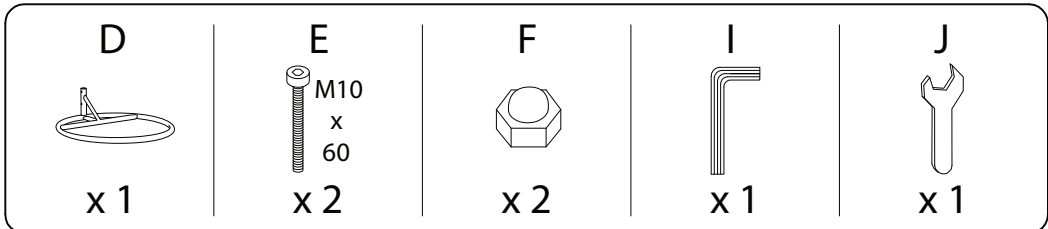

3

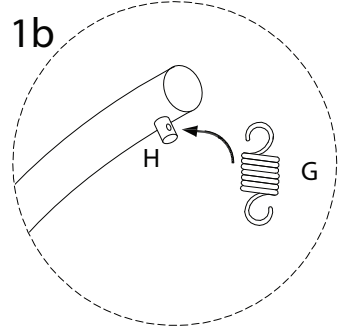
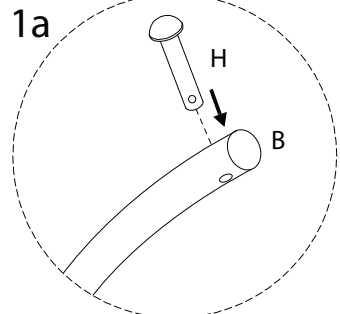
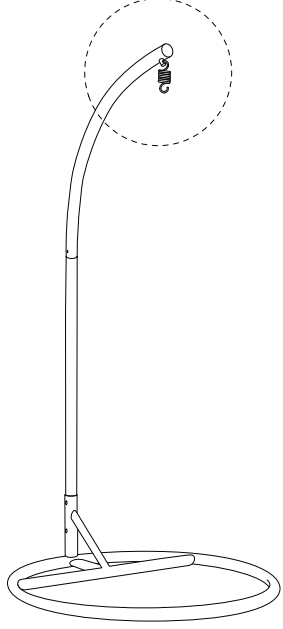
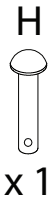

4

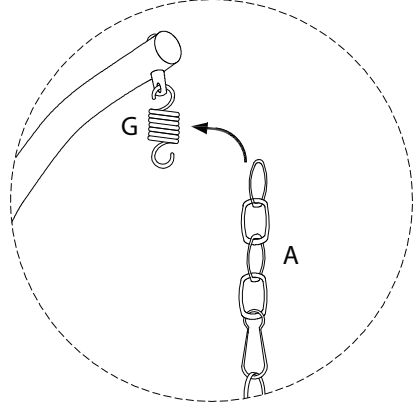
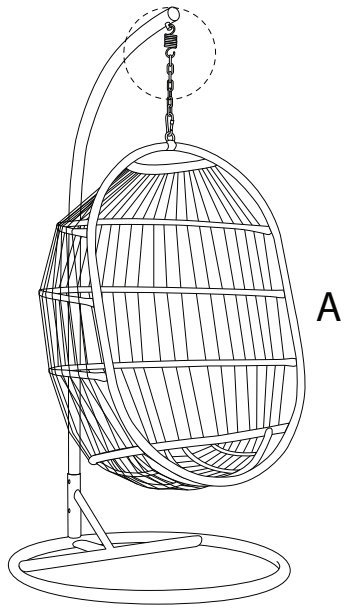

5

K



x 1

L



x 1

