

ASSEMBLY INSTRUCTION

Friendly Reminder:

- 1.This sofa is packed in 5 boxes. Please assemble it After all boxes are received.
- 2.As the cushions are all vacuum compressed,there will be some wrinkles. Please give your cushions up to 72 hours to reach its original size and the wrinkles will basically dissapper.
- 3.Please do not open the compressed packages until your sofa frame is completely assembler

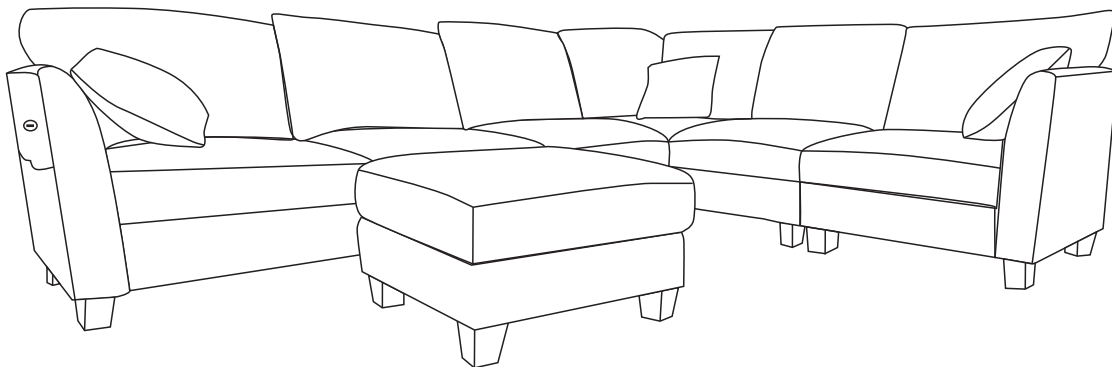

Return & Warranty policy:

- We strive to offer the highest quality products,and we also try our best to satisfy each and every customer that orders from us with replacement parts or service as needed.
- If the item is damaged or defective, please take photos as evidence for replacements and refunds.
- Please do not return to store,contact the seller if you have any troubles with this product.

All parts and hardwares

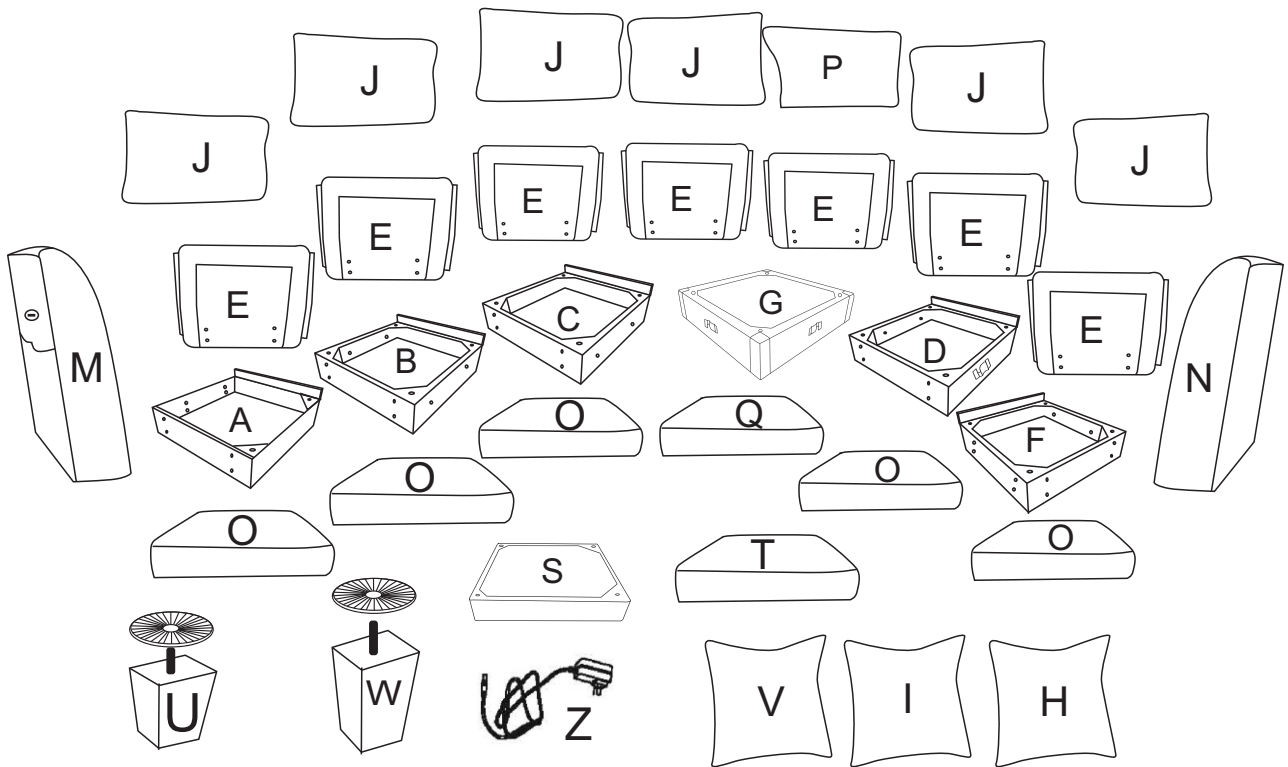

Hardware Package

BOX 1

- | | | | |
|----|---|----------------------|-------|
| 1. |  | Screws M8x35mm | 36pcs |
| 2. |  | Screws M8x50mm | 6pcs |
| 3. |  | nut M8 | 6pcs |
| 4. |  | Washer ϕ 8x22mm | 48pcs |
| 5. |  | Socket wrench | 1pcs |
| 6. |  | Wrench | 1pcs |

NOTE: Take out of all parts from 5 boxes, make sure all parts you have received before assembled.

COMPONENTS

BOX 1

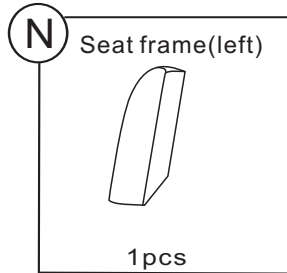
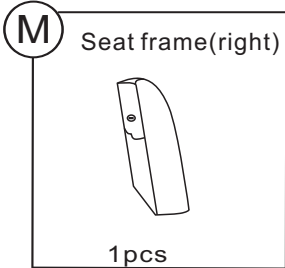

BOX 2

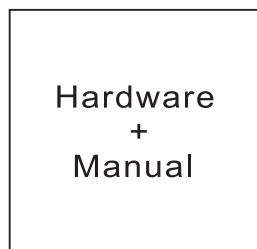
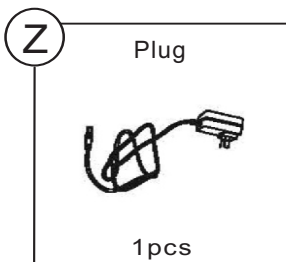
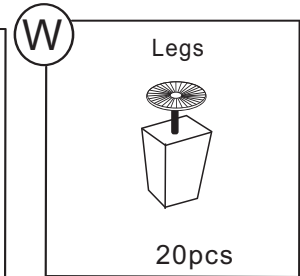
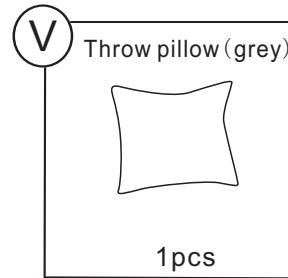
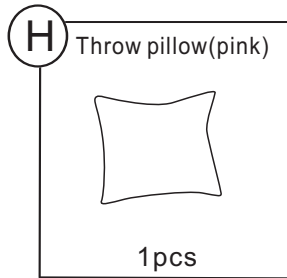
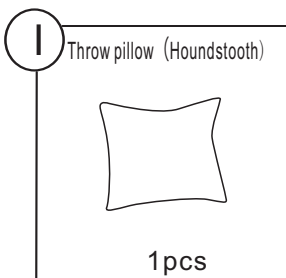
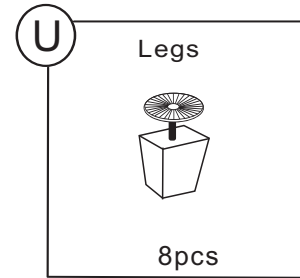
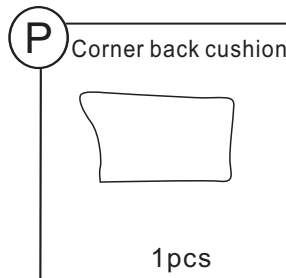
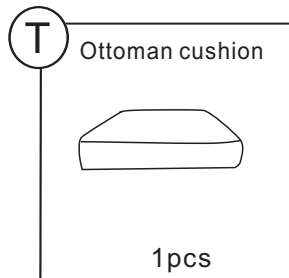
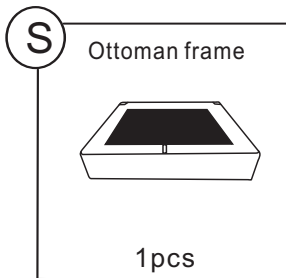

COMPONENTS

BOX 3

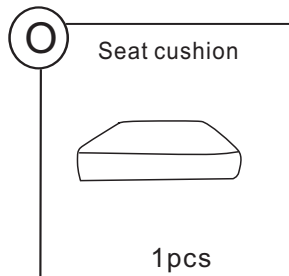
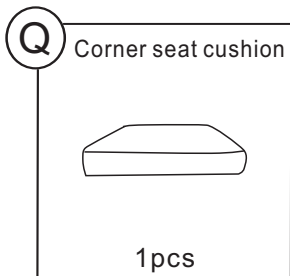
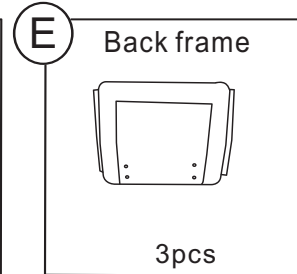
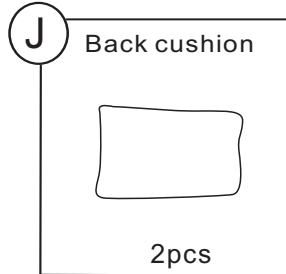
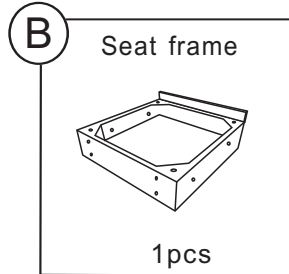
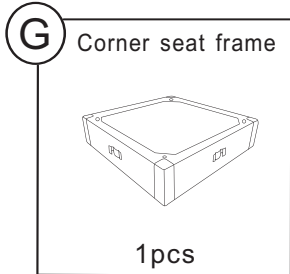

BOX 4

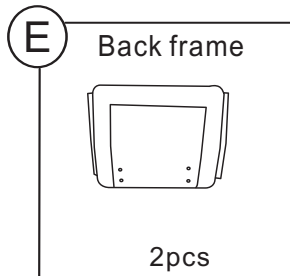
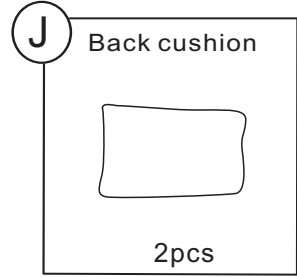
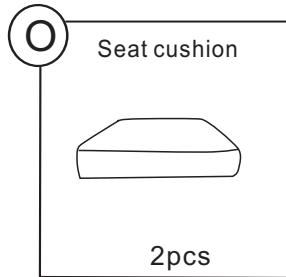
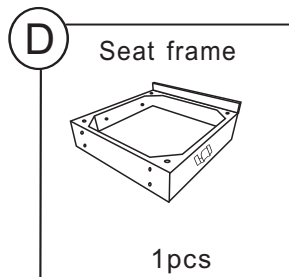
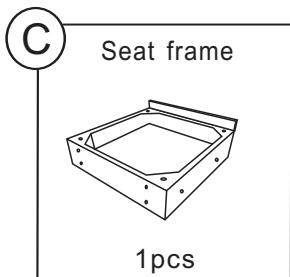

COMPONENTS

BOX 5

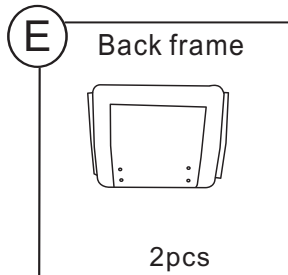
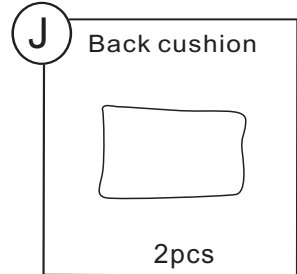
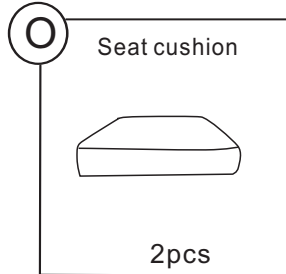
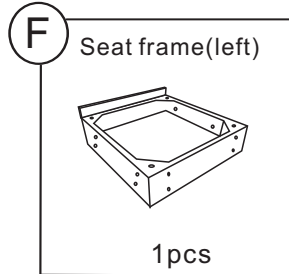
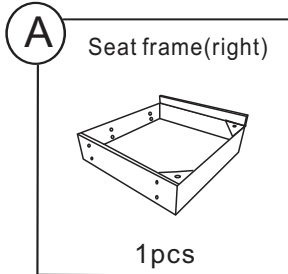







DIAGRAM 1 (Install the Armrest frame and assemble Seat frames)
 Connect the Armrest(Part M) to the Seat frame(Part A) with the Screws
 M8X35mm(Hardware 1)and the Washers (Hardware 4) by Wrench (Hardware 6).
 Combination the Seat frames(A&B&C)with the Bolts M8X50mm (Parts2) ,
 the Washer (Parts4) ,the nuts(Parts 3)by Socket wrench (Parts 5)and Wrench(Parts 6).

1		4pcs
2		4pcs
3		4pcs
4		12pcs
5		1pcs
6		1pcs

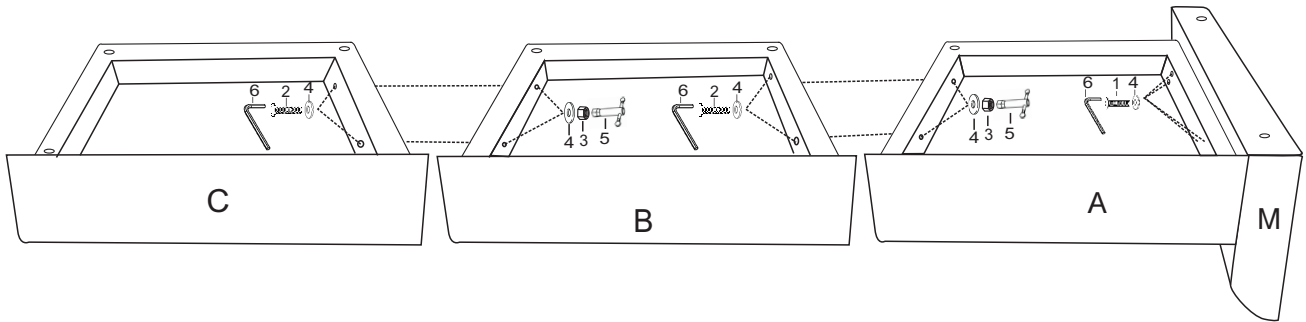

DIAGRAM 2(Assemble the Legs)
 Assemble the Seat frames (Part A&B&C)Legs(Part W),and the Armrest (Part M) Legs(Part U).

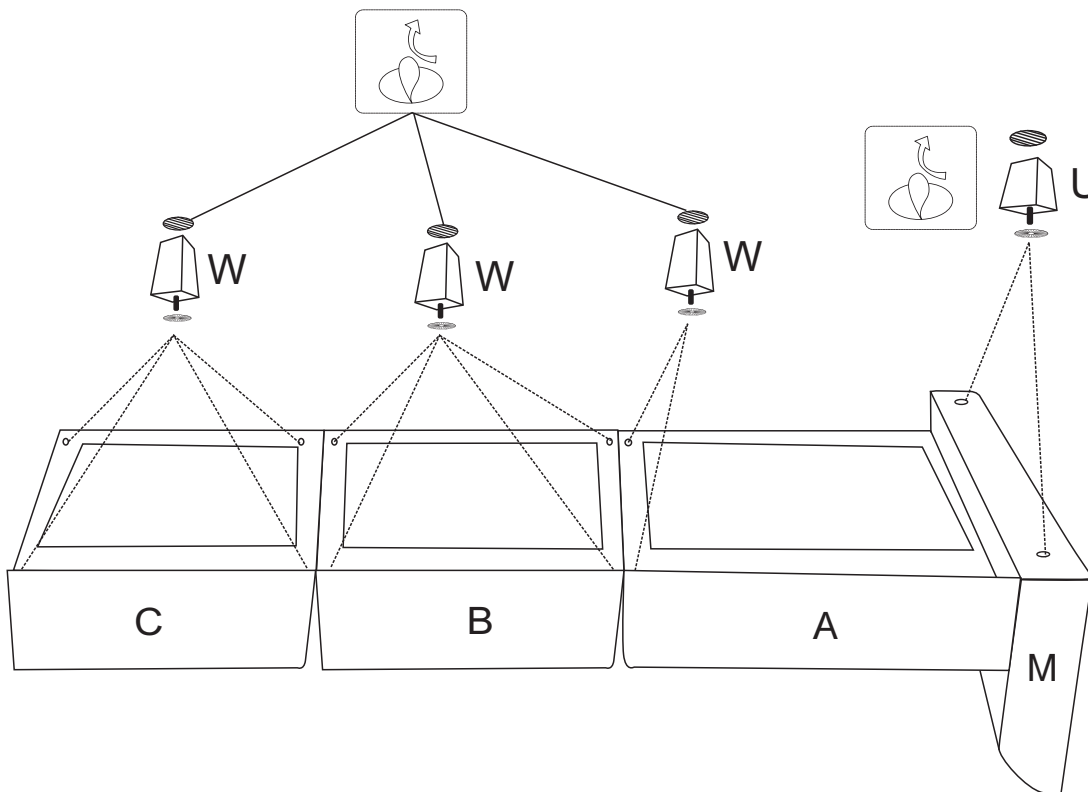





DIAGRAM 3 (Assemble the Back frames)1

Connect the Back frames (Part E) to Seat frames(Part A&B&C) with Screws M8x35mm(Hardware1)and Washers (Hardware 4) by Wrench(Hardware6) as shown. Then put Velcro pieces together. Please install the top Screws first, then the bottom Screws.Make sure all the Screws are in the holes before tightening them.

1		12pcs
4		12pcs
6		1pcs

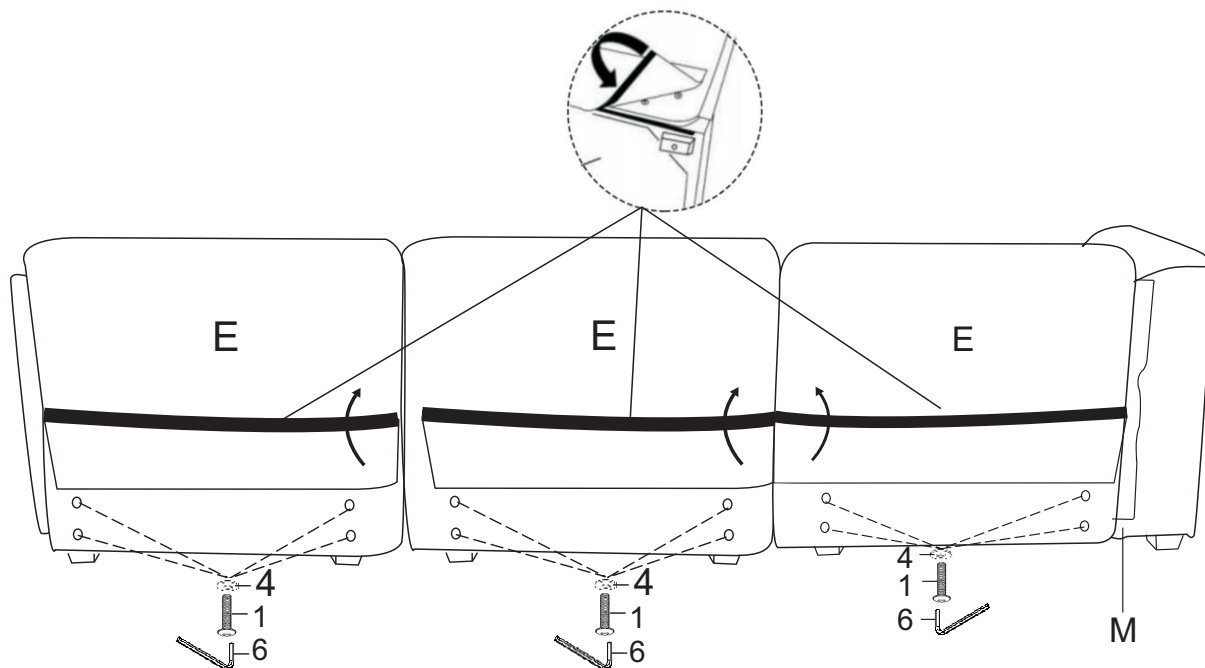







DIAGRAM 4 (Install the Armrest frame and assemble Seat frames)

Connect the Armrest(Part N) to the Seat frame(Part F) with the Screws M8X35mm(Hardware 1)and the Washers (Hardware 4) by Wrench (Hardware 6). Combination the Seat frames(D&F)with the Bolts M8X50mm (Parts2) , the Washer (Parts4) ,the nuts(Parts 3)by Socket wrench (Parts 5)and Wrench(Parts 6).

1		4pcs
2		2pcs
3		2pcs
4		8pcs
5		1pcs
6		1pcs

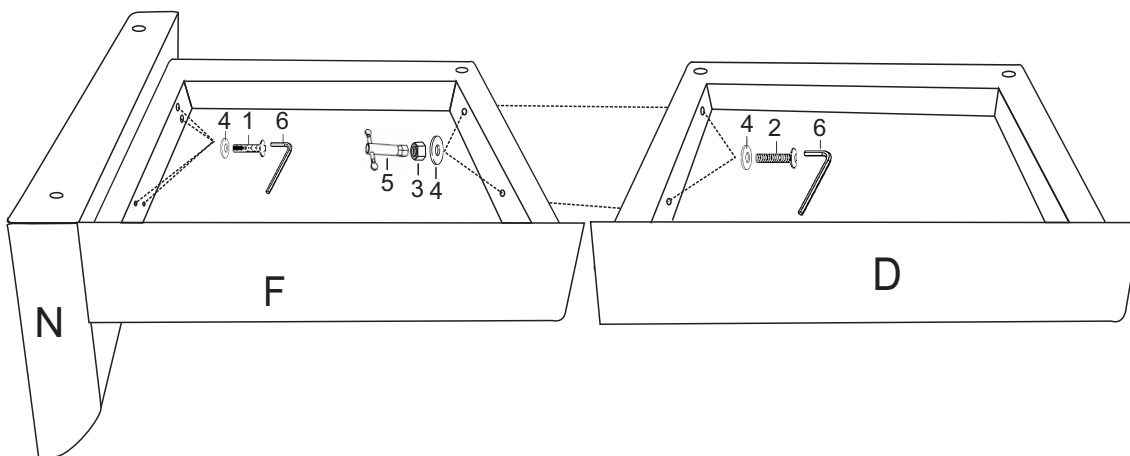

DIAGRAM 5(Assemble the Legs)

Assemble the Seat frames (Part D&F)Legs(Part W),and the Armrest (Part N) Legs(Part U).

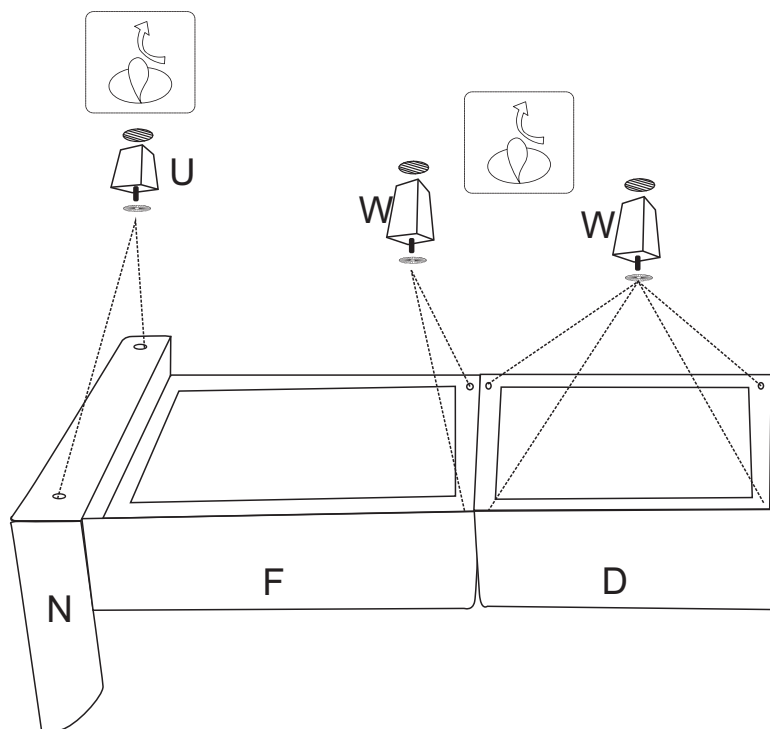





DIAGRAM 6 (Assemble the Back frames)1

Connect the Back frames (Part E) to Seat frames(Part D&F) with Screws M8x35mm(Hardware 1)and Washers (Hardware 4) by Wrench(Hardware6) as shown. Then put Velcro pieces together. Please install the top Screws first, then the bottom Screws. Make sure all the Screws are in the holes before tightening them.

1		8pcs
4		8pcs
6		1pcs

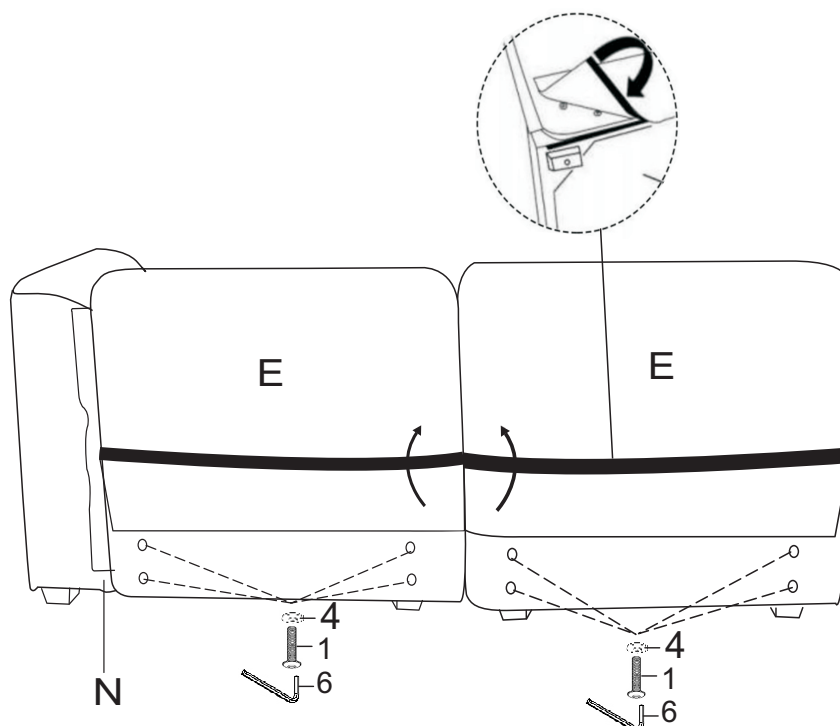

DIAGRAM 7(Assemble the Legs)

Assemble the Corner seat frame (Part G)Legs(Part W),and the Ottoman frame (Part S) Legs(Part U).

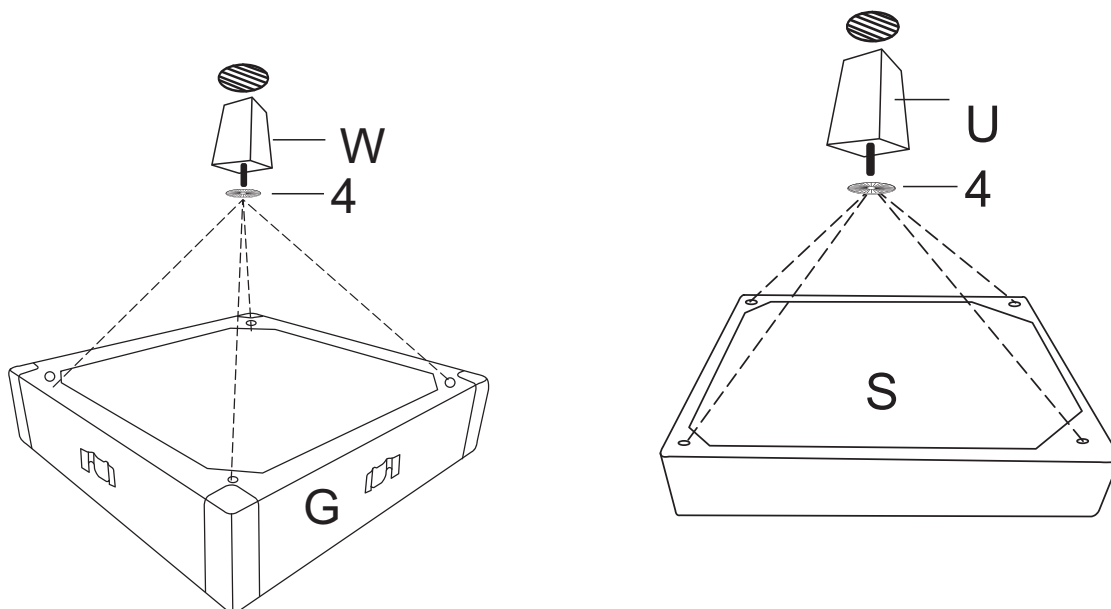





DIAGRAM 8 (Assemble the Back frames)1

Connect the Back frames (Part E)to the Corner seat frame (Part G)with Screws M8x35mm(Hardware 1)and Washers (Hardware 4) by Wrench(Hardware 6) as shown. Then put Velcro pieces together. Please install the top Screws first, then the bottom Screws. Make sure all the Screws are in the holes before tightening them.

1		8pcs
4		8pcs
6		1pcs

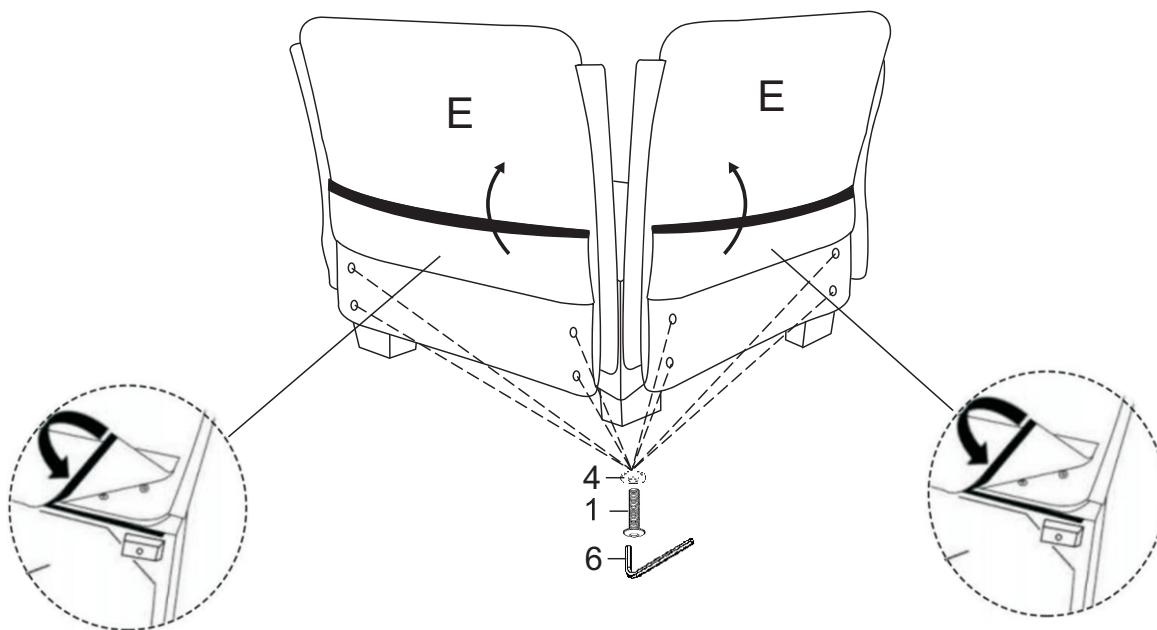

DIAGRAM 9(Assemble all the Seat frames)

Combine seat frames ABC&DF and Corner seat frame together through hanging pieces as shown.

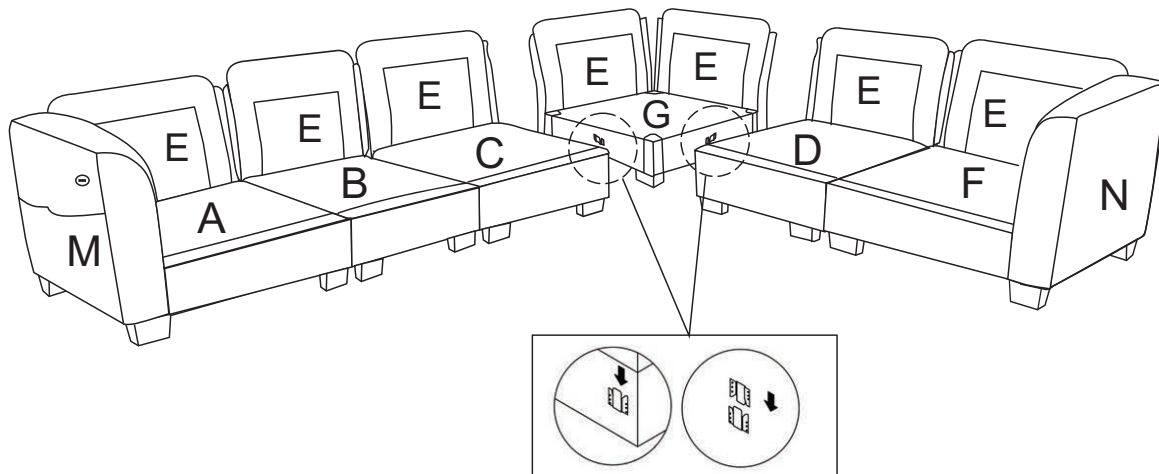

DIAGRAM 10 (Removal of compressed bags)

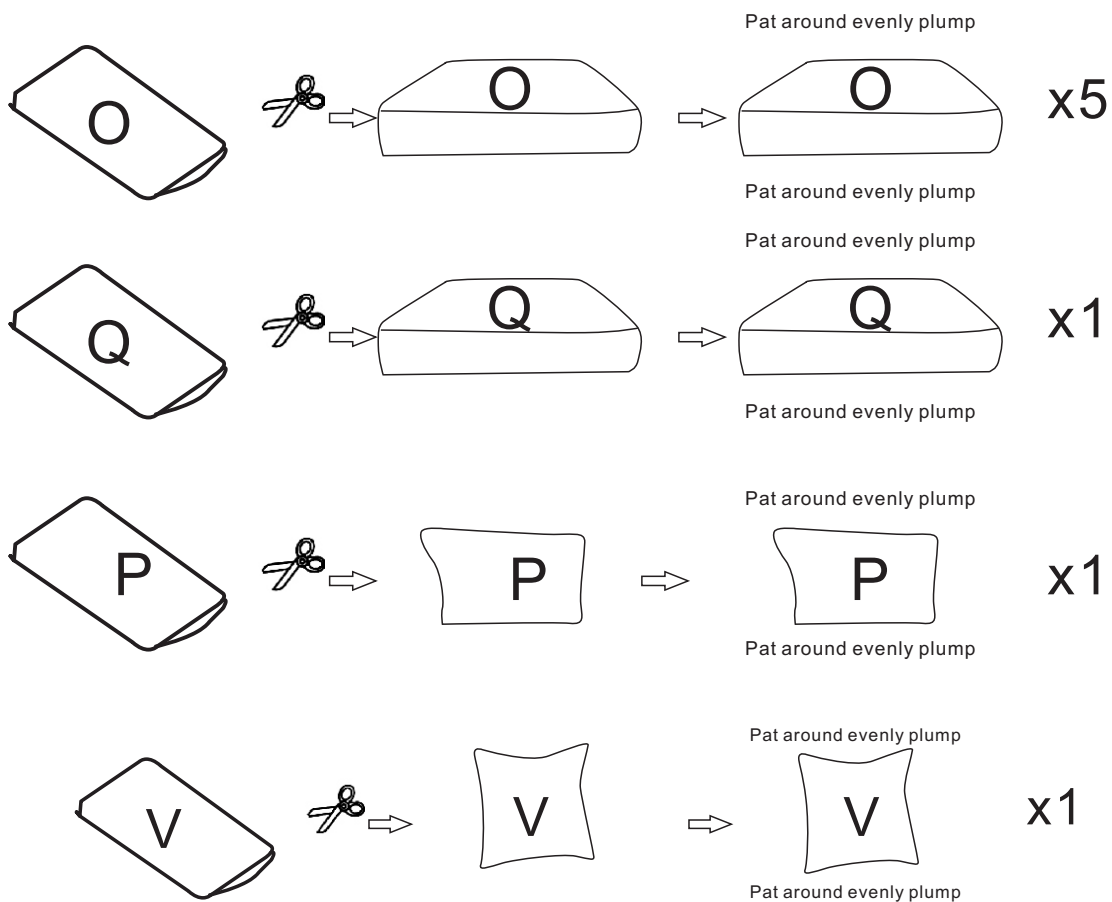
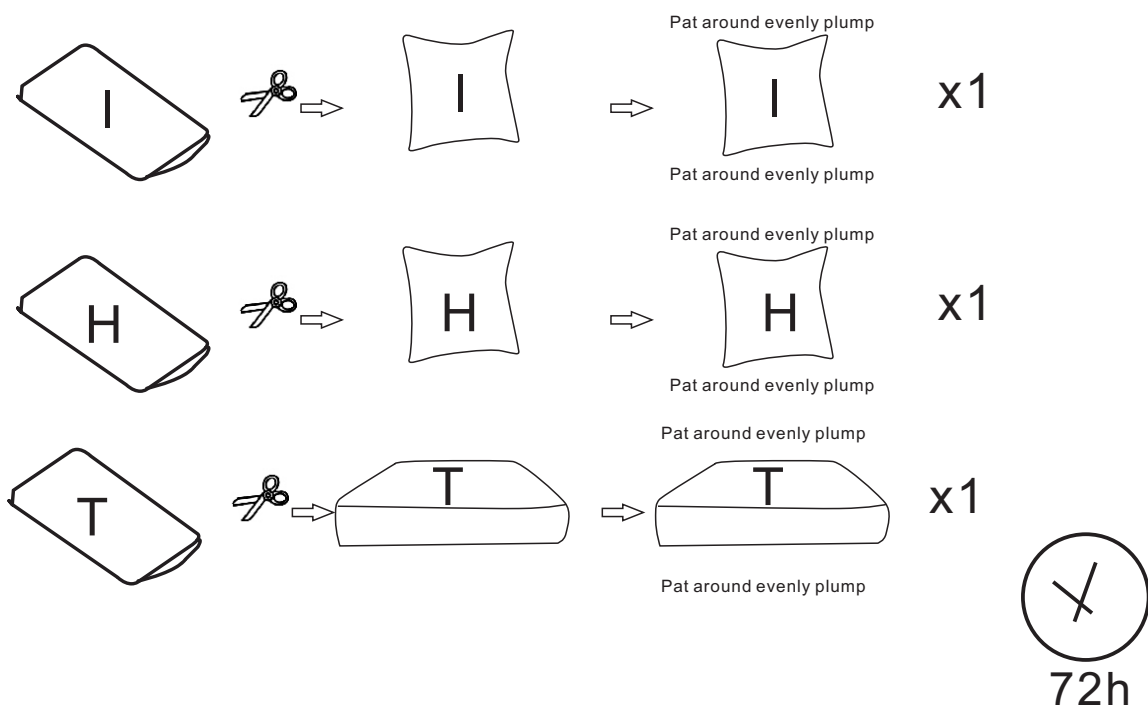

DIAGRAM 11 (Place cushions on the sofa)

Put the Seat frames(Part O&Q), the Back cushions (Part J&P) on the sofa.



TIPS:

1. Please do not open the compressed packages until your sofa frame is completely assembled.
2. Compressed cushions need to be fully fulfilled within 72 hours for your perfect use.
3. Please keep children away from plastic bags or any small pieces of stuff .

DIAGRAM 12 (Place cushion and pillows on the sofa)

Put the Ottoman cushion(Part T) and Throw pillows(Part H&I&V) on the sofa.
Recheck all the bolts before you sit on the sofa.

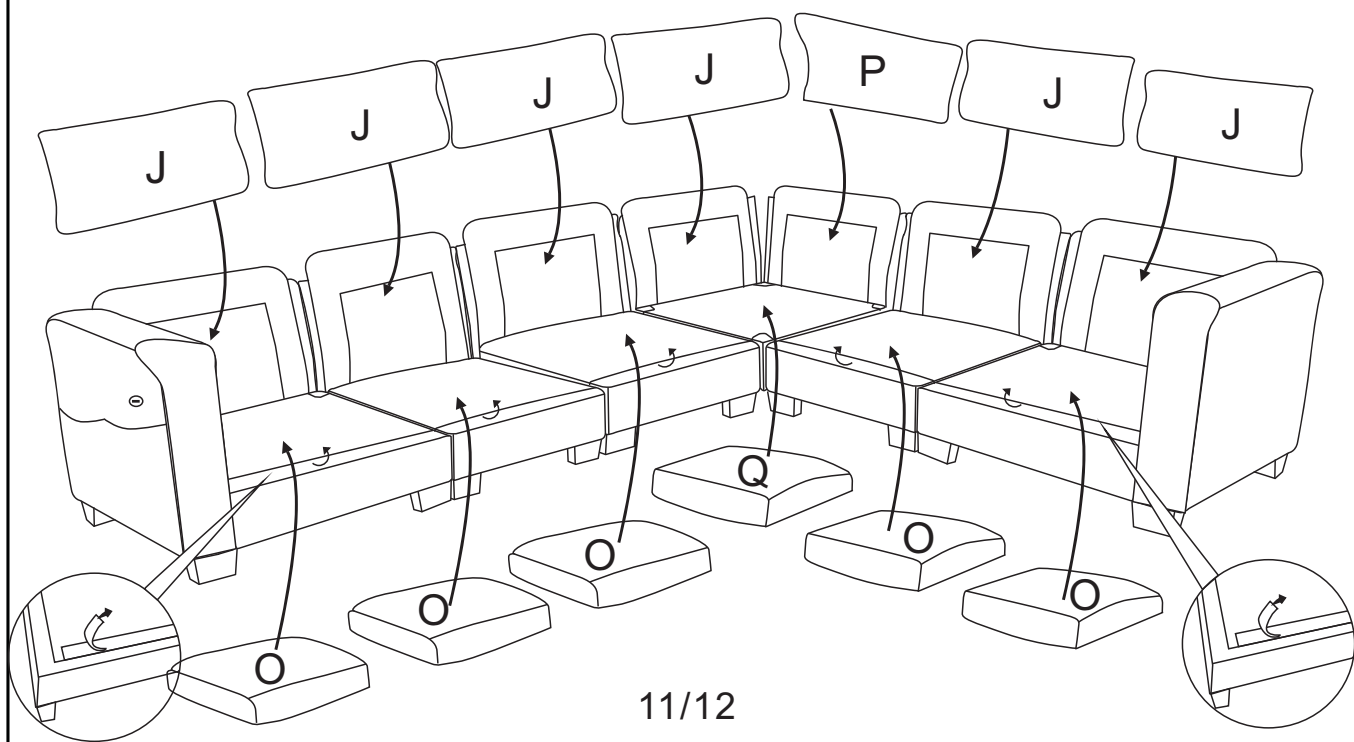
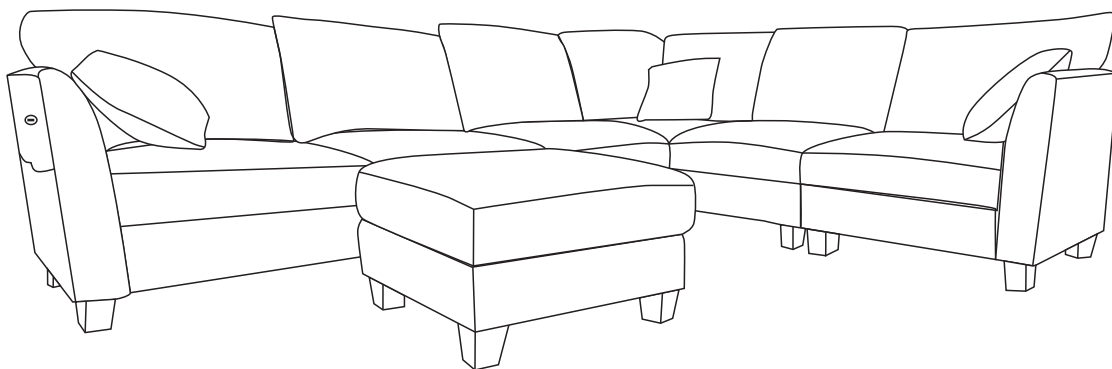
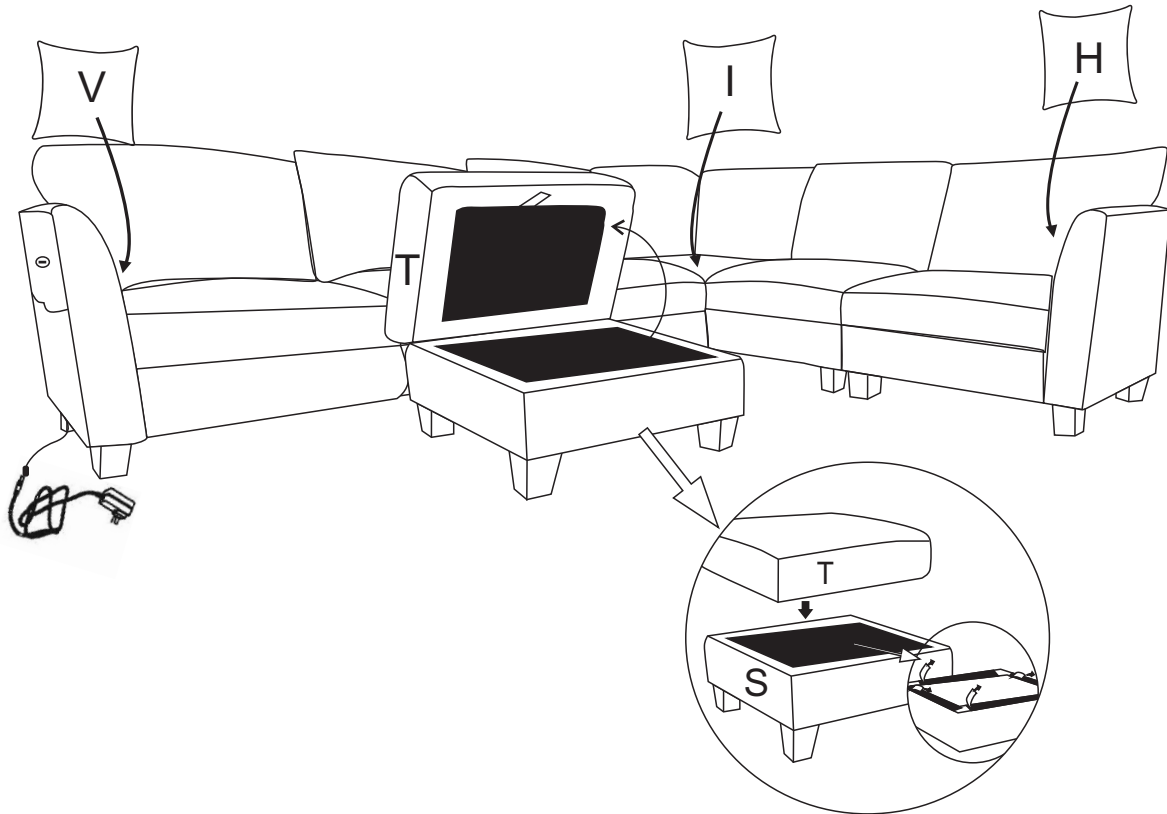

DIAGRAM 10 (Place cushion and pillows on the sofa)
Put the Ottoman cushion(Part T) and Throw pillows(Part H&F&V) on the sofa.
Recheck all the bolts before you sit on the sofa.



COMPLETE