

# ASSEMBLY INSTRUCTION

## NOTES:

Do not skip any step.

Do not fully tight screws until all the bed parts are assembled.









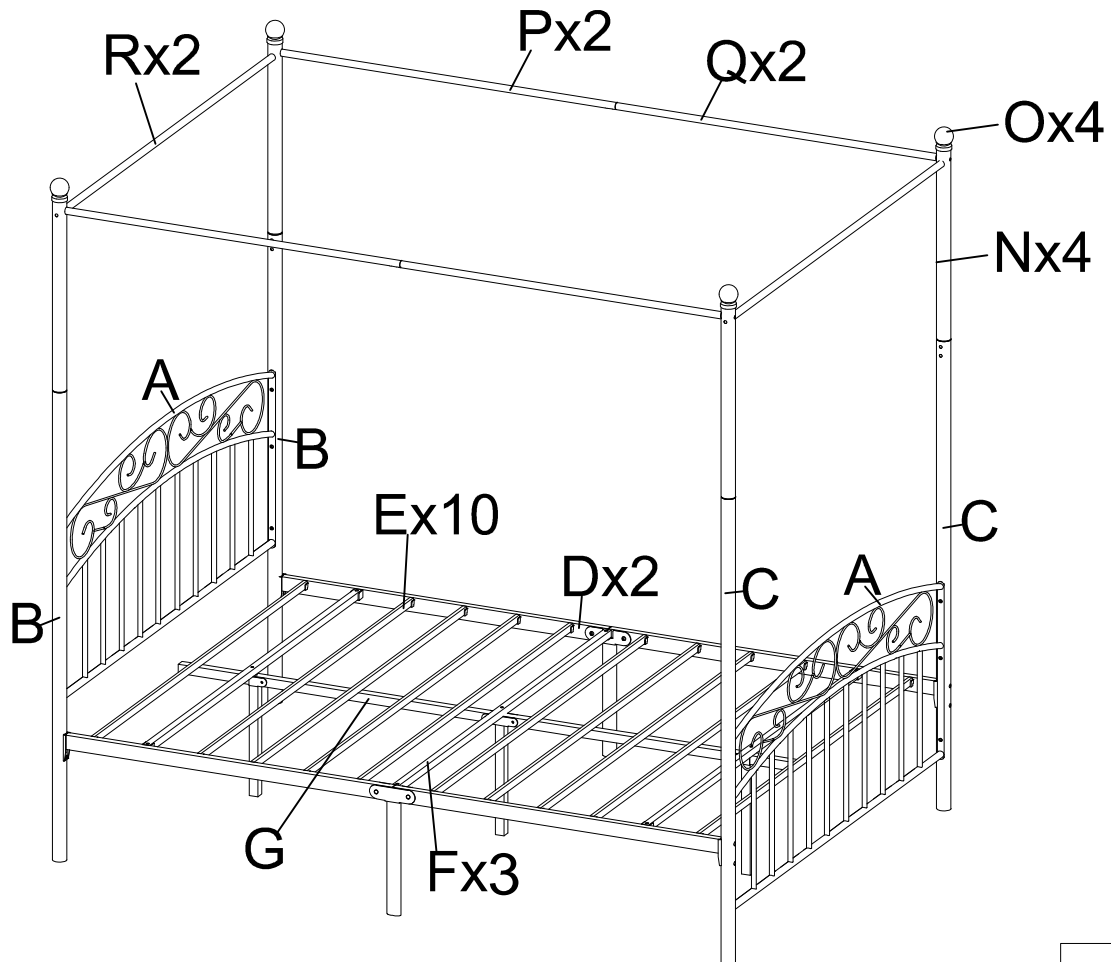

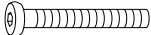
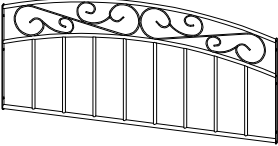
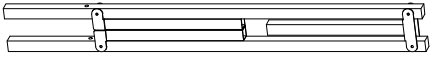

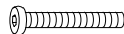
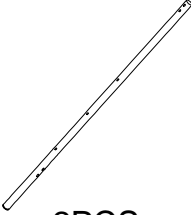



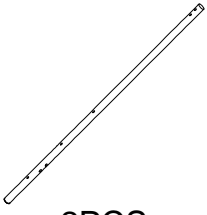
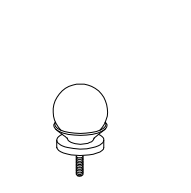

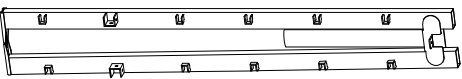
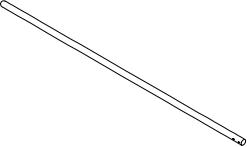
## WARNING:

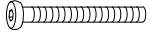
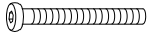
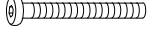
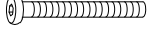

WARNIND FOR YOUNG CHILDREN-This product contains small components,please ensure that they are kept away from small children while assembling.

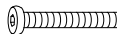
## Warranty Information:

We warranty this product to be free from defects in materials.This warranty covers one year from the date of original purchase.If u have an uer about bed ls contact our after -sale support email:



<p style="text-align: center;"><b>A</b></p>	<p style="text-align: center;"><b>G</b></p>	<p>aa</p>		<p>M8x55</p>	<p>4</p>							
 <p style="text-align: center;">2PCS</p>	 <p style="text-align: center;">1PC</p>	<p>bb</p>		<p>M6x55</p>	<p>11</p>							
<p style="text-align: center;"><b>B</b></p>	<p style="text-align: center;"><b>N</b></p>	<p>cc</p>		<p>M6x35</p>	<p>4</p>							
 <p style="text-align: center;">2PCS</p>	 <p style="text-align: center;">4PCS</p>	<p>dd</p>		<p>M6x30</p>	<p>6</p>							
<p style="text-align: center;"><b>C</b></p>	<p style="text-align: center;"><b>O</b></p>	<p>ee</p>		<p>M6x12</p>	<p>24</p>							
 <p style="text-align: center;">2PCS</p>	 <p style="text-align: center;">4PCS</p>	<p>ff</p>			<p>16</p>							
<p style="text-align: center;"><b>D</b></p>	<p style="text-align: center;"><b>P</b></p>	<p>gg</p>			<p>4</p>							
 <p style="text-align: center;">2PCS</p>	 <p style="text-align: center;">2PCS</p>	<p>hh</p>			<p>2</p>							
<p style="text-align: center;"><b>E</b></p>	<p style="text-align: center;"><b>Q</b></p>	<p style="text-align: center;">SPARE</p>										
 <p style="text-align: center;">10PCS</p>	 <p style="text-align: center;">2PCS</p>					<p>ii</p>			<p>1</p>			
<p style="text-align: center;"><b>F</b></p>	<p style="text-align: center;"><b>R</b></p>											
 <p style="text-align: center;">3PCS</p>	 <p style="text-align: center;">2PCS</p>								<p>aa</p>			<p>1</p>
									<p>bb</p>			<p>1</p>
									<p>cc</p>			<p>1</p>
									<p>dd</p>			<p>1</p>
		<p>ee</p>			<p>1</p>							
		<p>ff</p>			<p>1</p>							
<p>gg</p>			<p>1</p>									
			<p style="text-align: center; font-size: 2em;">2/7</p>									



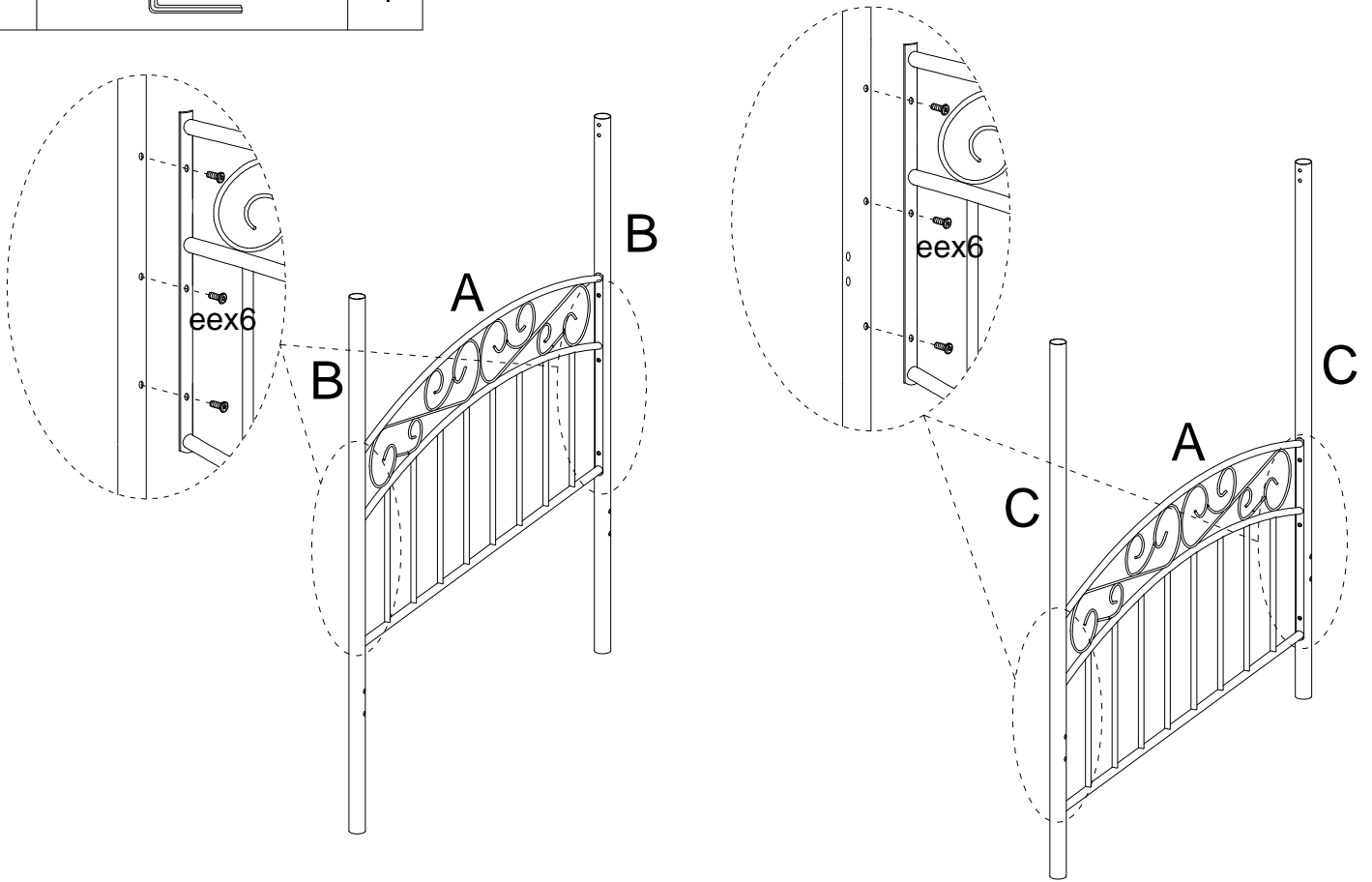

ee		M6x12	12
hh			1

Step 1

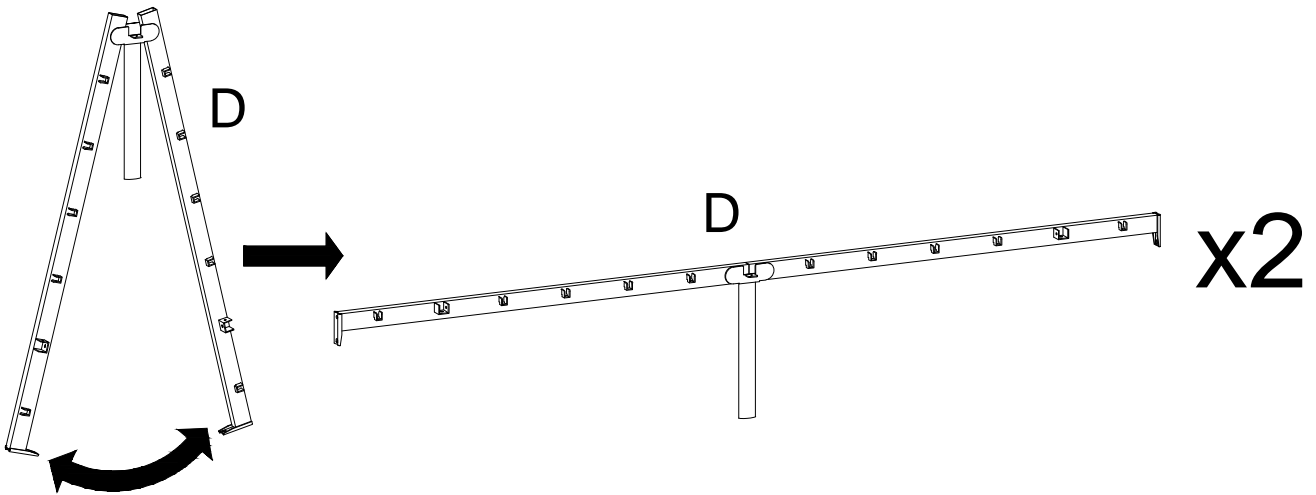

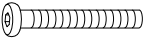

Step 2

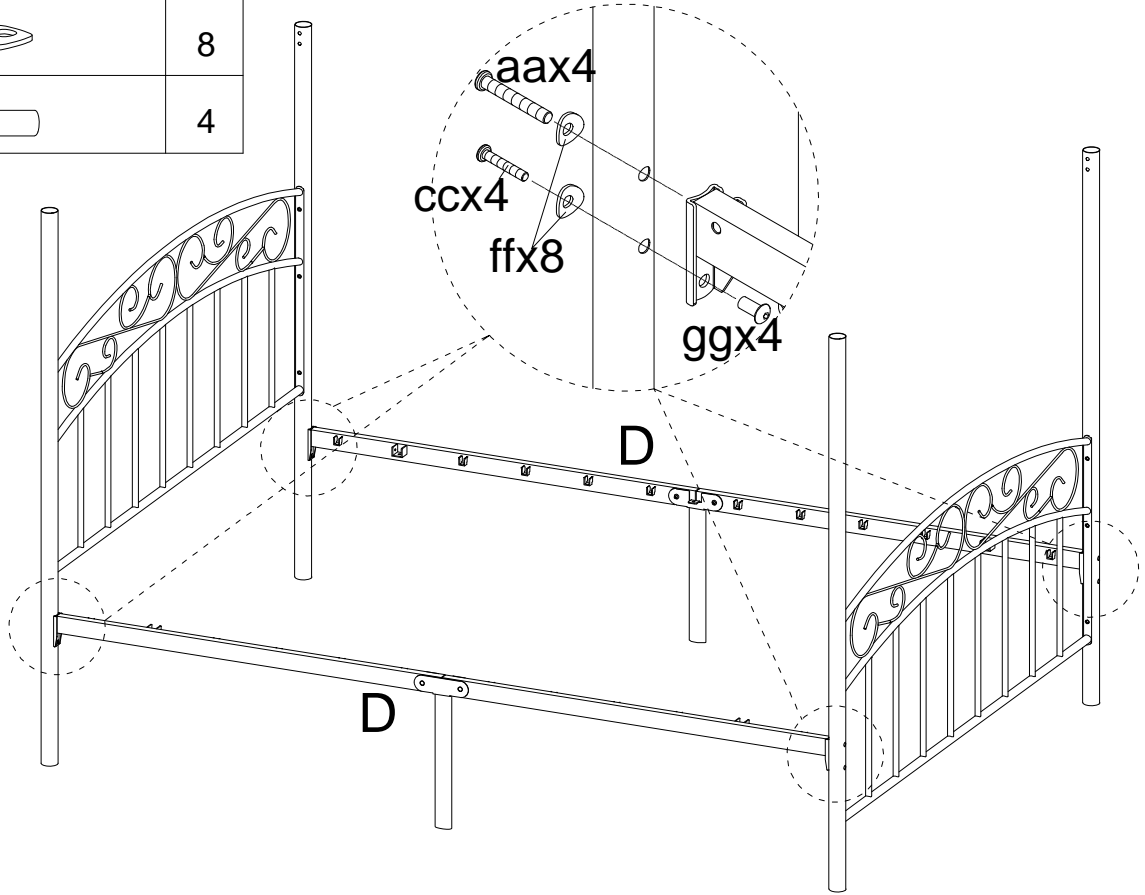

aa		M8x55	4	hh		2
cc		M6x35	4			
ff			8			
gg			4			

Step 3

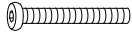

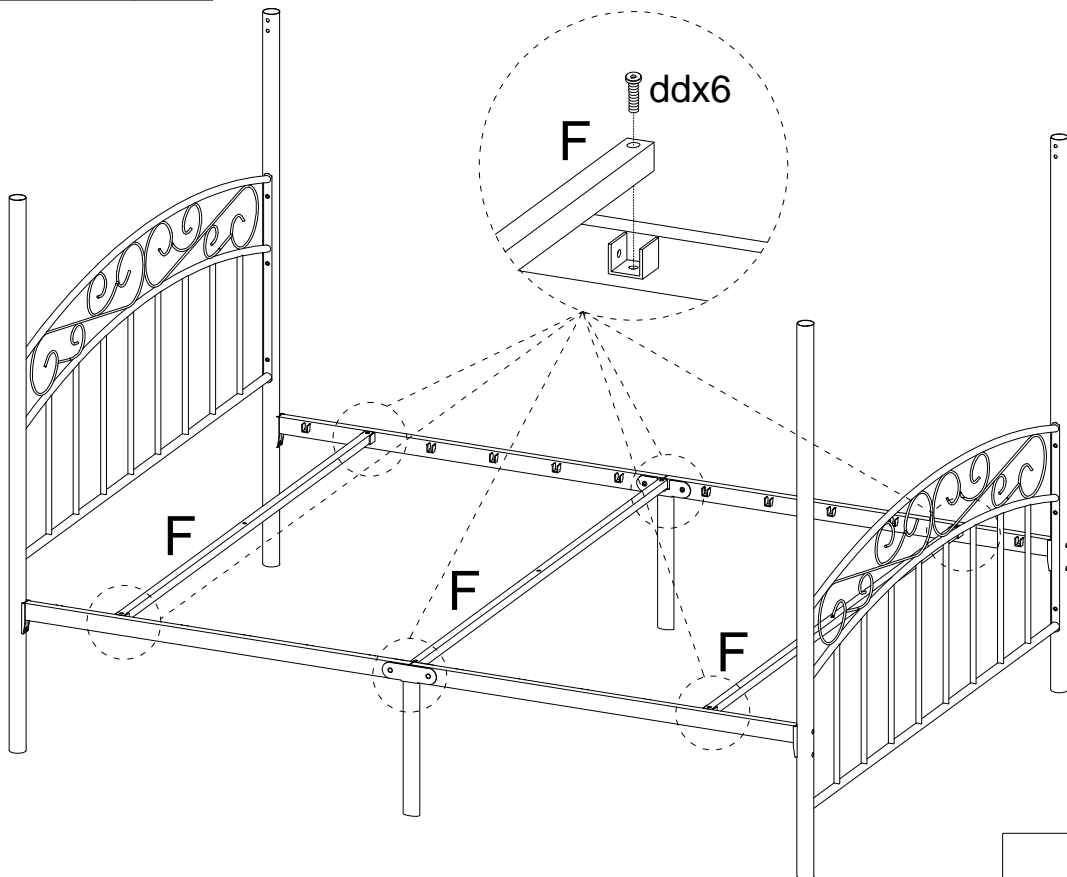

dd		M6x30	6			
hh			1			

Step 4

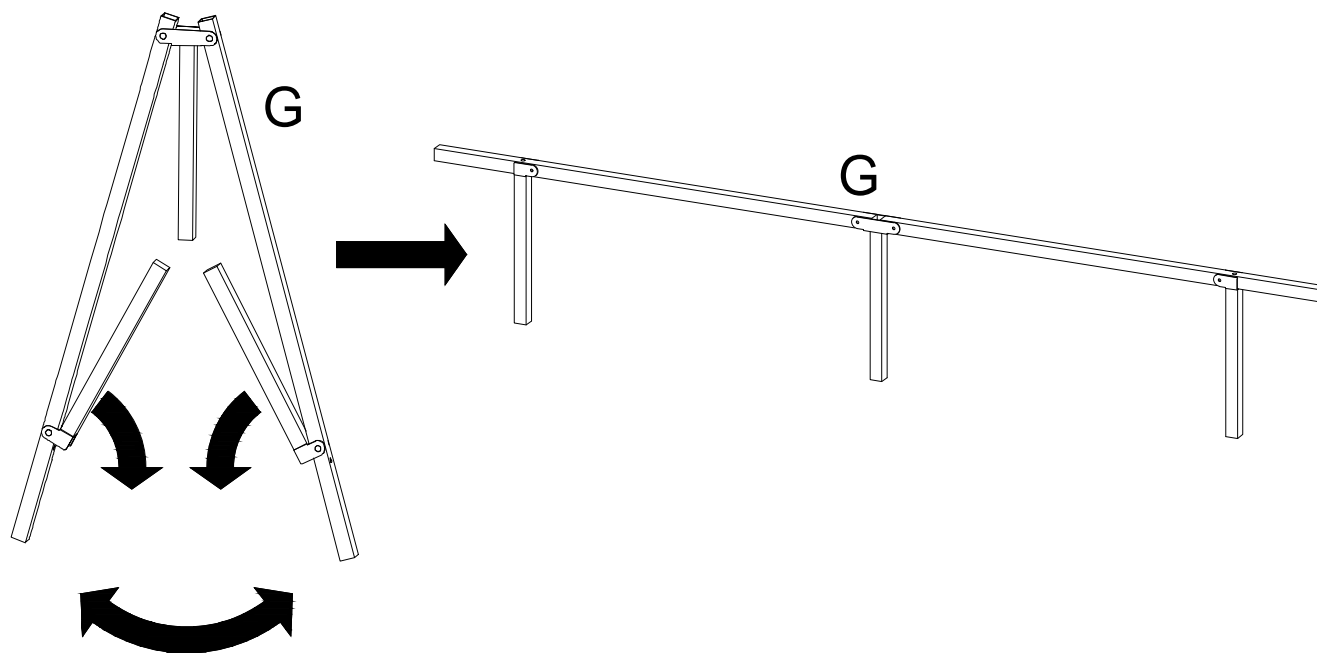



bb		M6x55	3
hh			1
ii			1

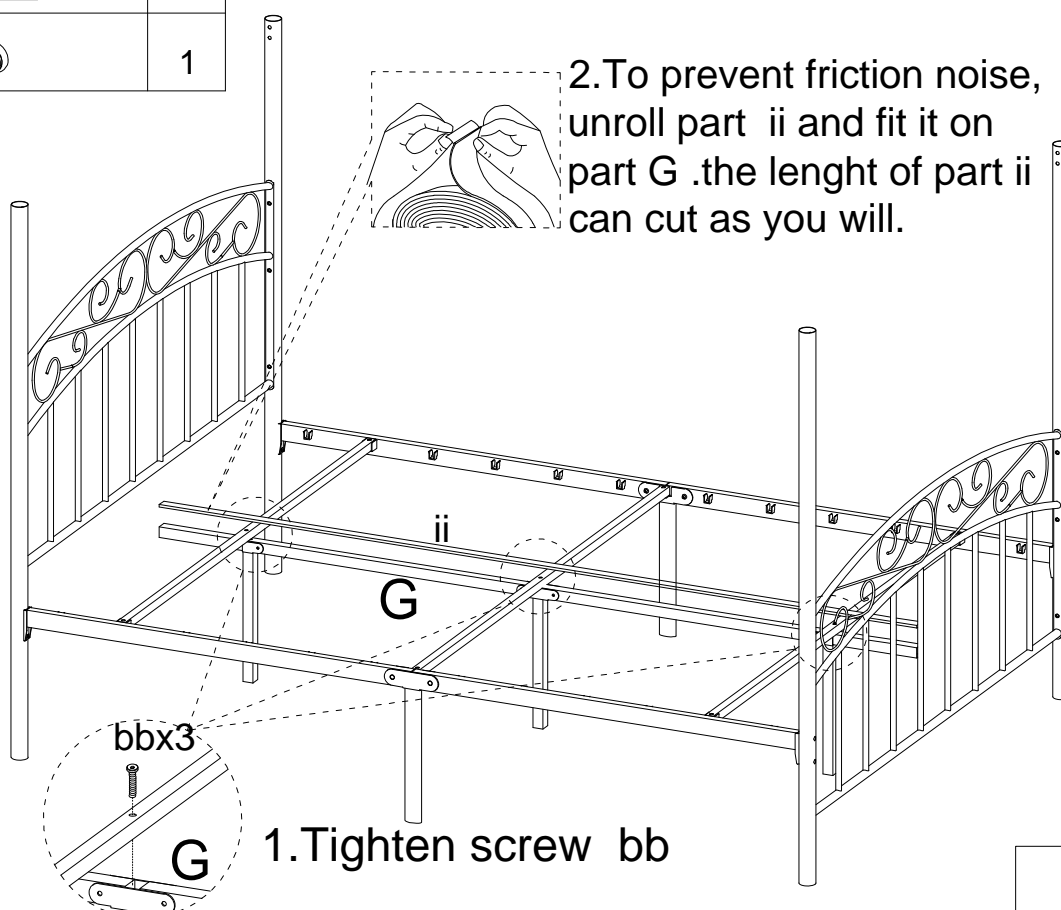



2. To prevent friction noise, unroll part ii and fit it on part G. the length of part ii can cut as you will.

1. Tighten screw bb

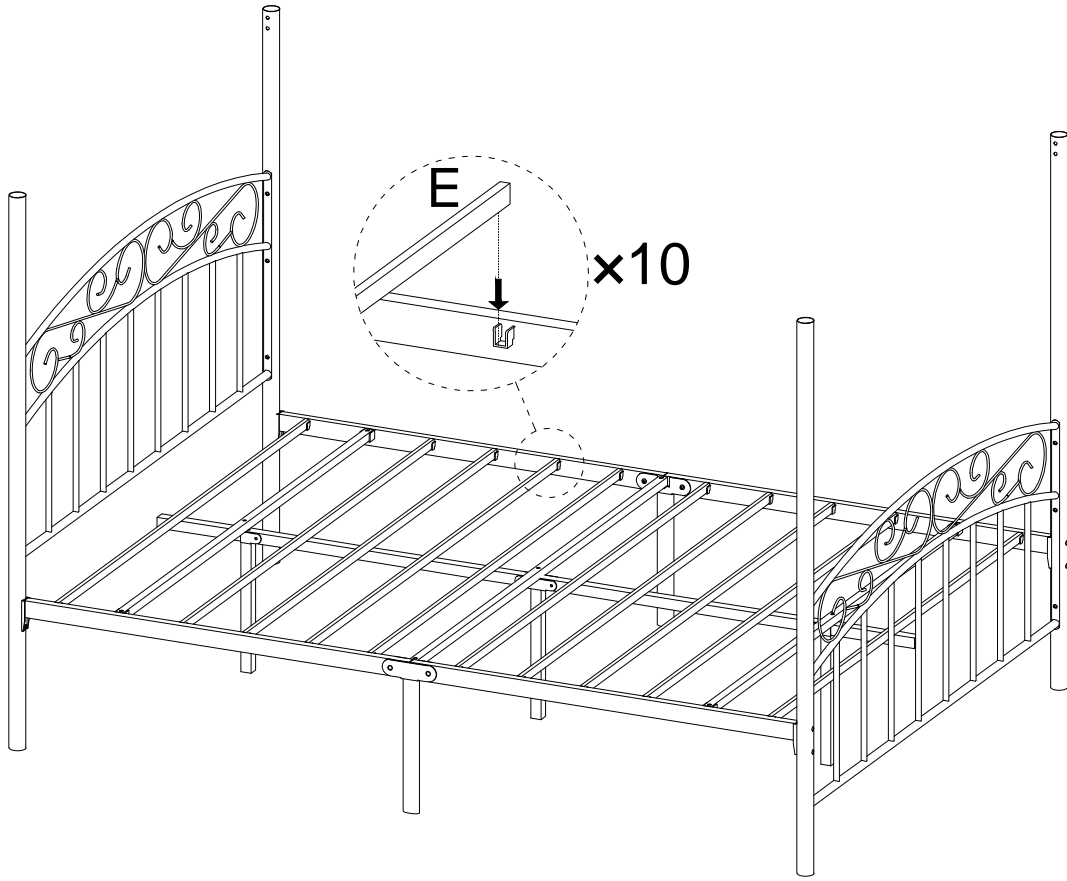



Step 7

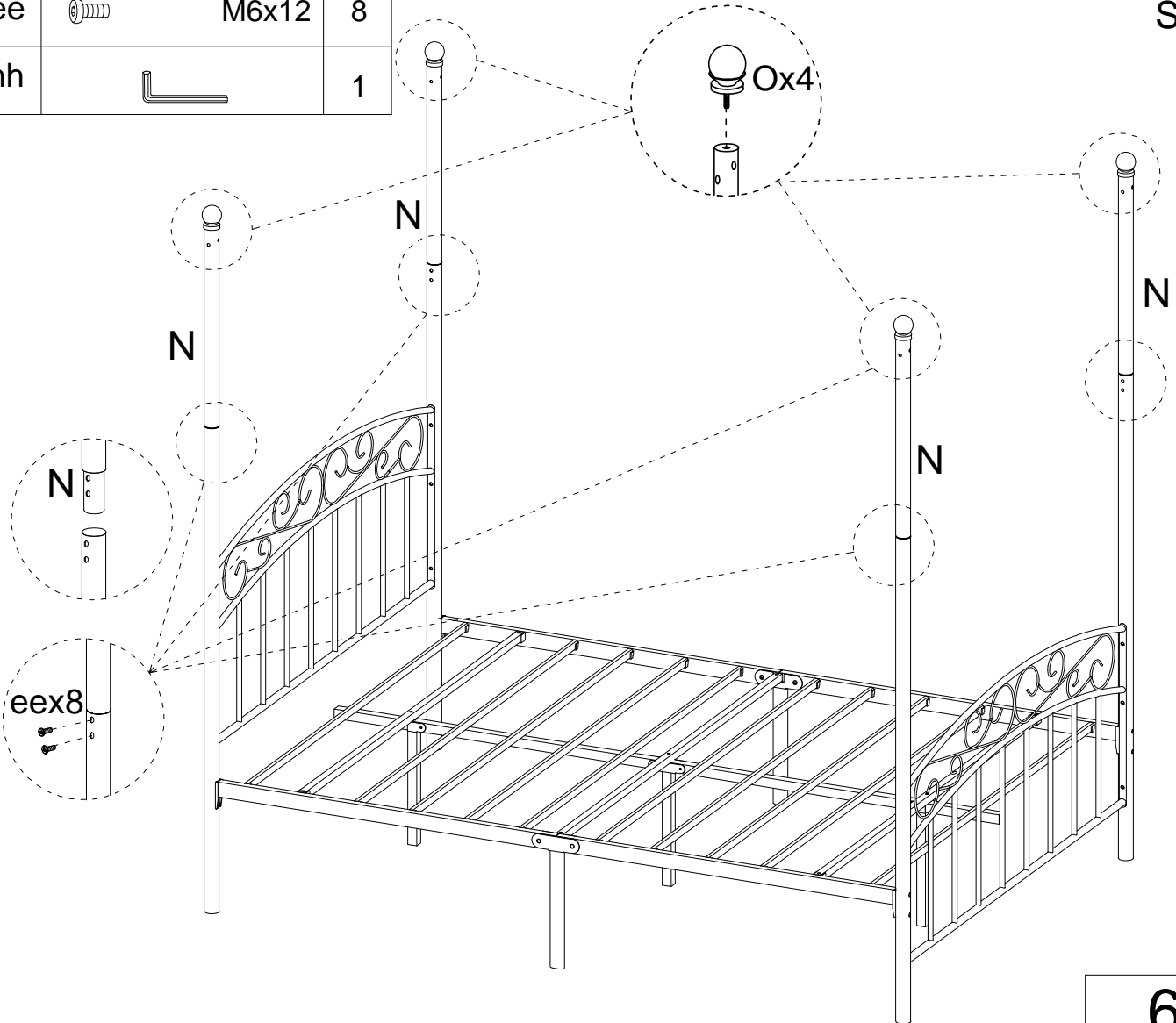

ee		M6x12	8
hh			1

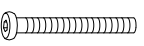
Step 8



bb		M6x55	8
ee		M6x12	4
hh			1
ff			8

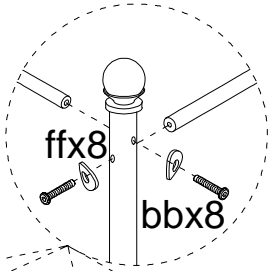
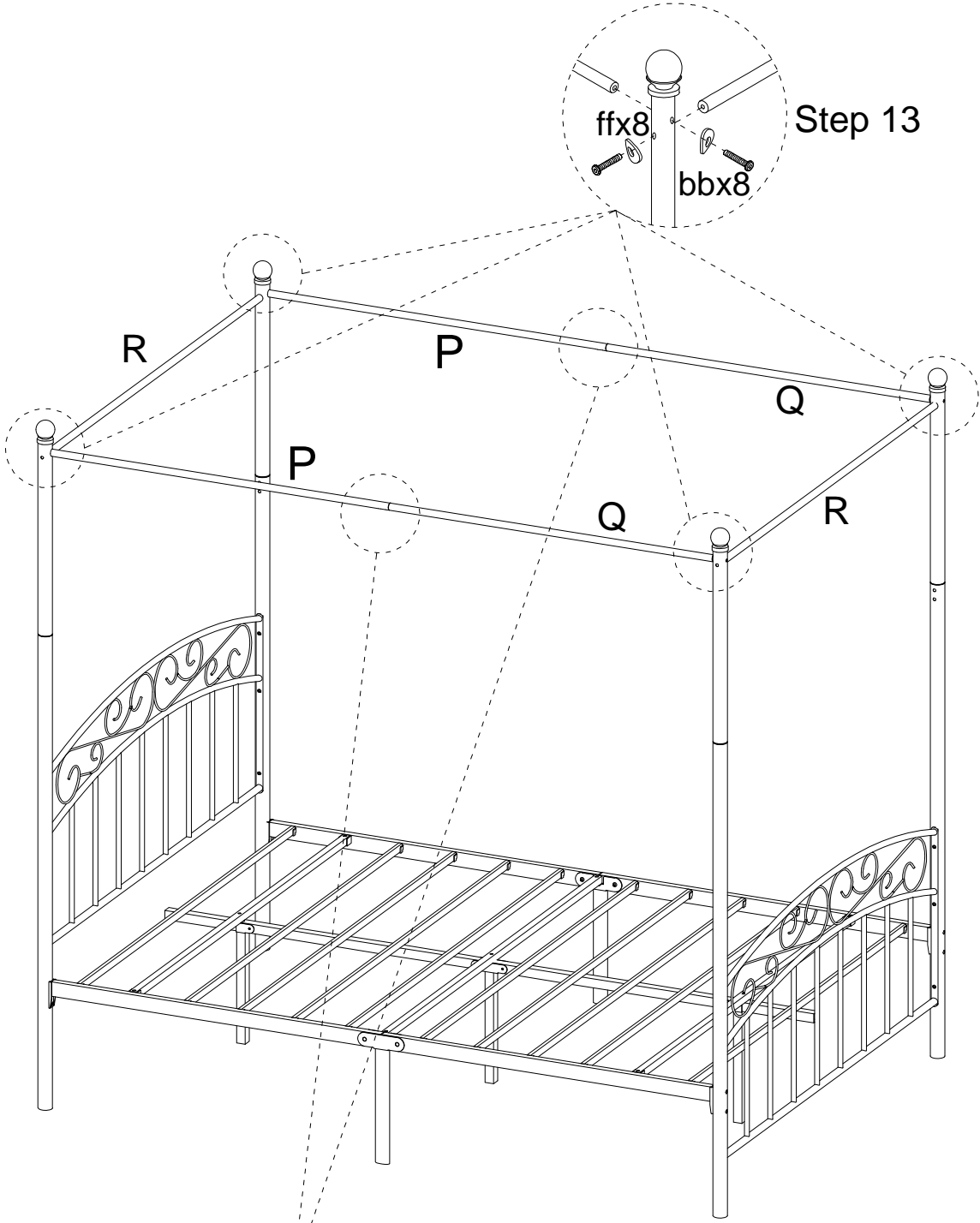

Step 13

Step 12

