

# Assembly Instructions

Caution: You must read this before you proceed

## Care & Maintenance



- Not for commercial use. For residential use only.



- Furniture may scratch floors. We recommend using furniture pads to protect your floors.



- Do not put hot items directly on furniture surface.



- Do not clean furniture with harsh cleansers or polish.



- Do not place furniture under direct sunlight.



- Do not place furniture near heating or cooling vents.



- Do not write on furniture without a padded barrier to protect the surface.



- Do not place furniture outside . For indoor use only.



- Stains may be removed with mild soap solution and damp cloth.



- Children should not climb or jump on the furniture.





- Dust and pick-up spills using a clean, non-colored, lint-free cloth.

Please look in Leg for hardware pack.

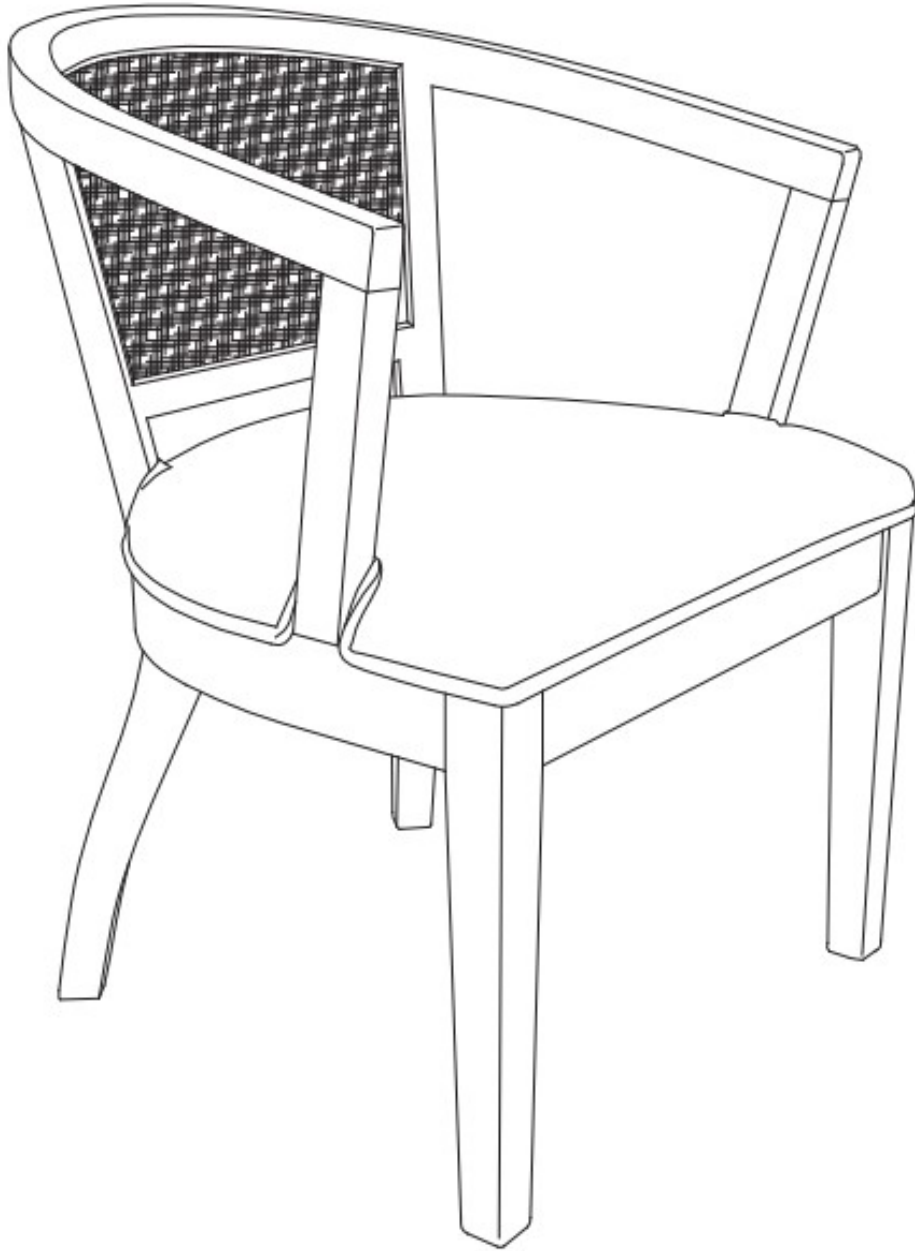

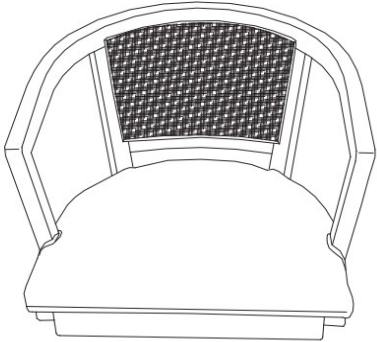

# Chair



# Part List

Label	Picture	Description	QTY
A		Seat with Back	1
B		Front Leg	2
C		Back Leg	2

# Hardware

Label	Picture	Description	QTY
①		Bolt (M8*60MM)	5
②		Bolt (M8*50MM)	5
③		Spring Washer	10
④		Washer	10
⑤		Allen Wrench	1

# Assembly Preparation

Before Beginning Assembly:

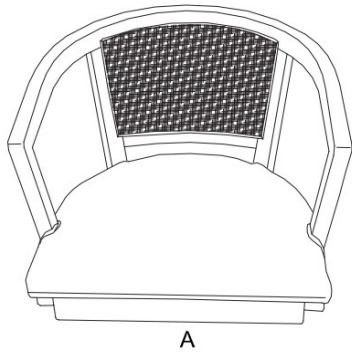

B X 2

C X 2

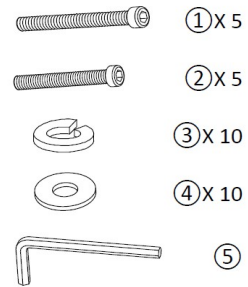

- Read instructions, cover to cover-



- Have 2 adults on hand for assembly-



- Do not assemble on flooring or carpet-



- Assemble on a clean non-marring surface (packing foam)-



- Save all packaging until finished-

# Assembly Steps

## Overview

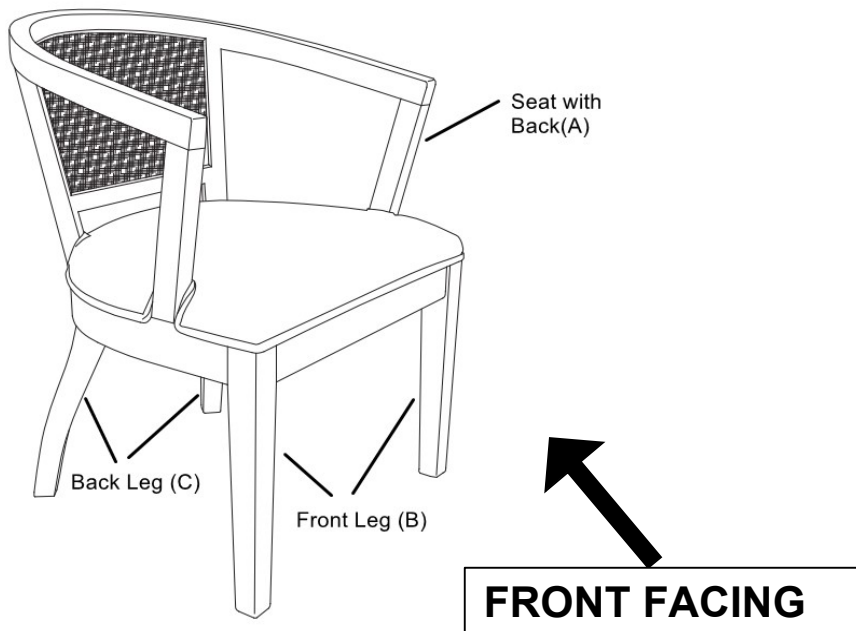

This Chair has multiple parts and may require up to 30 minutes to assemble. To give you an overview of the Chair parts, the above picture is to help you put the various parts into perspective. Please read through the instructions below to familiarise yourself with the parts and steps before assembly.

## Step 1

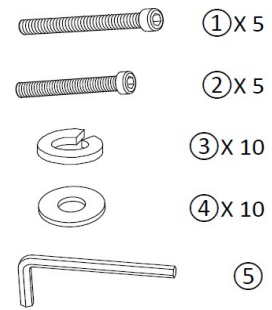
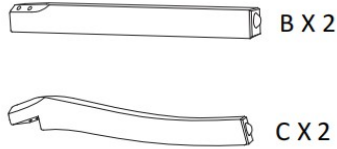
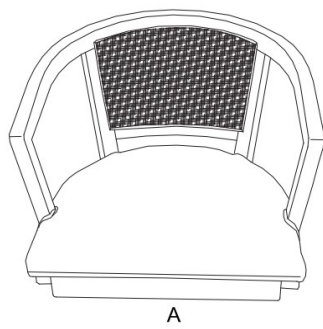

Unpack and place all parts on a clean, non-marring surface.

## Step 2

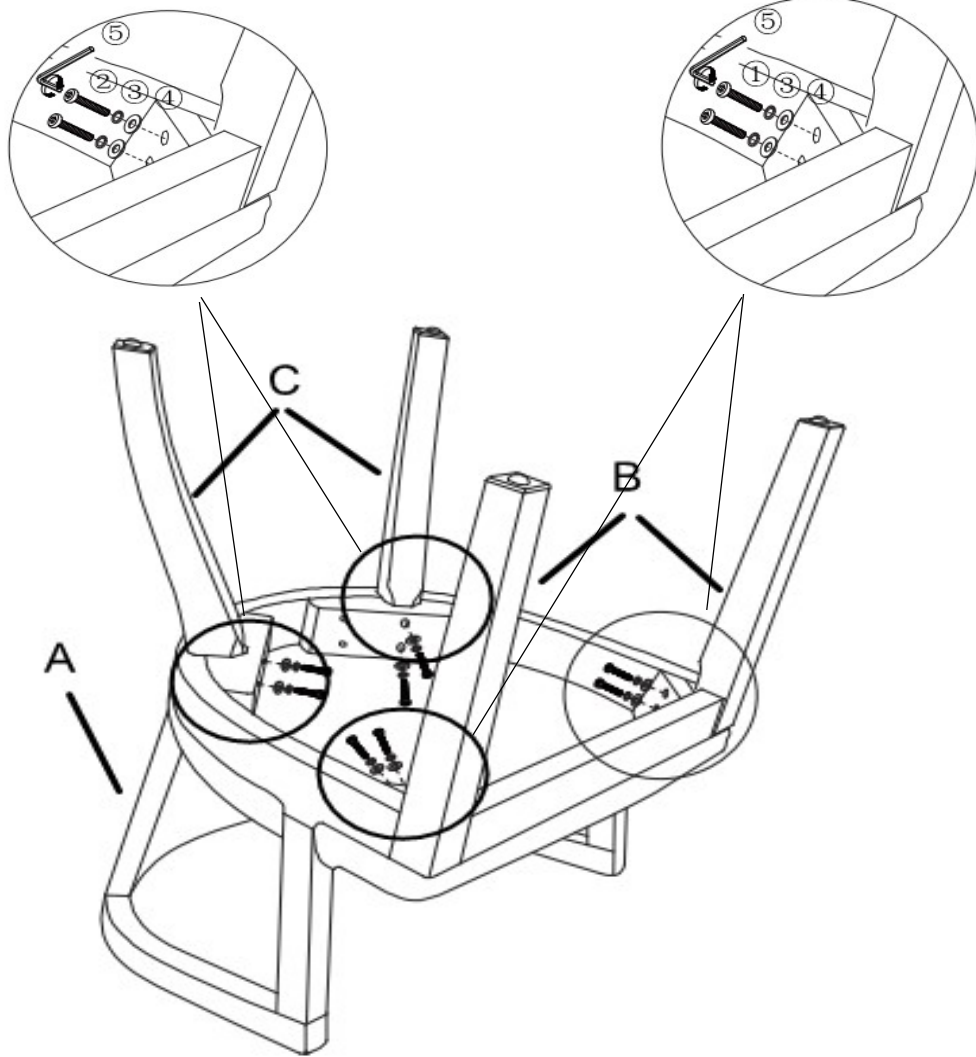

Place the Seat with Back(A) on the side of a table with the Seat facing down, as seen in the picture.

Insert Front Legs(B) into the mounting positions of Seat with Back(A) and attach using Bolts(①), Spring Washers(③) and Washers(④) with the Allen Wrench(⑤). Insert Back Legs(C) into the mounting positions of Seat with Back(A) and attach using Bolts(②), Spring Washers(③) and Washers(④) with the Allen Wrench(⑤).

**Do not fully tighten the Bolts at this time.**

### Step 3

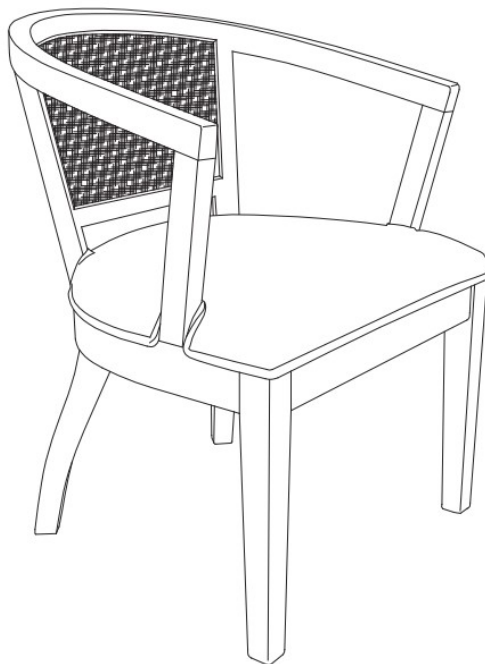

Turn the Chair right side up. Check for stability and then tighten all the remaining bolts. DO NOT fully tighten a bolt in one go and then move on to the next. Rather, in a sequential manner, gradually tighten each bolt until all bolts are evenly secured. This methodology will ensure maximum evenness once all bolts are fully tightened. If the Chair wobbles adjust the Pre-installed Levellers at the bottom of the Legs until the Chair is level. Your Chair is ready for use.

**This Chair can only be used on a flat, level surface.**