

ELINORA TRAVERTINE TABL ELAMP

DESIGN # CTL1113

Assembly Instructions

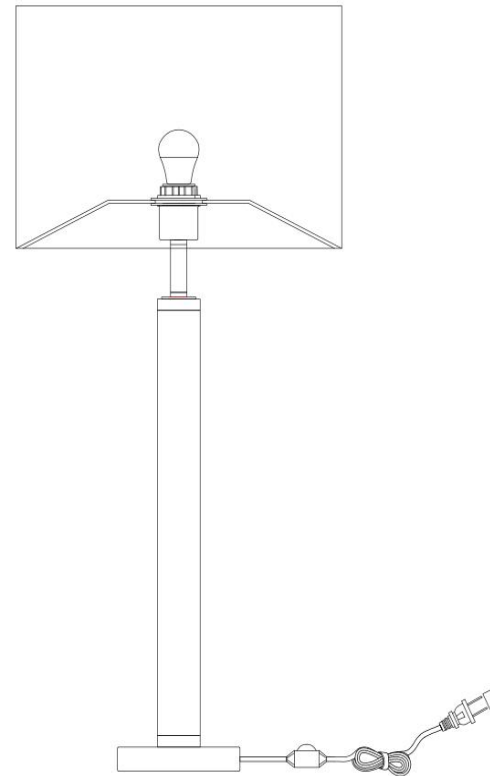

Need help?

Feel free to contact us via email or call
if you have any specific questions!

contact us:

cs@safavieh.com

866-422-9070

SAFAVIEH
C O U T U R E

Thanks for bringing Safavieh Couture into your home

Every thing we make is incredibly simple to set up, including your new table lamp. You won't need any additional tools

Parts List

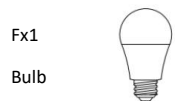
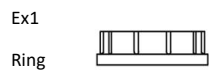
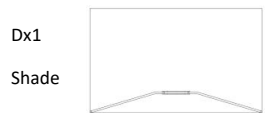
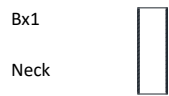
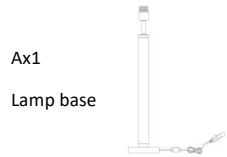

1

Pull power cord to connect the Neck (B) to the Base (A). Screw the Neck (B) onto the Lamp base (A). Be careful not to twist the power cord and tighten securely. Put the shade (D) onto the socket (C) and tighten with the ring (E) clockwise!

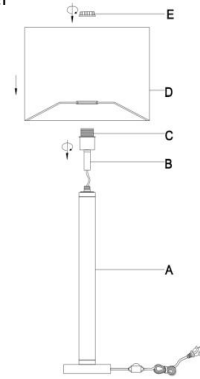

2

Insert the bulb (F) into the socket (C).

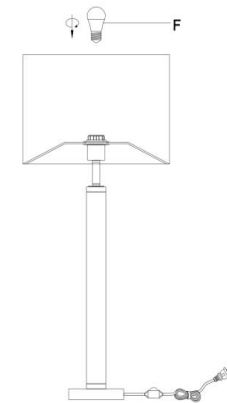

3

Put the light on a level surface to check if everything is stable. We'd love to see it — just tag us (we're @safavieh) and use the hashtag #safavieh on Instagram!

