

ASSEMBLY INSTRUCTION L

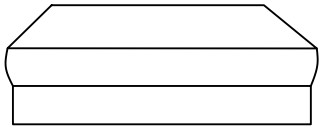

A*1

Seat Cushion Base with Storage

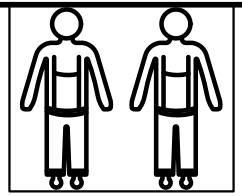
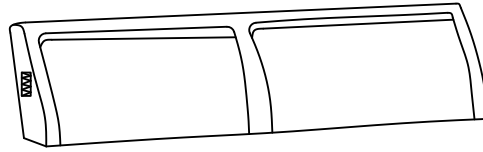

B*1

Back Support

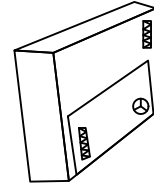

C*1-LEFT

Left Armrest

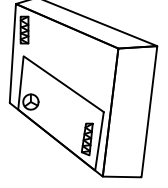

C*1-RIGHT

Right Armrest

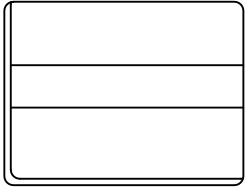

D*2

Back Cushion



E*2

Throw pillow

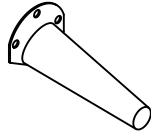

F*2

Back Legs



G*2

Front Legs

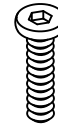

H*6

Screws



I*1

Allen Wrench



J*4

Anti-Slip Pads

STEP 1

Place Part A (Seat Cushion Base with Storage) upside down

Locate the zipper on the bottom side and unzip it to access the internal compartment.

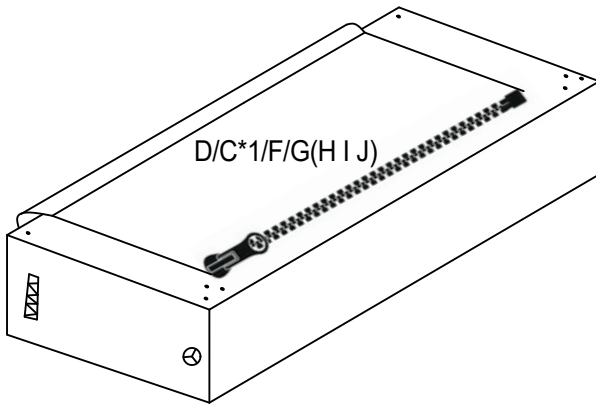

Remove Part D (Back Cushion) from the compartment. Inside, you will also find Parts C*1 and F/G (Legs), as well as the hardware kit including H, I, and J.

STEP 2

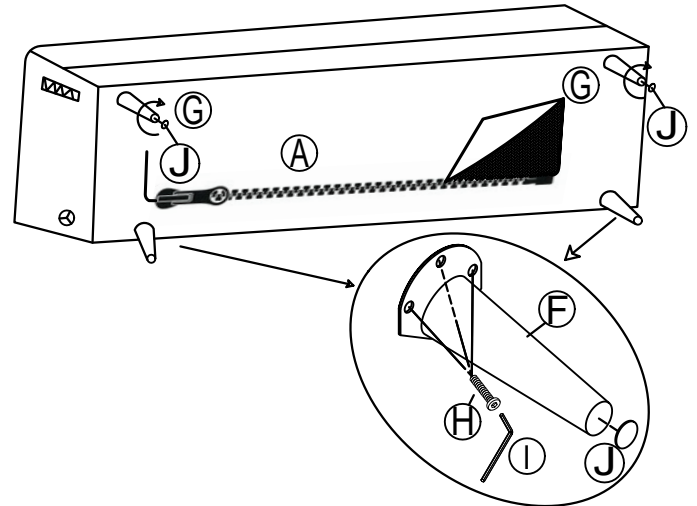

STEP 3

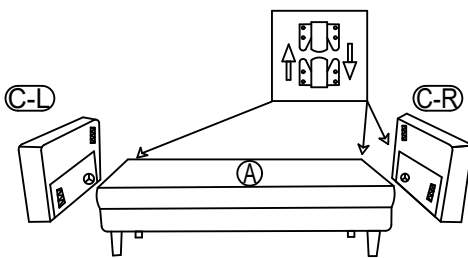

STEP 4

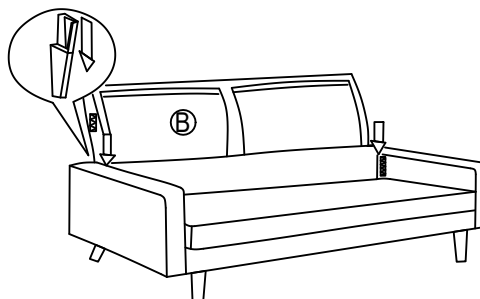

STEP 5

