

# MANUAL INSTRUCTIONS

Camping Gazebo Screen Tent

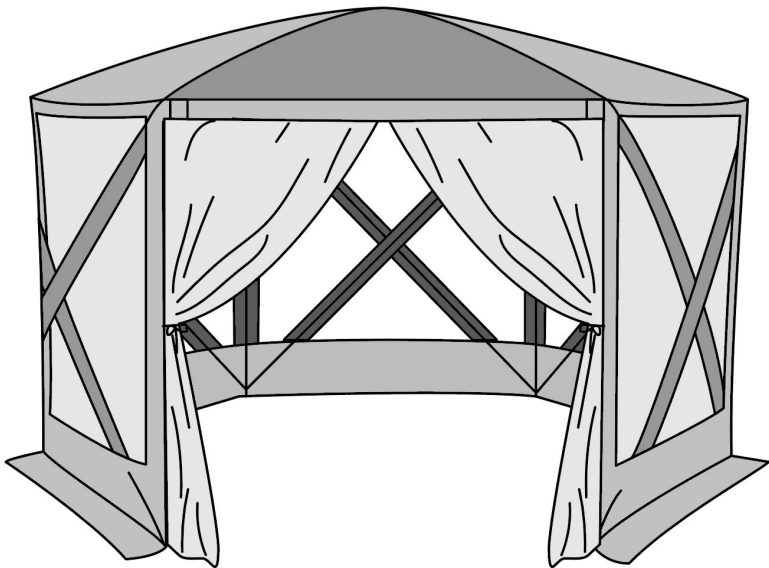

---

✉ (24/7): [service@kmcglobe-us.com](mailto:service@kmcglobe-us.com)

☎ (USA) +1 213-816-4788

## **ASSEMBLY AND SAFETY INSTRUCTIONS**

Please pay close attention to the following instructions in order to reduce the risk of injuries, accidents or damage to the product by itself.

### **IMPORTANT**

Please follow ALL safety instructions listed below.

Please remove the packaging material before assembling or using the product.

Please make sure that all listed parts are included in the package and that they are not damaged.

Please read these assembly and safety instructions carefully before usage of the tent and keep it for future reference.

This product should only be used in a non-commercial way.





### **SAFETY INFORMATION**

The tent was not tested for wind and snow loads, unless that is clearly indicated otherwise. Therefore, these loads are not covered by guarantee. Please watch the weather forecasts to be able to properly protect or disassemble the tent before problems appear. Tents should only be used as temporary accommodation and should be disassembled in adverse weather conditions.

Make sure to keep sufficient distance to houses as well as gas and power lines to avoid possible damage. Please check the area for power cables and gas lines. Ask your local authority for further information if needed.

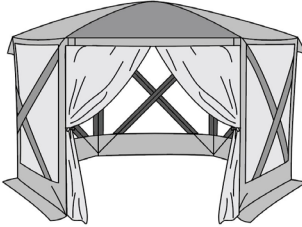
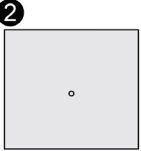
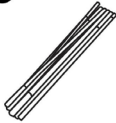
When making use of suitable heaters, keep a minimum distance of 1.2 m to tarp material. Open fire or heaters with open flames such as patio heaters, umbrella heaters, gas heaters etc. should NOT be used inside the tent in any case.

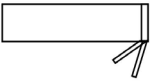
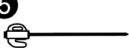
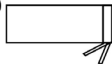
# Components

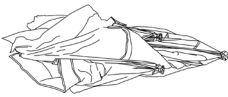
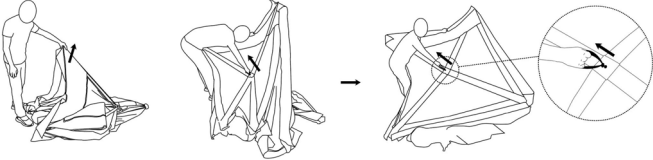
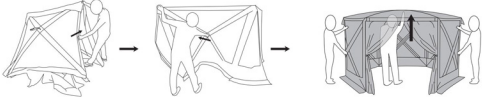
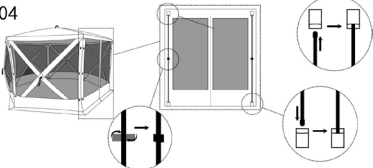

			
			
			
			
<p>1. Tent *1 2. Cover cloth *6 3. Fiber rod *2</p>	<p>4. Camp rope *5 5. Camp nail *11 6. Carrying Bag *1</p>	<p>7. Pole Bag *1 8. Pegs &amp; Ropes Bag *1 9. Tying rope *2</p>	

## Assembly instructions:

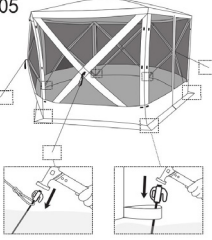
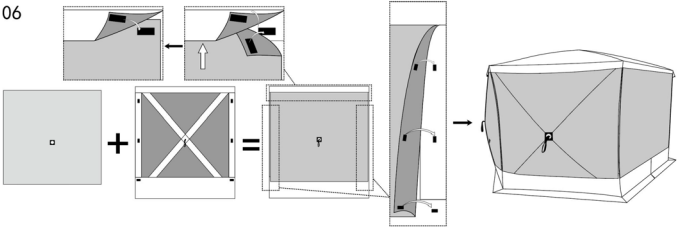
<p>01</p> 	<p>02</p> 		
<p>Open the packaging and remove the tent and accessories.</p>	<p>Spread out the tent, find the pull rope in the middle of one side (as shown in the picture), and pull it up.</p>		
<p>03</p> 	<p>04</p> 		
<p>According to the second step, continue to pull apart the other sides, and finally have someone hold down both sides of the tent. One person enters the inside of the tent to lift the top.</p>	<p>Enter the inside of the tent and use 2 fiber poles to support the door as shown in the picture.</p>		

<p>05</p> 	<p>06</p> 
<p>Fix the corners with ground nails, tie the camp ropes, and then fix them with ground nails.</p>	<p>After the construction is completed, the matching cover can also be used to fix it on the six sides of the tent with Velcro on the cover, providing shade and rain protection.</p>

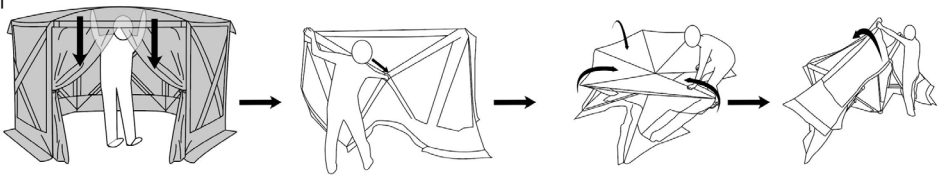
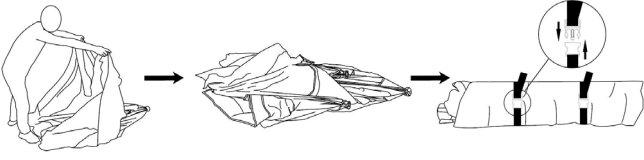
### Storage instructions:

<p>01</p> 	
<p>After removing accessories such as ground nails, camp ropes, fiber poles, and covers, first enter the tent and drag the top down. Then, press each side inward and fold the bracket together.</p>	
<p>02</p> 	<p>03</p> 
<p>After fully folding and closing, tie the folded tent tightly with a ribbon.</p>	<p>Put the folded tent and accessories into a storage bag to complete storage.</p>