

ASSEMBLY INSTRUCTION

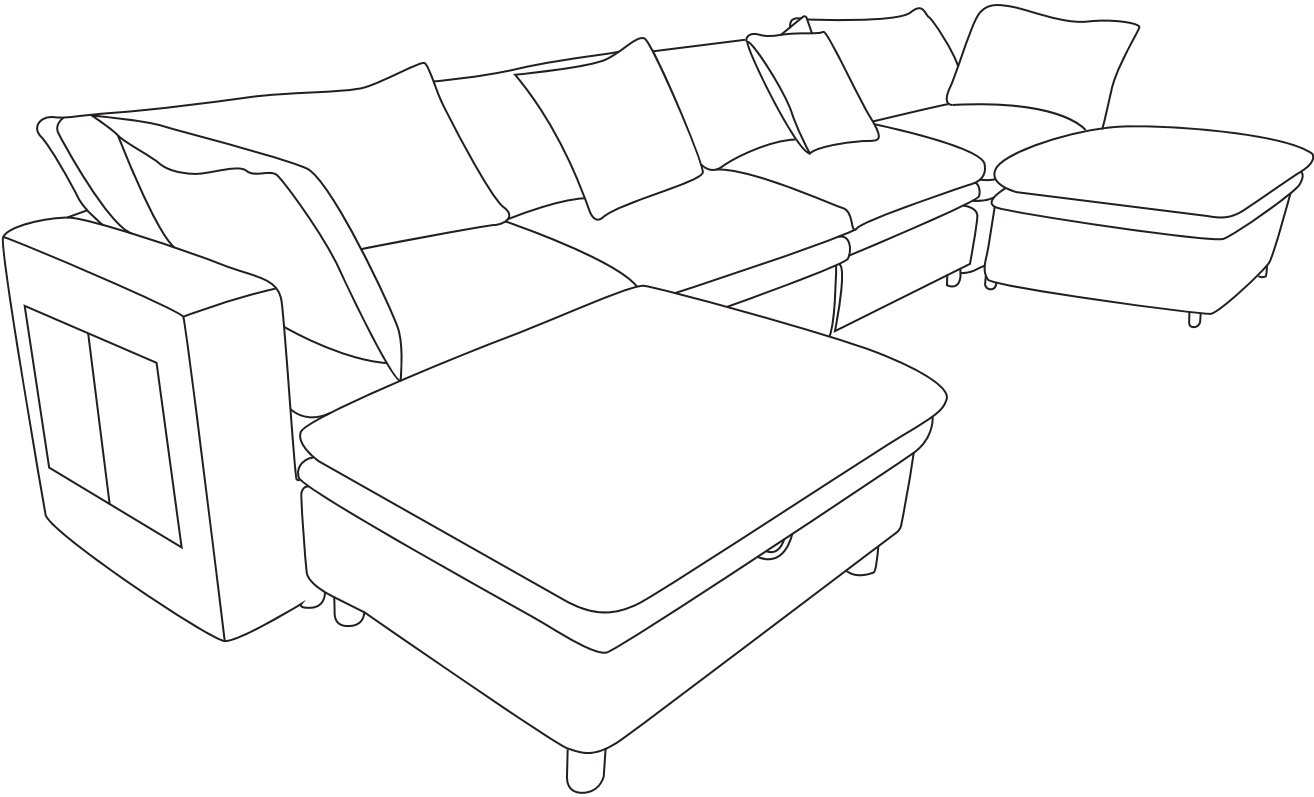
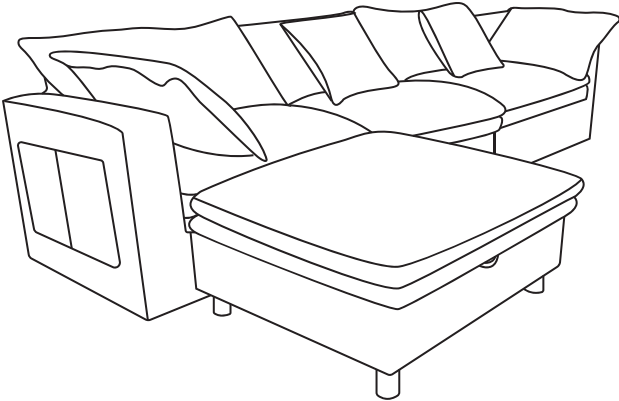
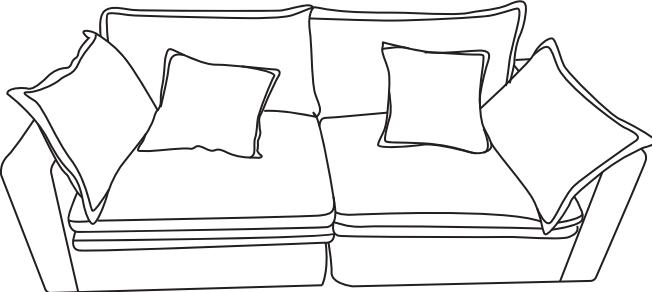

Modular Sofa

PLEASE READ BEFORE ASSEMBLY

1. Follow the assembly steps in order; do not skip any.
2. Assemble in a spacious area, away from infants and children. Protect the floor with packaging material before starting.

CAUTION

1. To ensure safe transportation, the product has been vacuum-compressed and may take up to 3-7 days to regain its original shape.
2. When cleaning, please use a soft cloth to gently wipe the surface or use professional cleaning supplies. Avoid using chemical agents or abrasive cleaners.
3. During use, please do not exceed the product's maximum weight capacity. Exceeding this limit may damage the product or pose a risk of injury.
4. For safety reasons, do not leave infants unattended on the product to prevent any risk of harm, such as suffocation.
5. The product may differ slightly in appearance from the assembly illustrations.
6. The packaging contains plastic bags. Keep them away from infants and children to avoid suffocation. After unboxing, dispose of the bags immediately; do not reuse them.

RETURN POLICY

We understand that you may have concerns about returning the product due to its vacuum-compressed nature. Please note that once the product is unpacked and expanded, it cannot be re-compressed to its original state for return. However, if you encounter any issues or are unsatisfied with your purchase, we are here to help. Please contact us through your order page, and we will assist you with any concerns or provide further instructions.

please take all packages out and pat every part to make it rebound better and fluffy, so that it can restore to picture-like status.

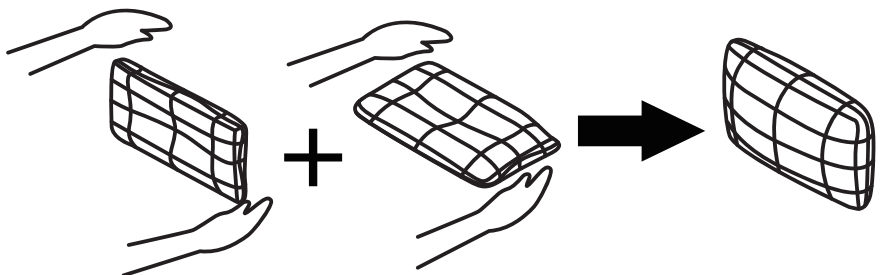

1. repeatedly tap the sides and front and back to make it rebound better and fluffy.
2. knead your cushion like giving your cushion a massage while allowing the air to flow through the foam.

 Please remove the accessory box from the armrest **B** before installation.

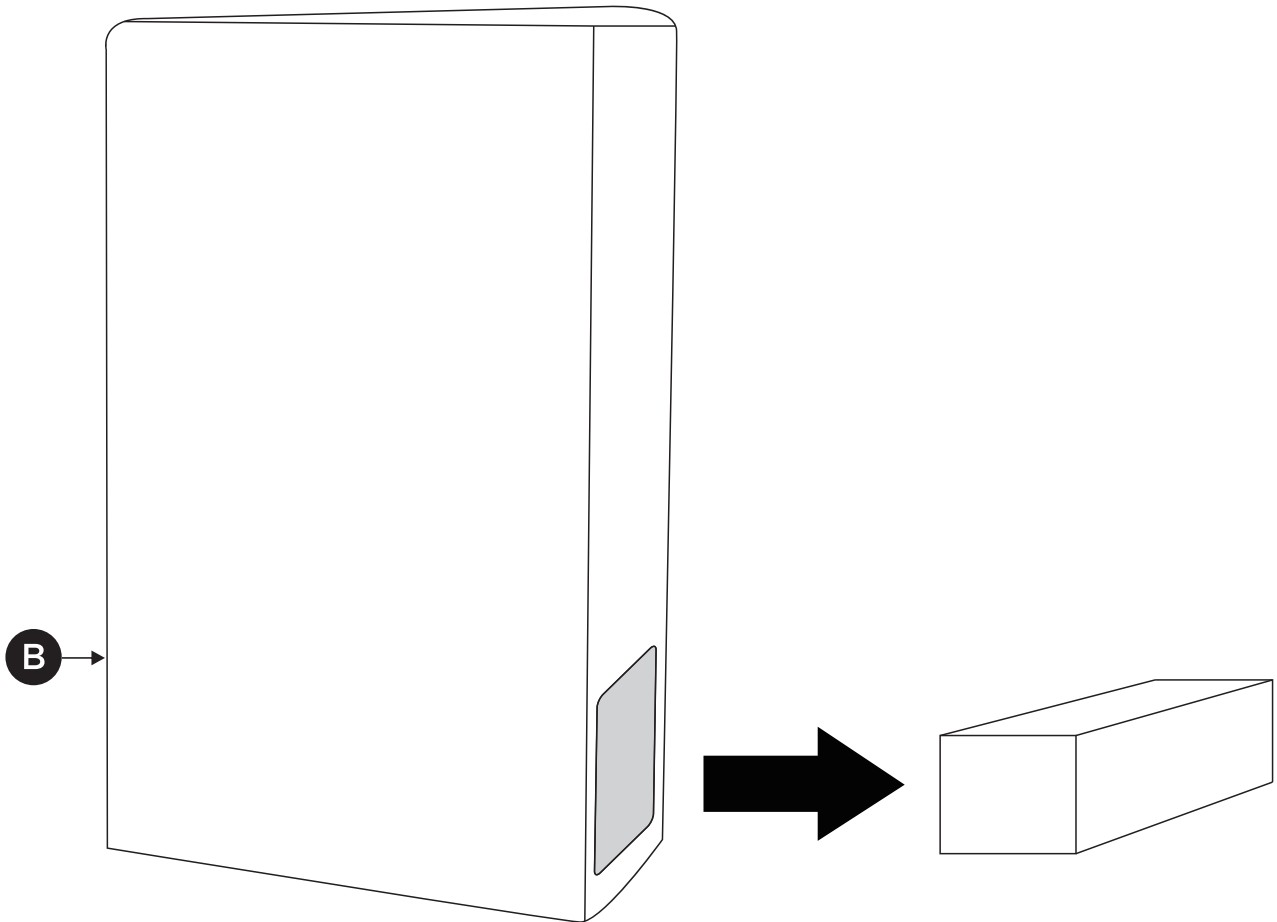

 **Caution**

Two people are recommended for safe and efficient assembly.

Before assembly, ensure the floor is clean and free of debris to prevent soiling, especially for light-colored upholstery.

List of items in the cardboard boxes (total of 3 cardboard boxes):

The following is a detailed list of items in boxes **A**, **B**, and **C**



Loveseat
Box-A+Box-C

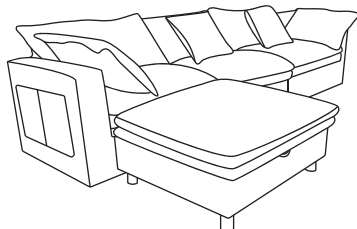

3+1
Box-A+Box-B+Box-C

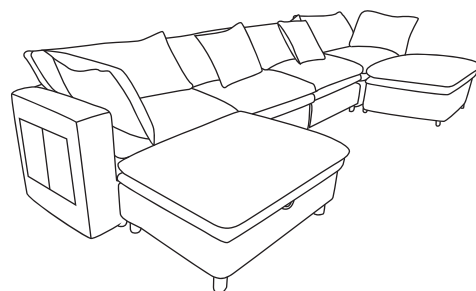

4+2
Box-A+Box-B+Box-B+Box-C

PART LIST Box-A

(C)

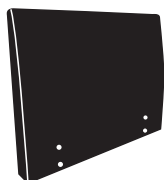

Backrest*2

(D)

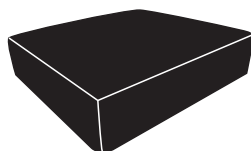

Couch Cushion*2

(F)

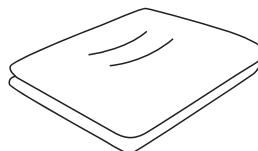

Soft Cushion*2

(R)



Left Sofa
Seat Cover*1

(S)



Right Sofa
Seat Cover*1

PART LIST Box-B

C

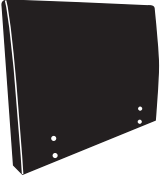

Backrest*1

D

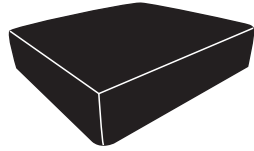

Couch Cushion*1

F

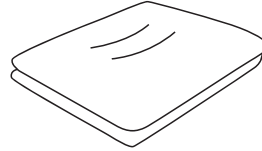

Soft Cushion*2

E

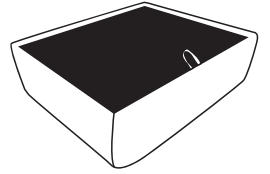

Ottoman Cushion*1

G

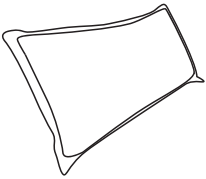

Back Cushion*1

T



Middle Sofa
Seat Cover*1

N

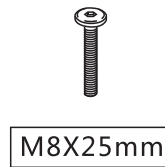

Screw Bolt*12

J

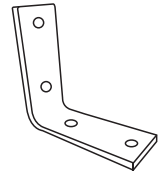

L-shaped Link
Piece*2

P



Allen Key*1

K



Connecting parts*2

O



Washer*8

M



Sofa Legs*8

PART LIST Box-C

A

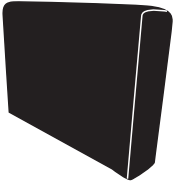

Right Armrest*1

B

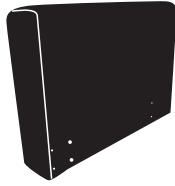

Left Armrest*1

C

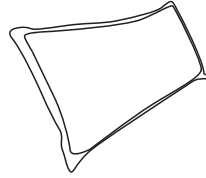

Back Cushion*2

I

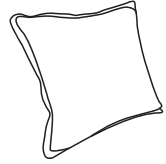

Square Throw
Pillow*2

H

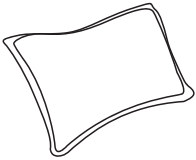

Pillow*2

J

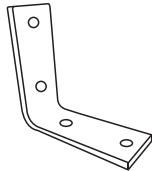

L-shaped Link
Piece*8

K



Connecting parts*6

O



Washer*8

P



Allen Key*1

M



Sofa Legs*8

N



M8X25mm

Screw Bolt*44

INSTALLING THE SIDE SEAT STEPS

Step 1

Following the diagram, insert the sofa leg **M** through the washer **O** and install it onto the couch cushion **D**.

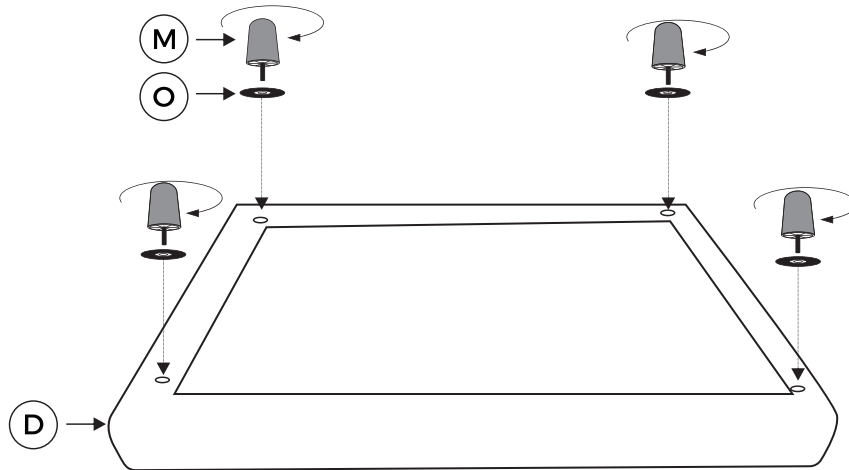
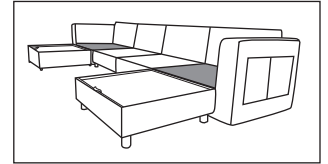

Step 2

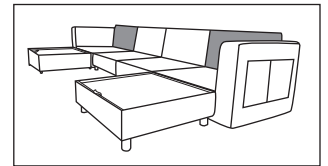

According to the diagram, use the Allen key **P** and Screw bolt **N** to install the L-shaped Link Piece **J** onto the backrest **C**.

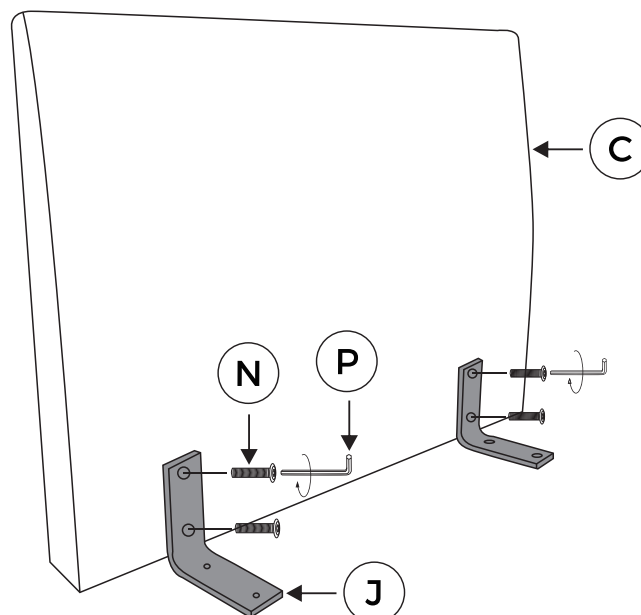

Step 3

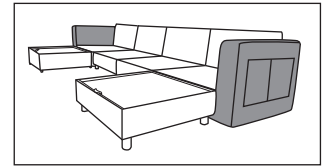

According to the diagram, use the Allen key **P** and Screw bolt **N** to install the L-shaped Link Piece **J** onto the Armrest **A/B**.

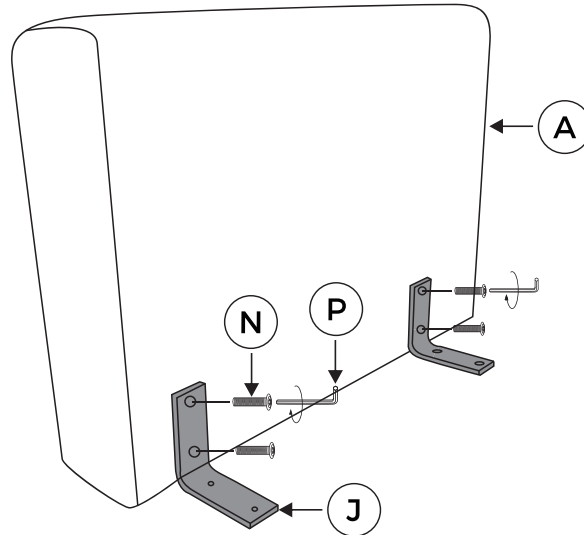

Step 4

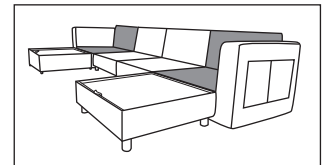

Following the diagram, place the couch cushion **D** on the backrest **C**, align the holes, and use the Allen key **P** and Screw bolt **N** to connect the couch cushion **D** and the backrest **C** together.

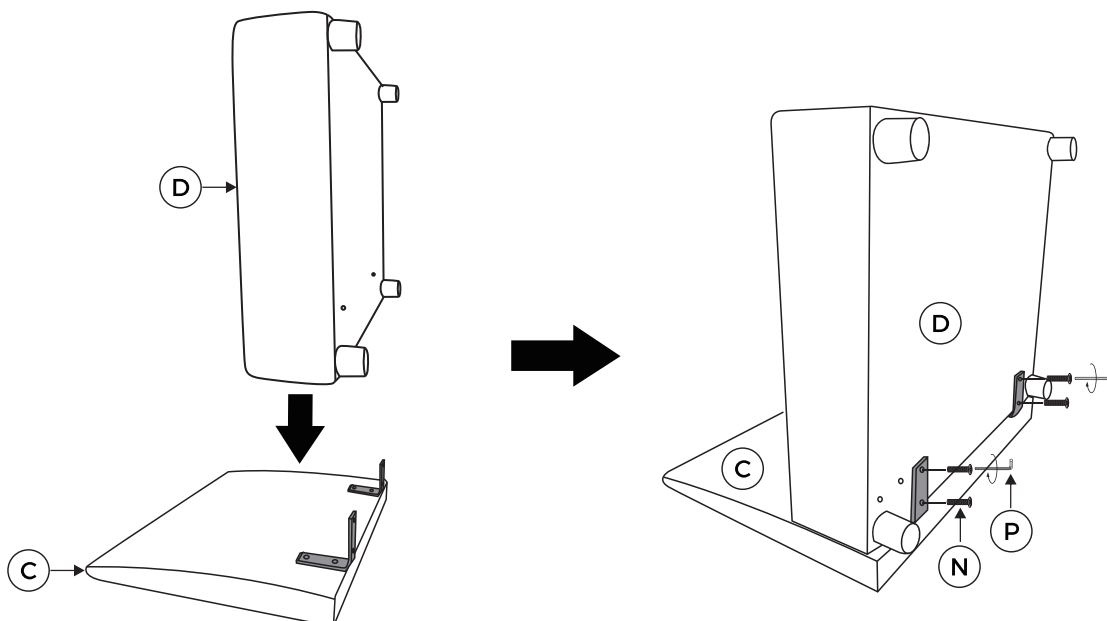

Step 5

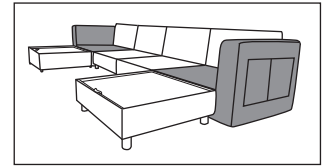

Following the diagram, place the left armrest **B** to the left of the couch cushion **D**, aligning it with the holes. Use the Allen key **P** and Screw bolt **N** to connect the couch cushion **D** and the left armrest **B** together. Repeat the above steps to place the right armrest **A** to the right of the other couch cushion **D**, thus completing the installation.

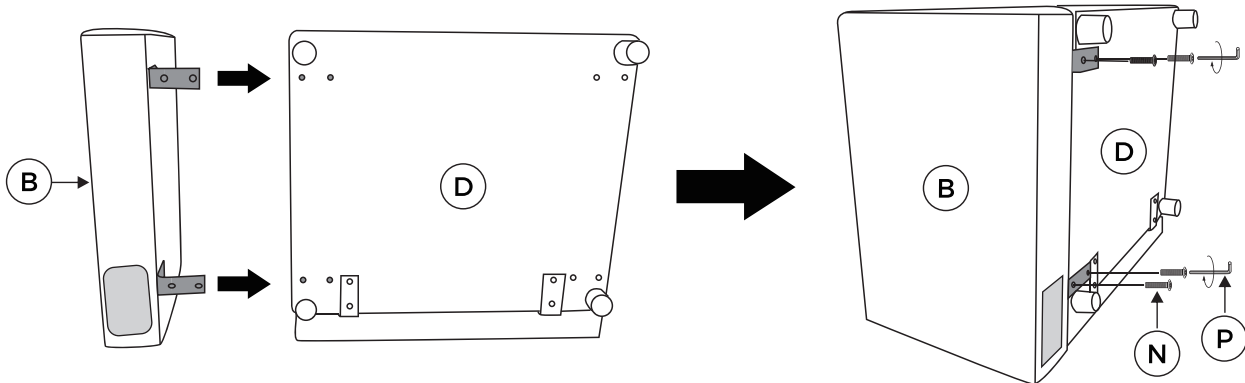

Step 6

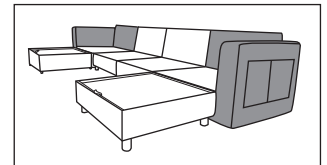

Following the diagram, use an Allen key **P**, Screw bolt **N**, and long Assembly Piece **K** to connect the left armrest **B** and backrest **C**. Connect the right armrest **A** and backrest **C** in the same way.

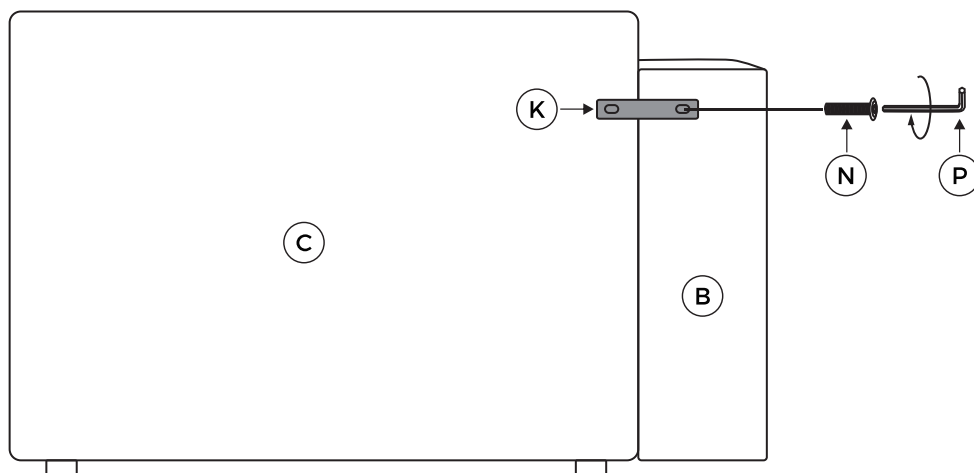

Step 7

Cover with the sand cover; the side seat is installed.

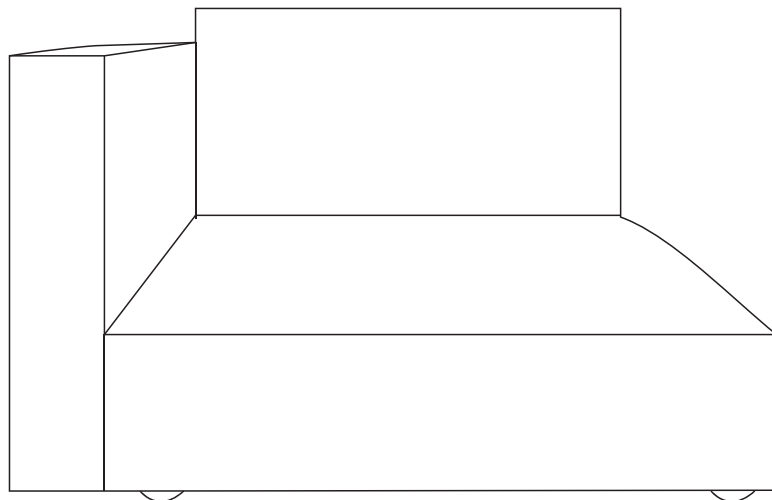
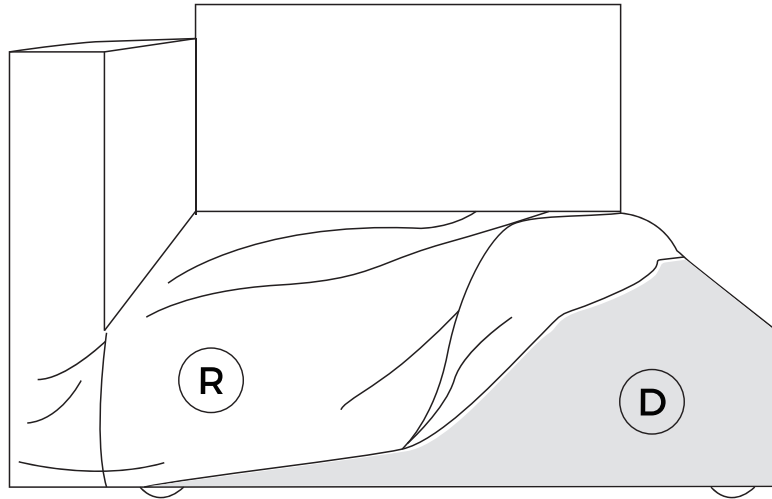

MIDDLE SEAT INSTALLATION STEPS

Step 1

Following the diagram, insert the sofa leg **M** through the washer **O** and install it onto the couch cushion **D**.

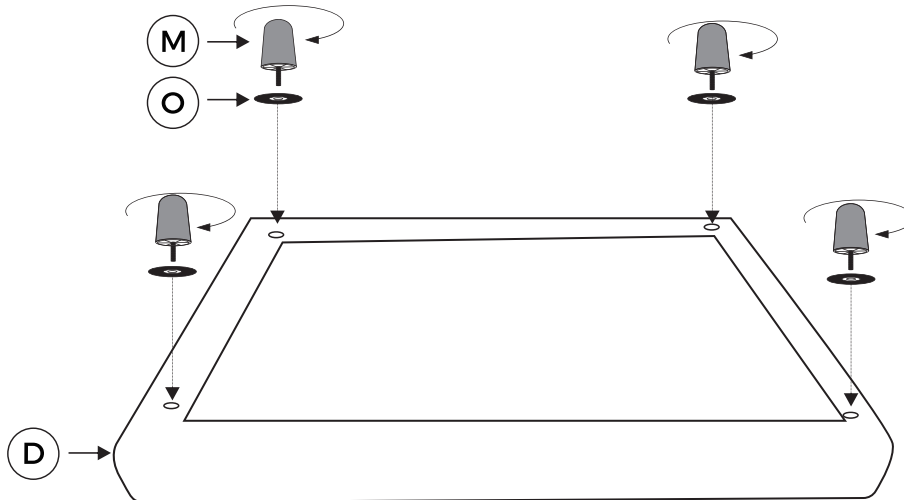
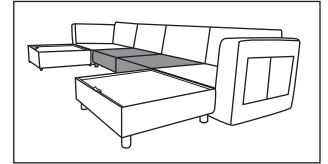

Step 2

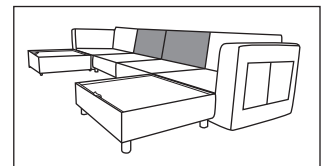

According to the diagram, use the Allen key **P** and Screw bolt **N** to install the L-shaped Link Piece **J** onto the backrest **C**.

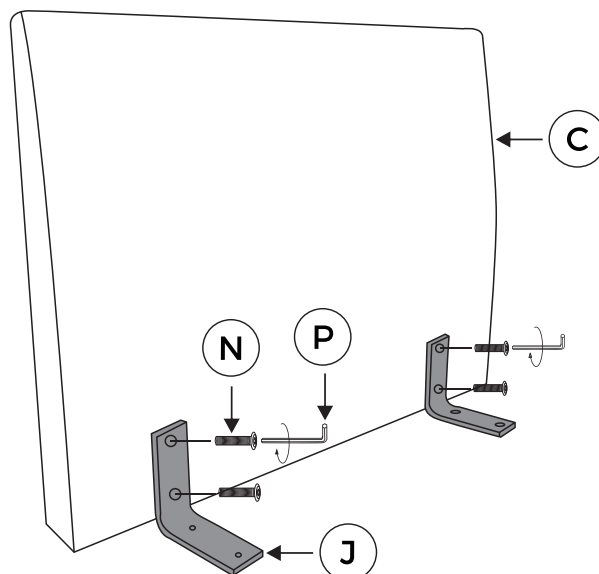

Step 3

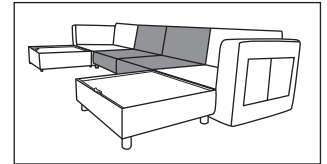

Following the diagram, place the couch cushion **D** on the backrest **C**, align the holes, and use the Allen key **P** and Screw bolt **N** to connect the couch cushion **D** and the backrest **C** together.

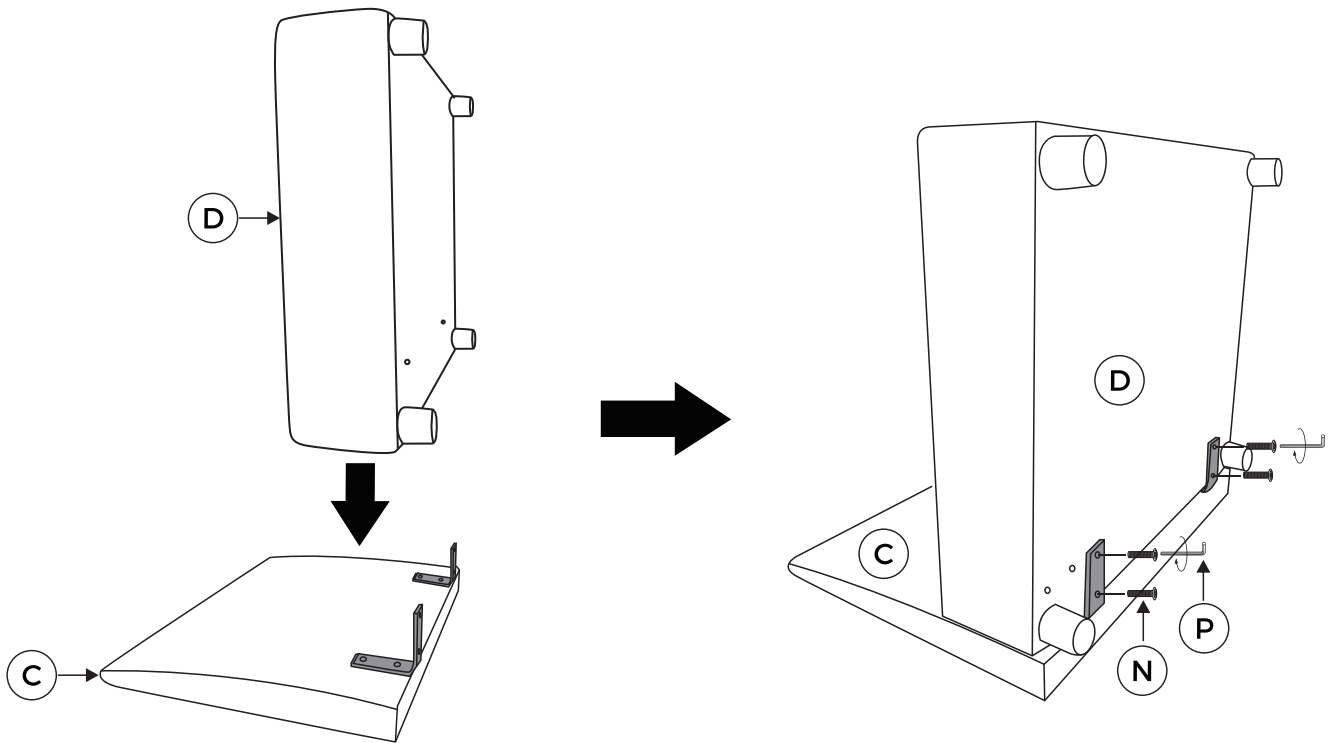

Step 4

Cover with the sand cover; the side seat is installed.

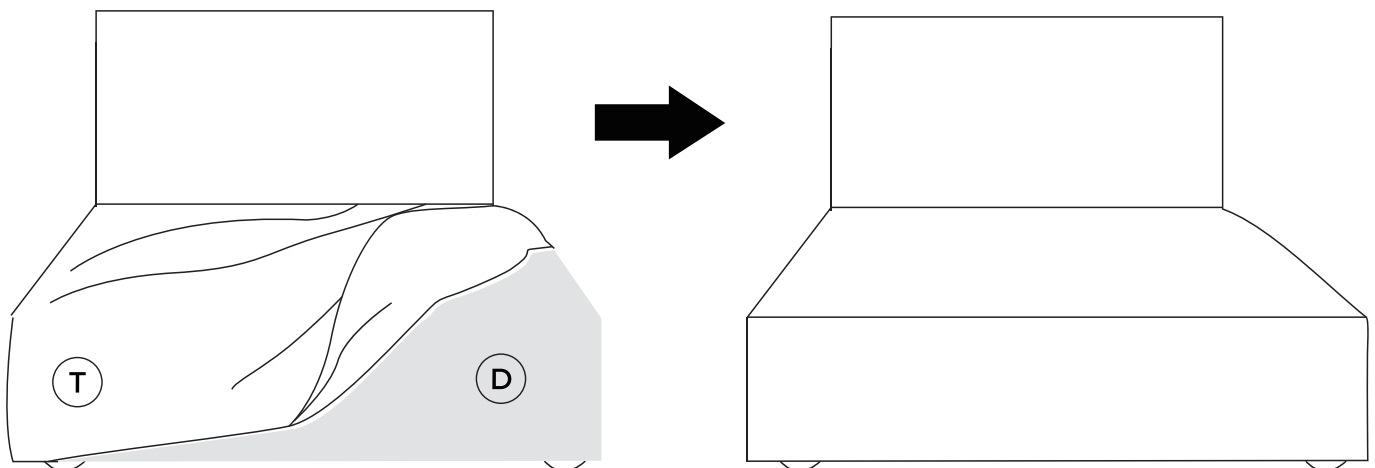

OTTOMAN INSTALLATION STEPS

Step 1

Following the diagram, insert the sofa leg **M** through the washer **O** and install it onto the ottoman cushion **E**.

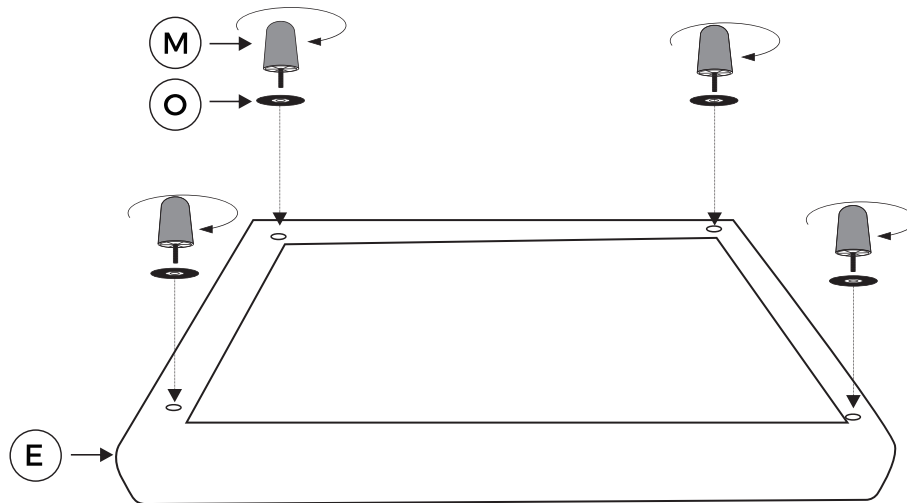
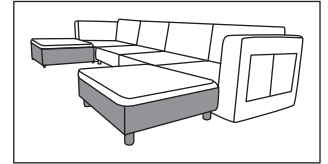

Step 2

As shown in the diagram, place the soft cushion **F** on the ottoman cushion **E**, making sure the zipper opening is on the inside of the sofa.

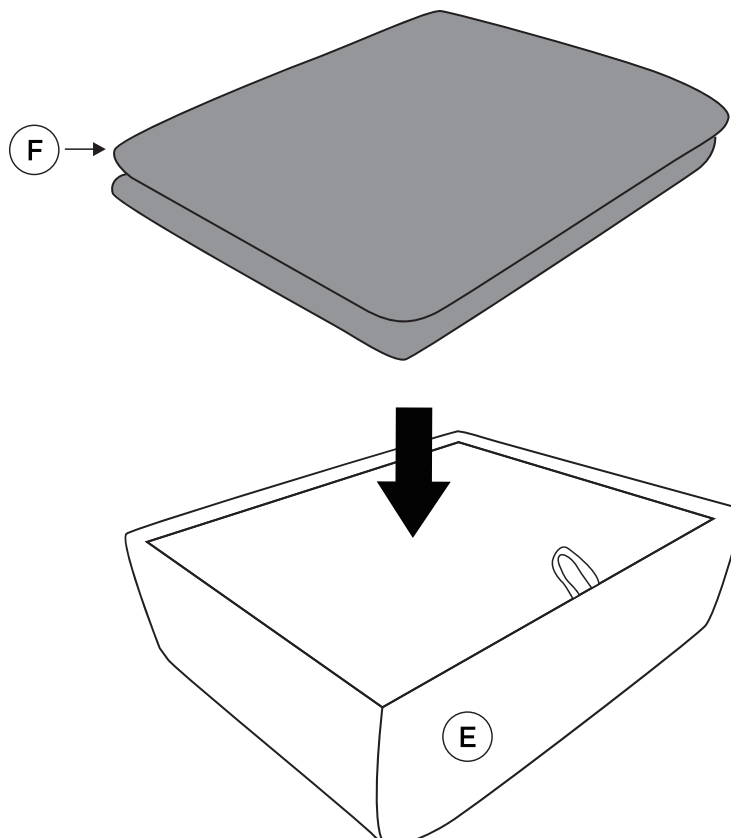
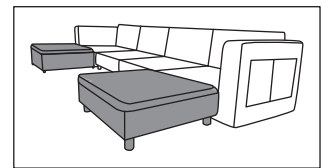

Step 3

Ottoman Installed

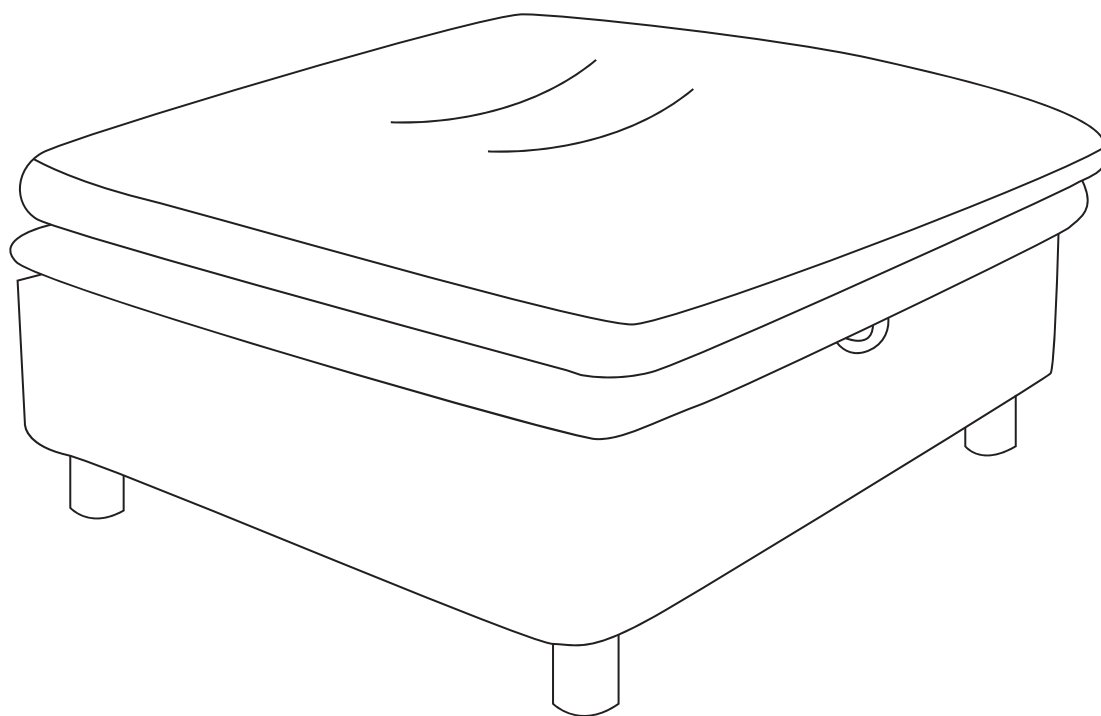

SOFA COMBINATION INSTALLATION STEPS

Step 1



According to the diagram, expose the bottom of the sofa, align it with the holes, and use the Allen key **P**, Screw bolt **N** and short assembly part **K** to connect the seats.

Below The Sofa

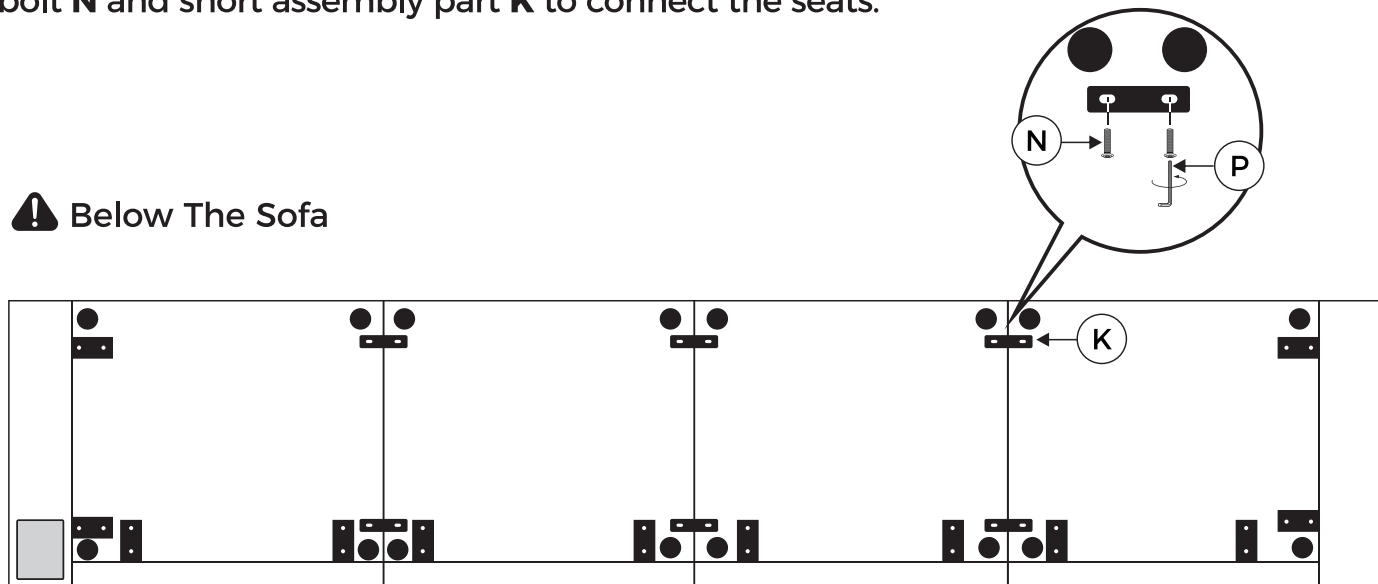

Step 2

Following the diagram, place soft cushion **F** on each seat in sequence, making sure the zipper opening is on the inside of the sofa.

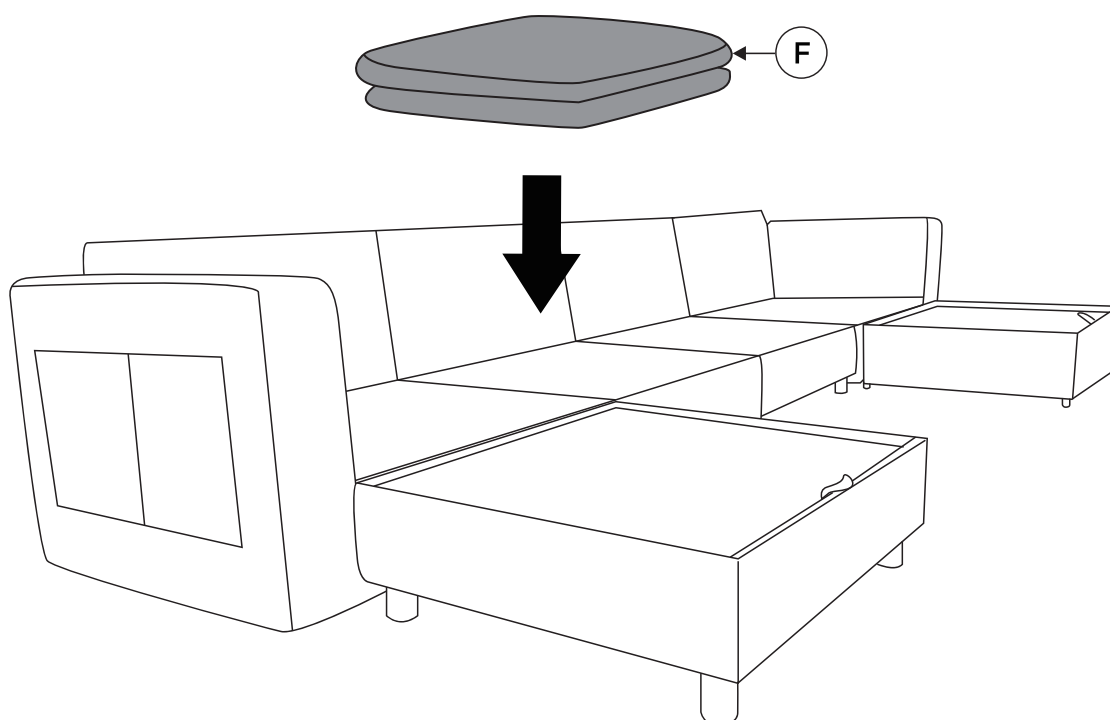
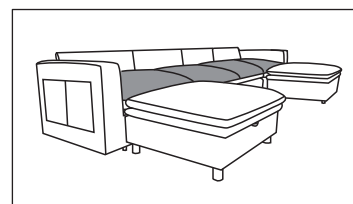

Step 3

Following the diagram, place the back cushion **G** on each seat in turn, making sure the zipper opening is facing down.

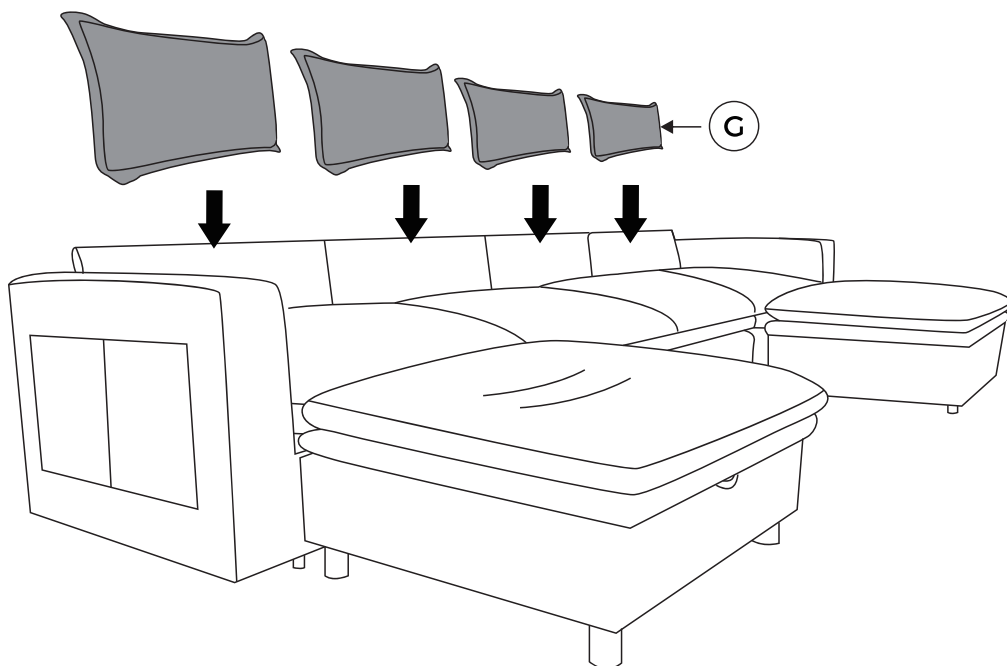
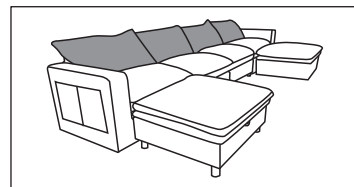

Step 4

Following the diagram, place the pillow **H** and square throw pillow **I** on each seat in sequence, making sure the zipper opening is facing down.

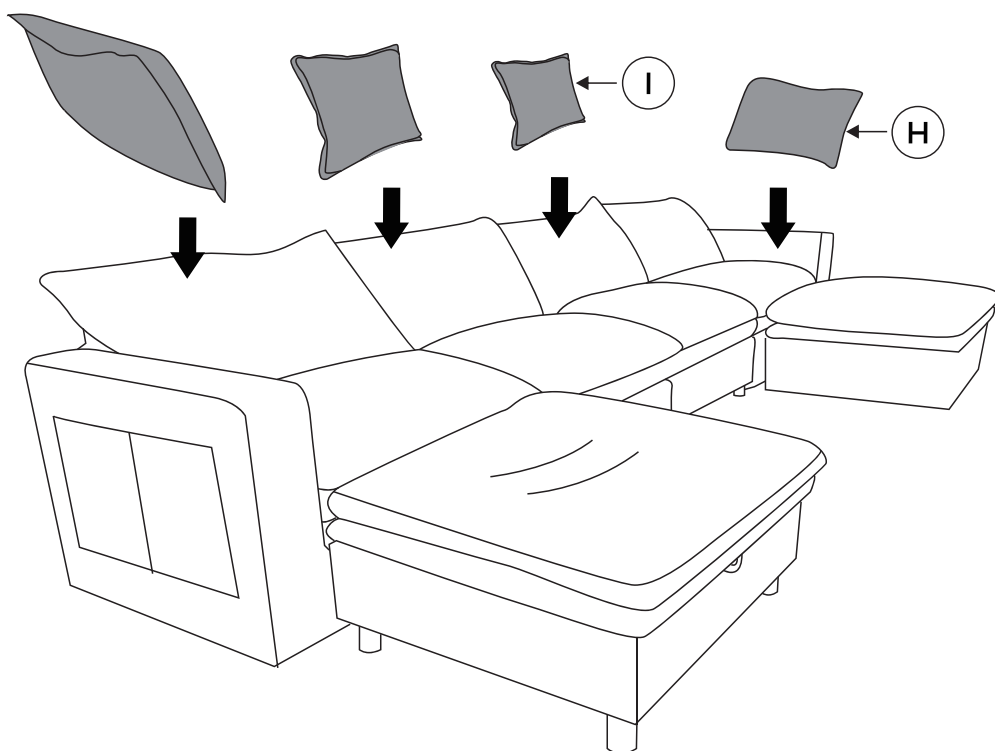
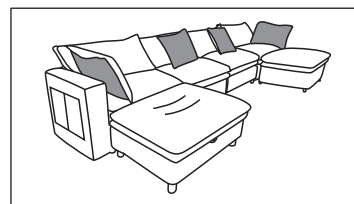

YOU CAN FREELY TRANSFORM AND COMBINE ACCORDING TO YOUR NEEDS

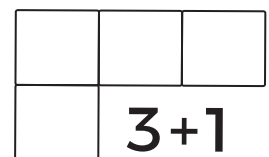
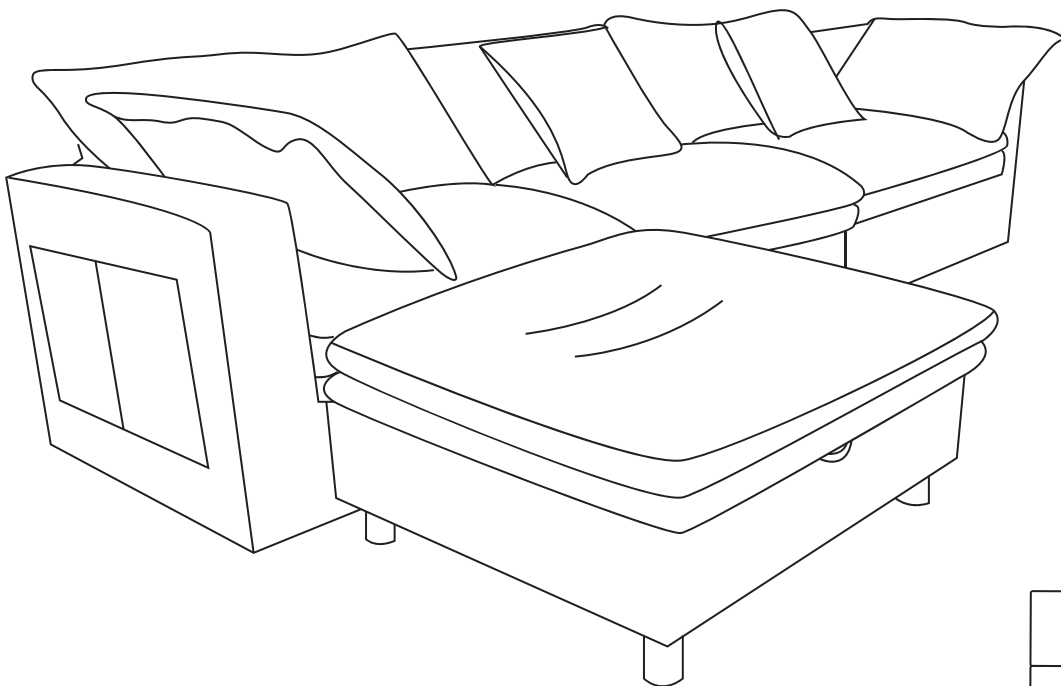
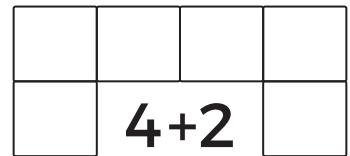
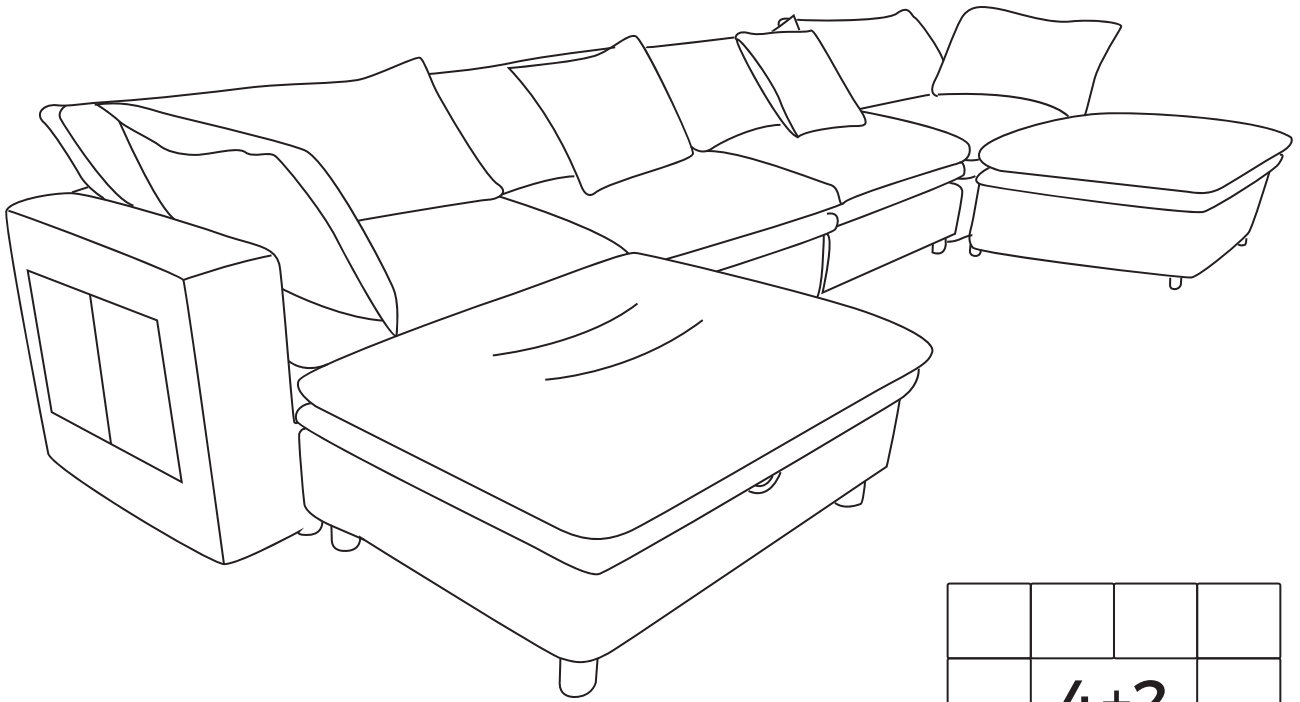

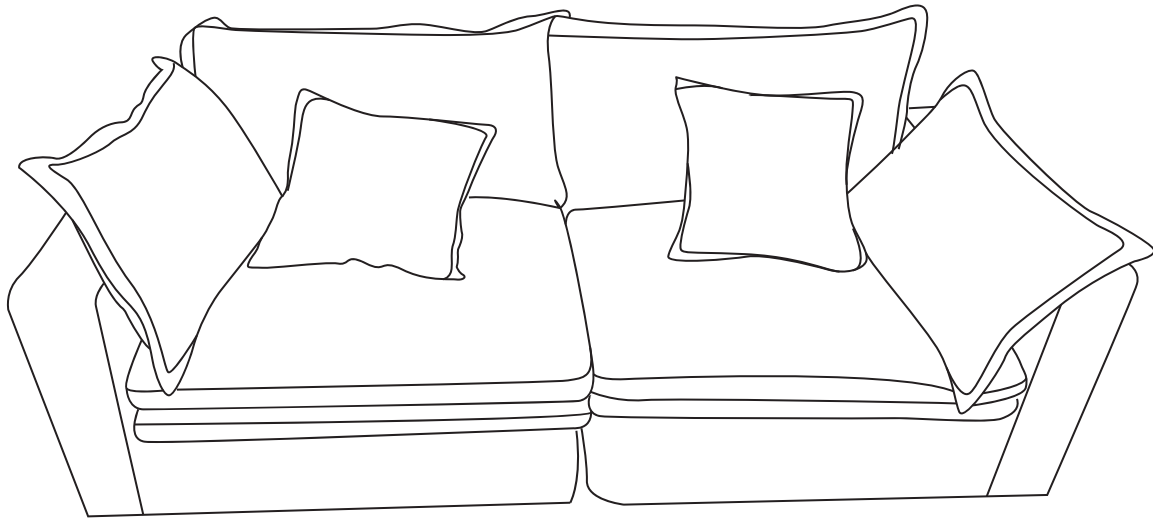

Loveseat

AFTER-SALES SERVICE

Thank you for choosing our product! We are committed to ensuring your satisfaction and providing excellent after-sales support. If you have any questions or concerns after receiving your order, please feel free to contact us. We are here to help!

What to Include in Your Message:

To help us resolve your issue as quickly as possible, please provide the following details:

1. Your order number.
2. A description of the issue or concern.
3. Any relevant photos or videos (if applicable).

Our customer support team will respond to your inquiry, and we will do our best to ensure a smooth and hassle-free experience.