

# NOTICE

- \* Please make sure that you have all parts indicated and are in good condition before you begin assembly of this item. Refer to part list and hardware list below for guidance .
- \* This item should be assembled on a soft surface to prevent scratching the finish during assembly.
- \* This item may require periodic tightening.
- \* If you are having difficulty, our friendly customer care team is always here to help . Please email [customersupport@safavieh.com](mailto:customersupport@safavieh.com)





# PREPARATION

- \* Before beginning assembly of product , make sure all parts are present . Compare parts with parts contents list and hardware contents list.
- \* If any part is missing or damaged, do not attempt to assemble the product.
- \* Estimated Assembly time : 10 minutes
- \* Tools Required for Assembly (included): Allen key

# CARE AND MAINTENANCE

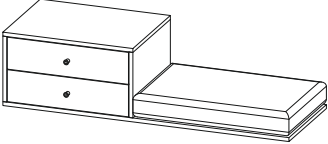
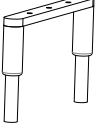
- \*Spot clean using a mild water-free solvent. Only a professional cleaner should undertake a complete overall cleaning.
- \*The use of steam or water-based cleaners may cause excessive shrinking or staining.

## Part List and Hardware List

PIECE	DESCRIPTION	PICTURE	QUANTITY
A	Cabinet		1X
B	Leg		2X
Hw1	Allen bolt 6 X 1 X 30 mm		6X
Hw2	Flat washer 25 x 8 mm		6X
Hw3	Allen key 4 mm		1X

Item#

Product dimensions: 43.3"L\* 15"W\*20.86"D

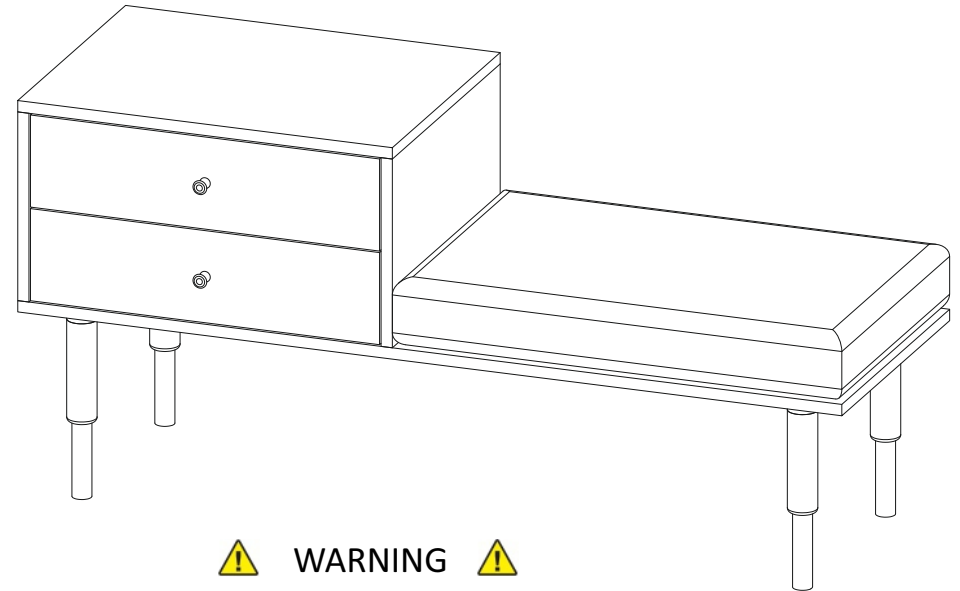

 **WARNING** 

Weight Capacity - 330 LBS

Warning : Do not stand on Bench

Warning : Do not over torque bolts.

# PREPARATION

\* Before beginning assembly of product , make sure all parts are present . Compare parts with parts contents list and hardware contents list.

\* If any part is missing or damaged, do not attempt to assemble the product.

\* Estimated Assembly time : 10 minutes

\* Tools Required for Assembly (included): Allen key

\* If you are having difficulty, our friendly Customer Care team is always here to help. Please email [customersupport@safavieh.com](mailto:customersupport@safavieh.com)

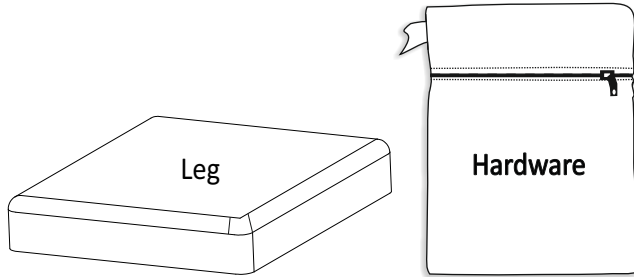

**STEP1** Unwrap the legs & take out legs.  
Open the hardware pouch & take out hardware.

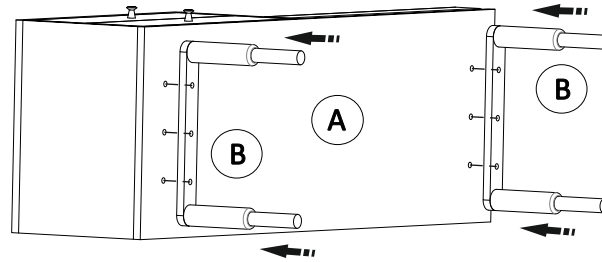

**STEP2** Place the bench upside down on a clean surface.  
Align legs on both sides of bench as per side holes present on either side of bench.

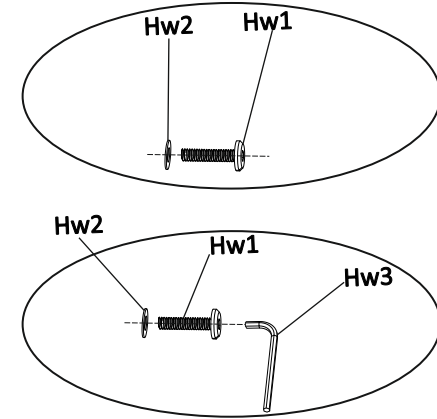

**STEP3** Put the washer on the Bolt in the order shown in picture.

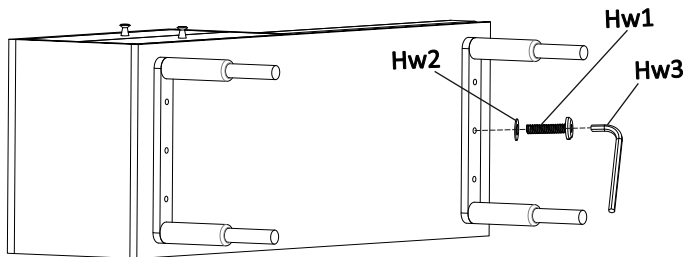

**STEP4** Insert Allen Bolt (Hw1) with Washer (Hw2) tighten with Allen Key (Hw3).Don't over tighten.

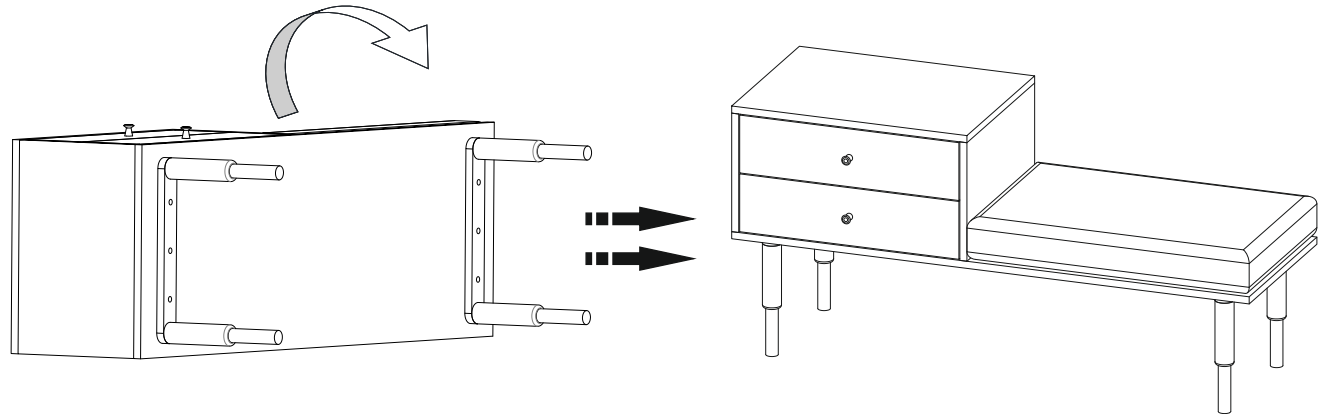

**STEP5** Repeat step 4 for, other side leg, flip the bench upright with help.