

Top View

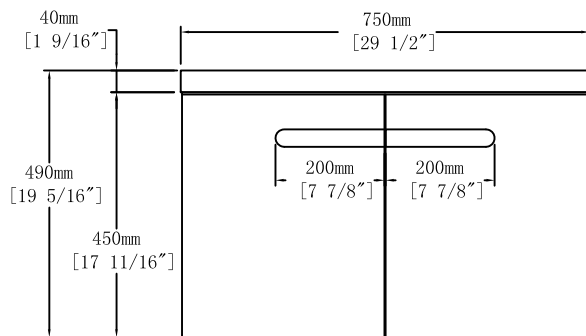

Front View

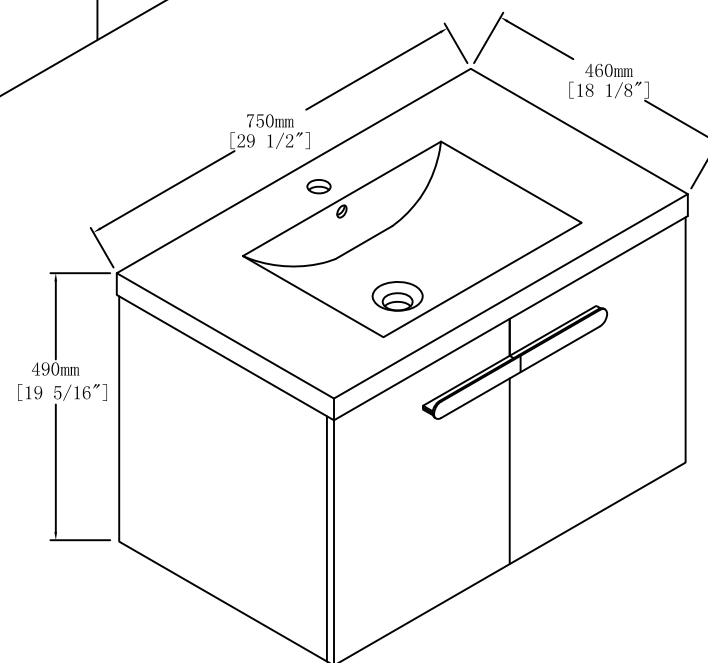
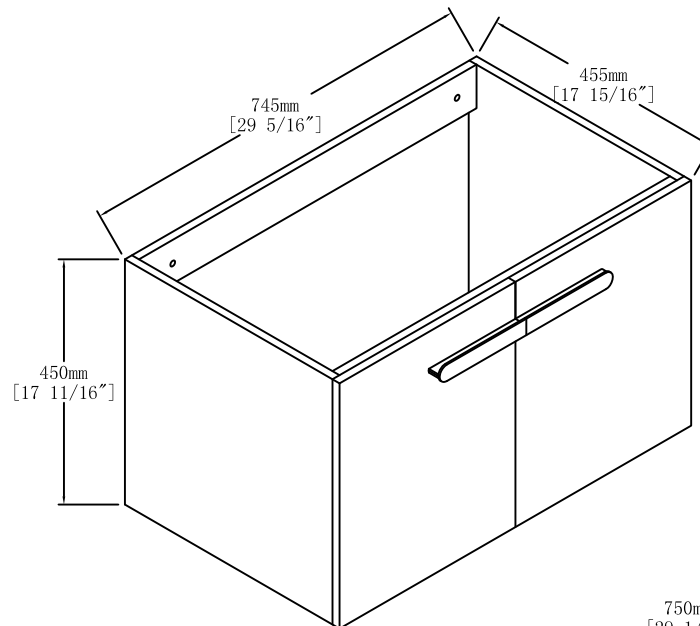
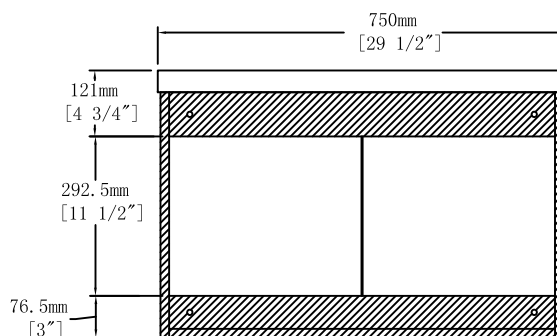

Back View



Item NO.

BV C09730

Version

V1

Project

Date

2024-4-23