

ASSEMBLY INSTRUCTIONS

Recliner

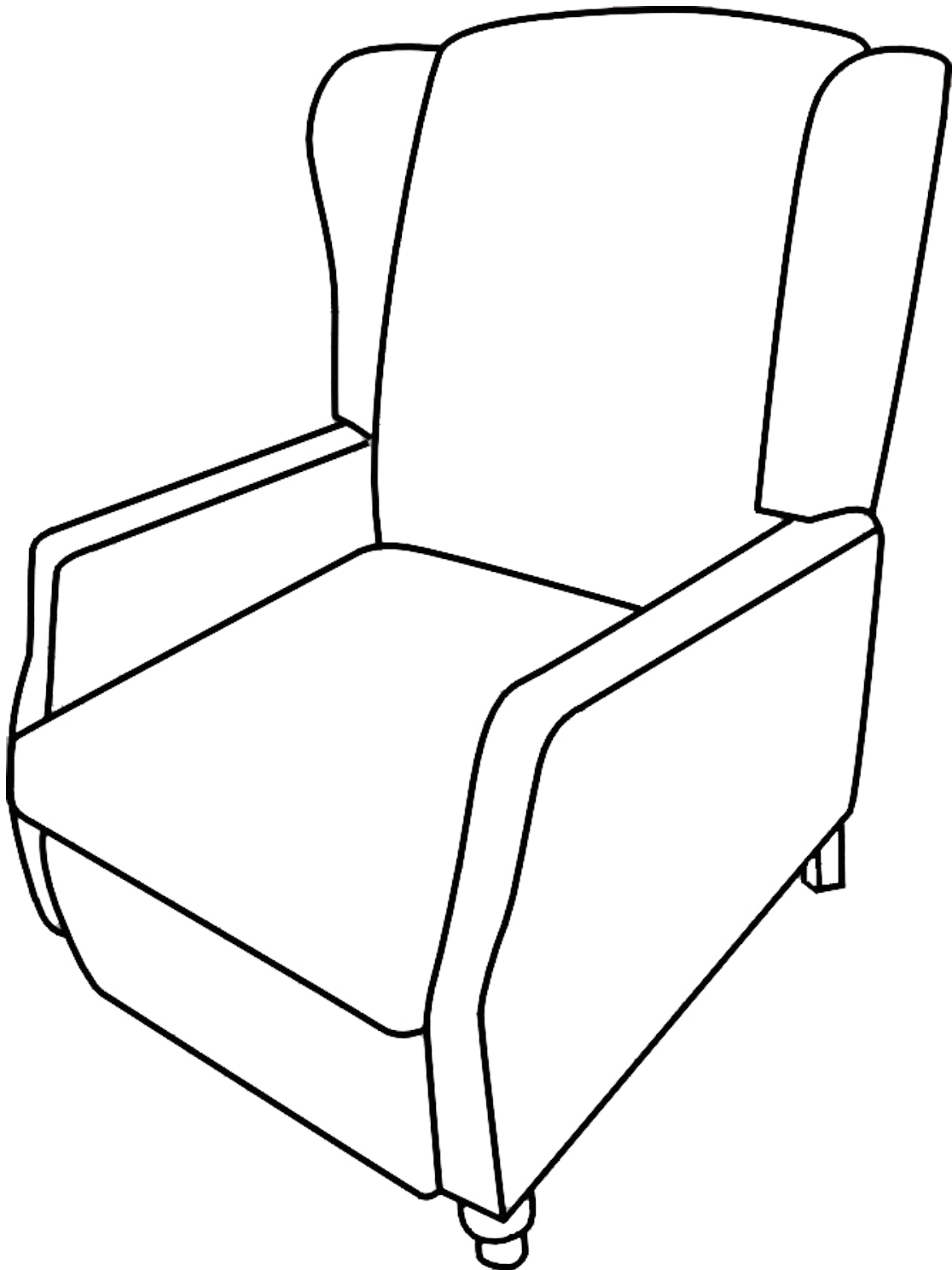

WARRANTY

So glad you have completed the assembly and can enjoy it. If you are satisfied with our products, thank you for showing your favored massage recliner to your around.

The quality of our furnitures has been strictly controlled. Each stage of the product upgrading has condensed the efforts of employees in various departments. We strive to minimize the probability of failure of new products and insist on providing customers with worthless after-sales service.

AFTER-SALE POLICY

For return reason:

Wrong purchase, bought by mistake, no longer needed, doesn't meet expectation, a size smaller than expectation, customer need to cover the return shipping fee.

For cancel order:

Customer needs to pay for shipping fee and carrier handle fee if the item has been shipped out.

For change address:

Customer needs to pay for extra shipping fee and carrier handle fee if the item has been shipped out.



Customer Service: Any problem with the product or shipping issue, please feel free to contact us, we will try our best to serve and help.

ATTENTION

Enjoyable time on recliner is coming after 15 minutes of installation!

- 1. Please check the manual carefully and make sure you have received all the parts.**
- 2. If there is any missing parts, please let us know the letter of the parts you need.**
- 3. If there is any damage parts, please send clear photos to us, we will check and offer you best solution soon.**

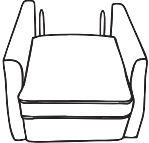
Accessory Part List

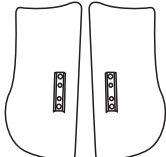
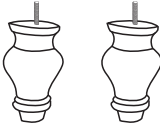
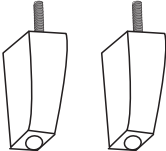
NO	PARTS	QTY
A	 Chair Base	1 PC
B	 Backrest	1 PC
C	 Left & Right Wing	2 PCS
D	 Front Leg	2 PCS
E	 Back Leg	2 PCS

Assembly Instruction

STEP 1

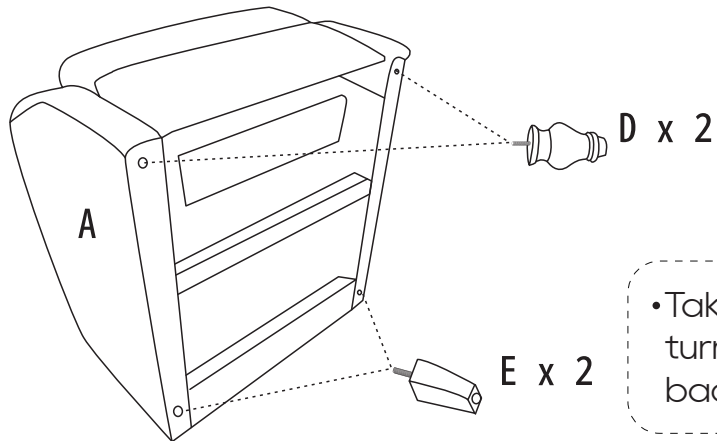

- Take the chair base from the box and turn over it, then screw the front and back legs into the chair base.

STEP 2

- Assemble backrest into the slots on the chair base.

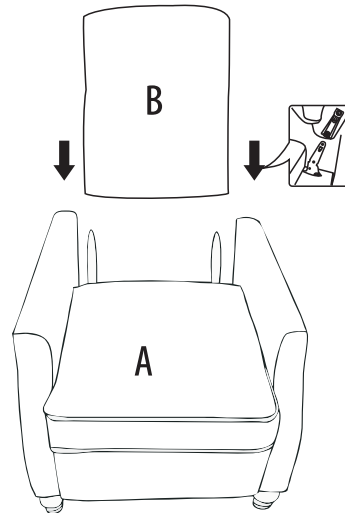

STEP 3

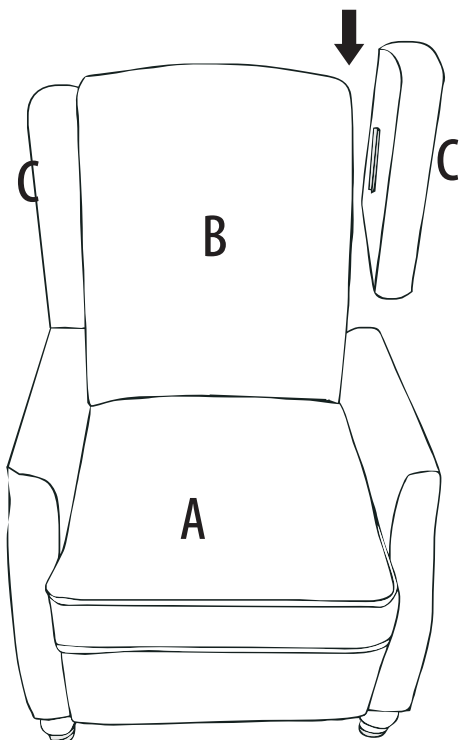

- Assemble left and right wings into the slots on the chair base.

Assembly Instruction

STEP 4

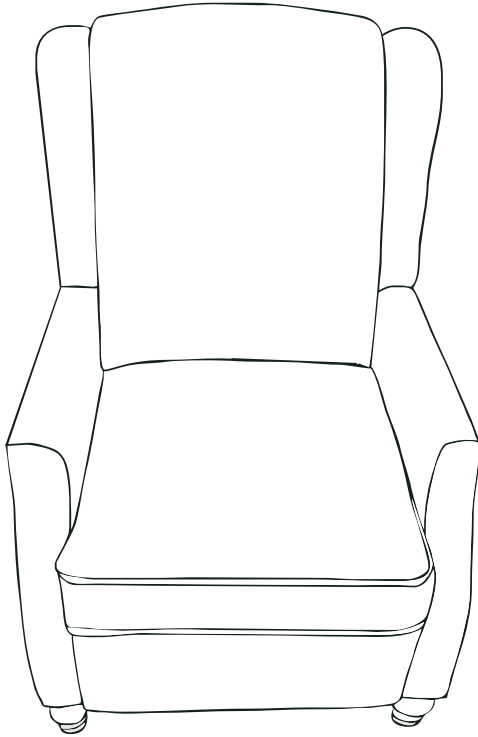

• Finished!

PUSH BACK

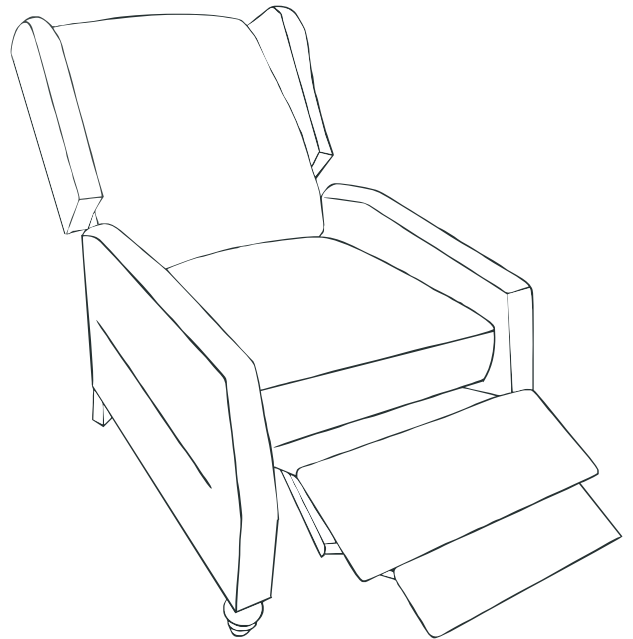

Do not smoke or play with fire

Warning

2-Person lift

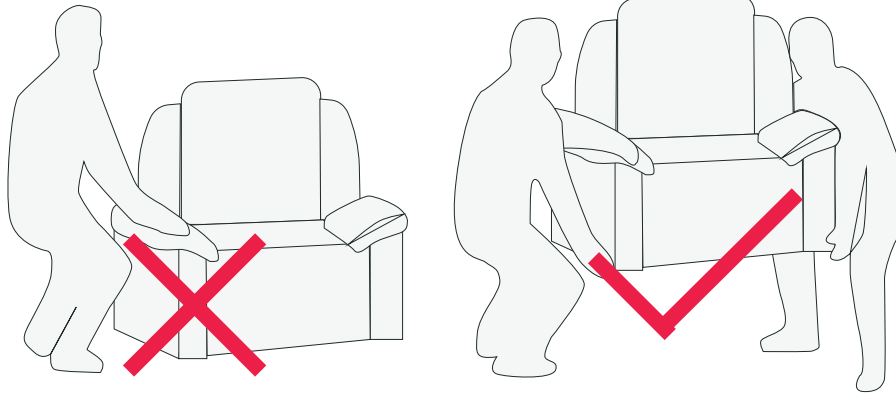

Do not move chair when it's reclining

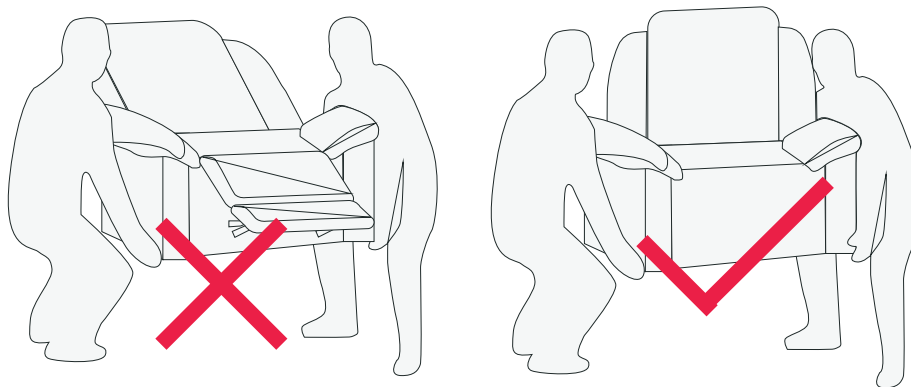

Do not sit/kick/stand on the footrest when the chair is on reclining position

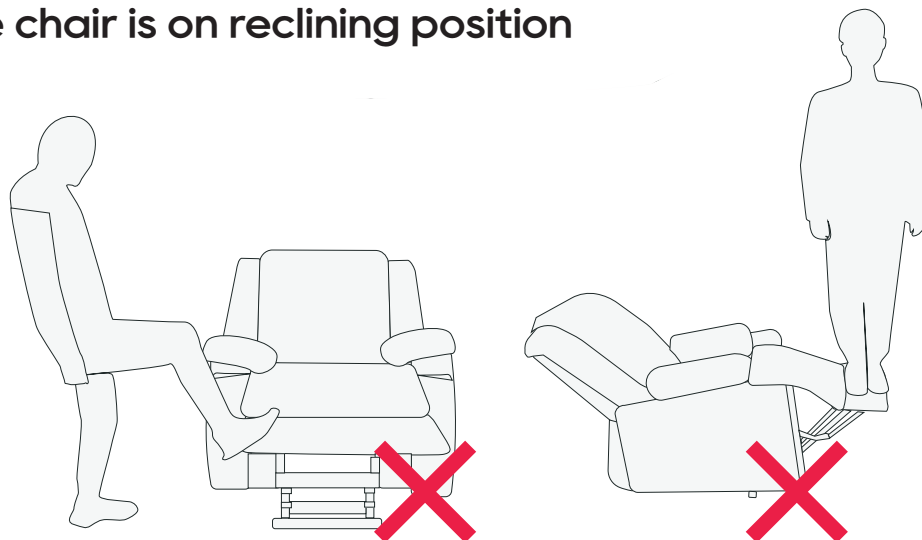

Warning

Do not stand up when the chair is on reclining position

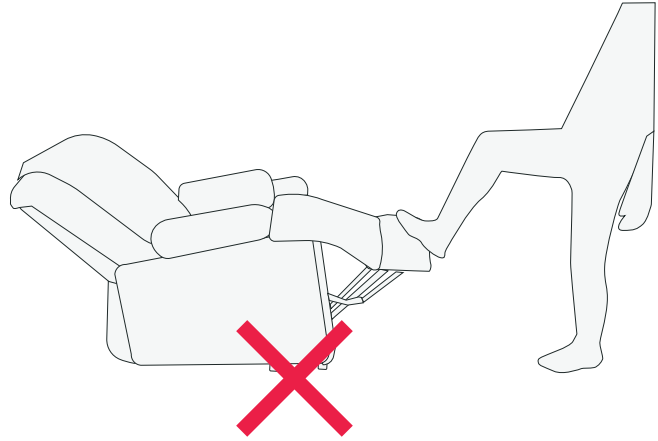
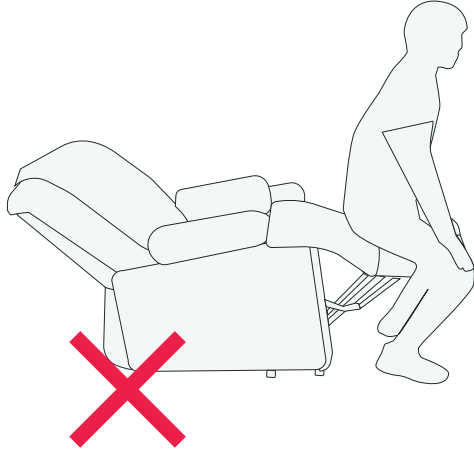

Leave enough space between chair back and wall before reclining

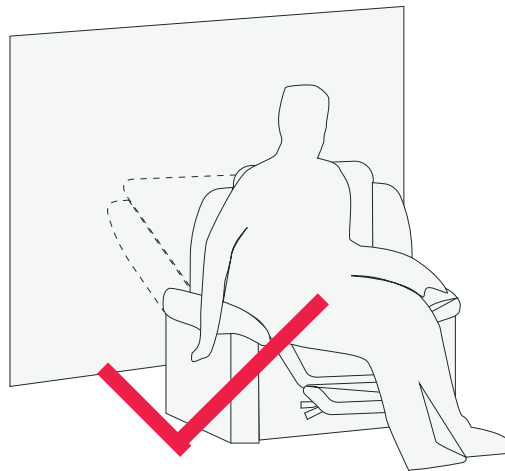
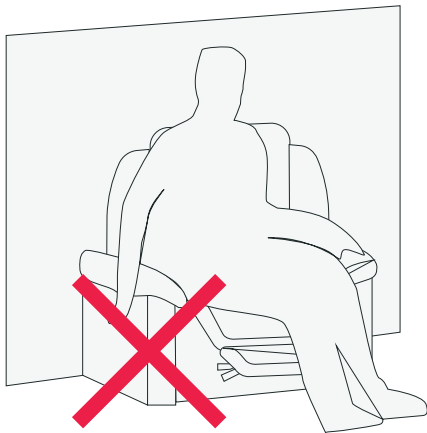

Do not sit on or press armrest

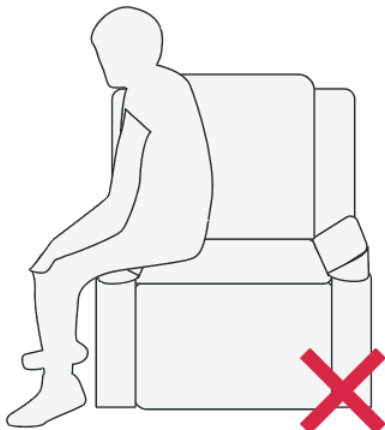

Do not press armrest after recline

