

ASSEMBLY INSTRUCTIONS

TWIN LOFT BED WITH DRAWER

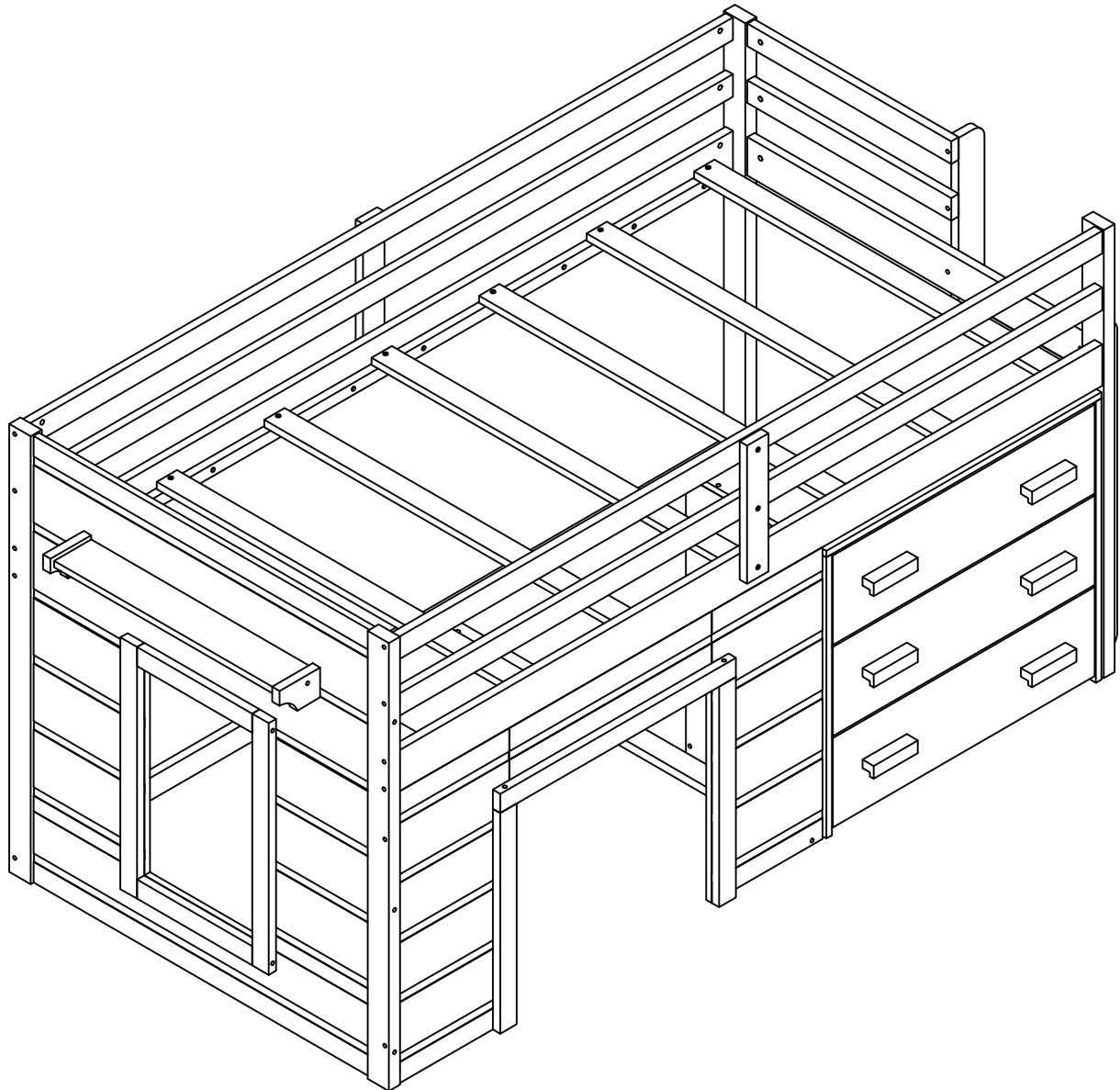

ASSEMBLY INSTRUCTIONS

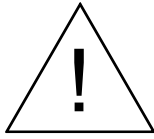

SAFETY WARNINGS



1. This bed is designed for use only mattress (es) meeting the following specifications on the upper bunk:
Upper bunk (bunk bed and tribed included)





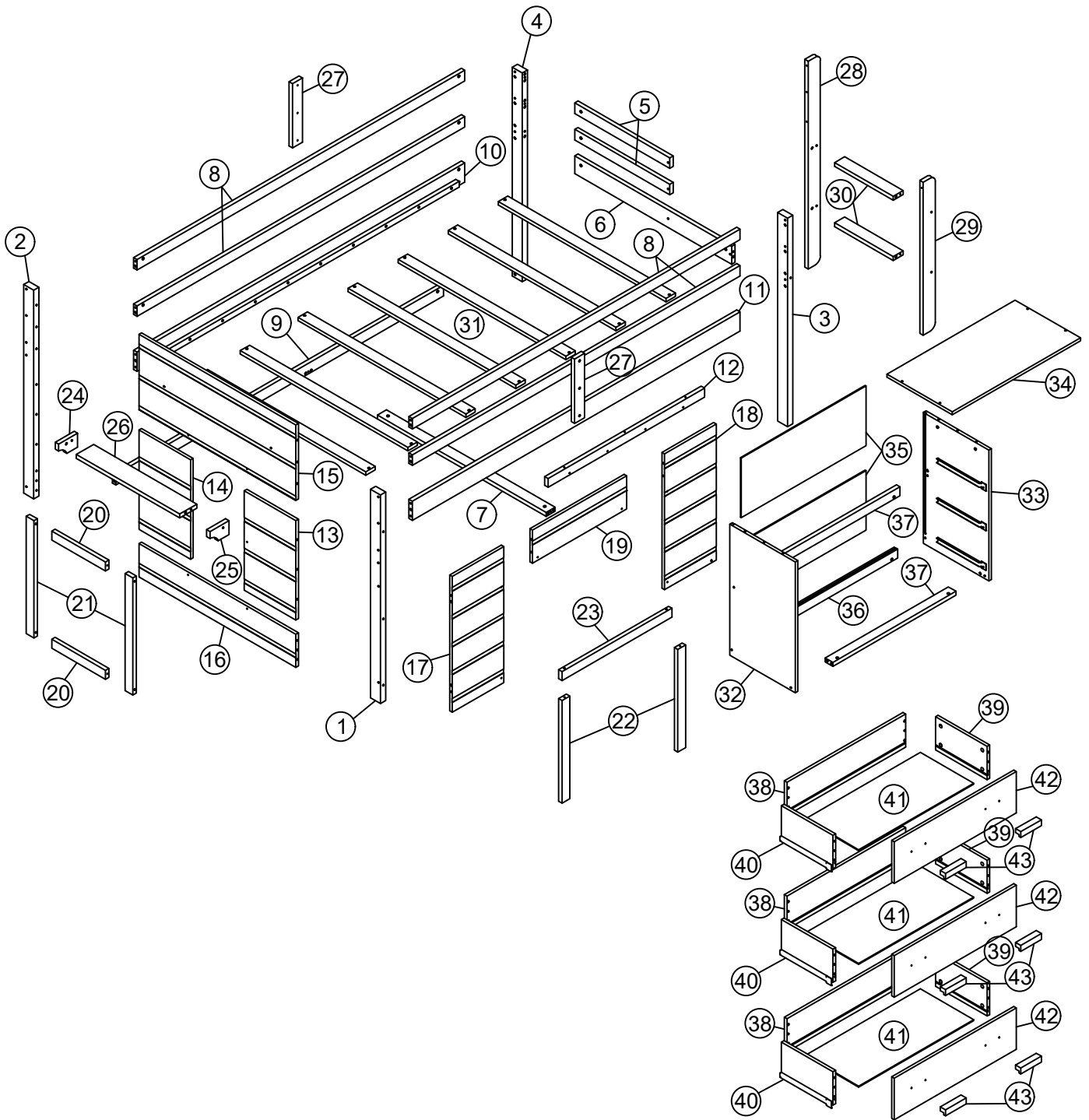





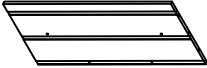
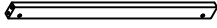
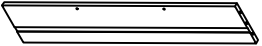
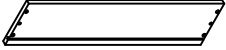
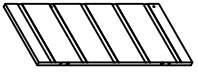
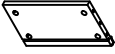

Bed Type	Length	Width	Thickness
Twin Standard	74" - 75"	37 $\frac{1}{2}$ " - 38 $\frac{1}{2}$ "	6" max
2. Replacement parts, including additional guardrails, maybe obtained from any of our dealers
3. Follow the information on the warnings appearing on the upper bunk bed end structure and on the carton. Do not remove warning label from bed.
4. Always use the recommended size mattresses or mattress supports, or both, to help prevent the likelihood of entrapment or falls.
5. Surface of mattress must be at least 5" (127mm) below the upper edge of guardrails.
6. Do not allow children under 6 years of age to use the upper bunk.
7. Periodically check and ensure that the guardrail, ladder, and other components are in their proper position, free from damage, and that all connectors are tight.
8. Do not allow horseplay on or under the bed and prohibit jumping on the bed.
9. Always use the ladder for entering and leaving the upper bunk.
10. Do not use substitute part. Contact the manufacture or dealer for replacement part.
11. Use of a night light may provide added safety precaution for a child using the upper bunk.
12. Always use guardrails on both long sides of the upper bunk. If the bunk bed will be placed next to the wall, the guardrail that runs the full length of the bed should be placed against the wall to prevent entrapment between the bed and wall.
13. The use of water or sleep flotation mattresses is prohibited.
14. **STRANGULATION HAZARD** - Never attach or hang items to any part of the bunk bed that are not designed for use with the bed; for example, but not limited to, hook, belts and jump ropes.
15. Keep these instruction for future reference.
16. Prohibit more than one person on upper bunk
17. We recommend assembling your bunk bed on the shipping carton to protect your floor or carpet.
18. Be certain all staples are out of the box before beginning assembly on the shipping carton.

ASSEMBLY INSTRUCTIONS



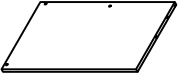
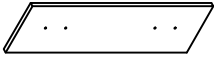









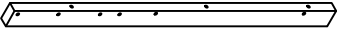

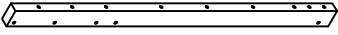
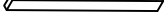
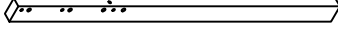
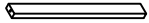
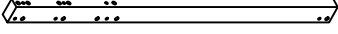
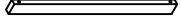
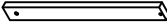

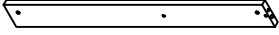
ASSEMBLY INSTRUCTIONS

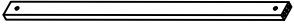
PARTS LIST

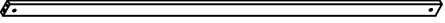

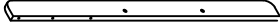



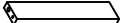
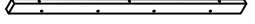
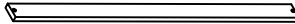



13	Right head board frames 	1pc	35	Board drawers 	2pcs
14	Left head board frames 	1pc	36	Frame back lower support bar 	1pc
15	Upper head board frames 	1pc	37	Frame support bar 	2pcs
16	Lower head board frames 	1pc	38	Drawer back panels 	3pcs
17	Front - left board frames 	1pc	39	Drawer side right panels 	3pcs
18	Front - right board frames 	1pc	40	Drawer side left panels 	3pcs
19	Front - upper board frames 	1pc	41	Drawer bottom panels 	3pcs
32	Left - board drawers 	1pc	42	Drawer front panels 	3pcs
33	Right - board drawers 	1pc	43	Drawer handle 	6pcs
34	Top - board drawers 	1pc			

ASSEMBLY INSTRUCTIONS

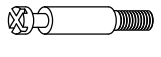
PARTS LIST

1	 Left front leg	1pc	20	 Window frame	2pcs
2	 Left back leg	1pc	21	 Window frame	2pcs
3	 Right front leg	1pc	22	 Door frame	2pcs
4	 Right back leg	1pc	23	 Door frame	1pc
5	 Short head board panels	2pcs	24	 Left window bar	1pc
6	 Long head board panels	1pc	25	 Right window bar	1pc
7	 Bottom board panel	1pc	26	 Window bar	1pc
8	 Front - back guard rails	4pcs	27	 Front - back guard rails supports	2pcs
9	 Bottom back guard rails	1pc	28	 Right stair side or left stair side	1pc
10	 Back side rails	1pc	29	 Left stair side or left stair side	1pc
11	 Front side rails	1pc	30	 Step stair side	2pcs
12	 Support panel	1pc	31	 Slats	7pcs

HARDWARE LIST



A	1/4x110 	10PCS	I	Ø8x30 	32PCS
B	1/4x75 	20PCS	M	Ø4x30 	48PCS
C	1/4x65 	14PCS	L	Ø 6.5x35 	24PCS
D	6.5x60 	13PCS	K	Ø15x12 	24PCS
E	6.5x90 	6PCS	J	4x58 	1PC
H	Ø10x40 	36PCS			

ASSEMBLY INSTRUCTIONS

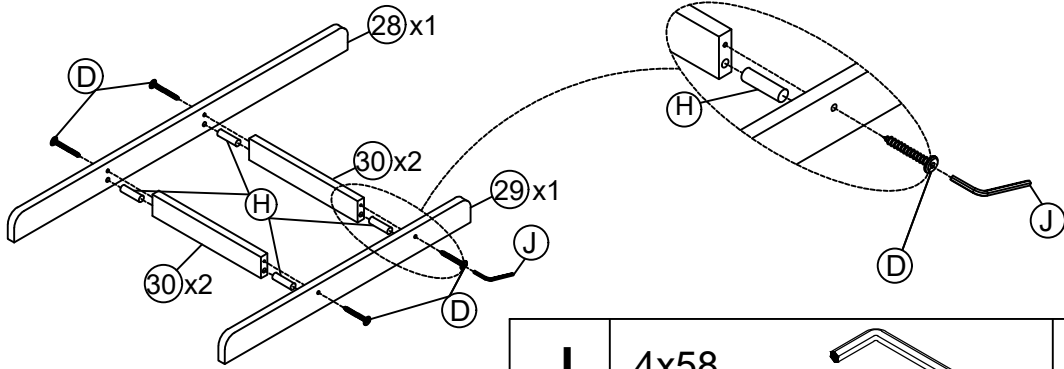
Step 1





J	4x58		1PC
----------	------	---	-----

H	Ø10x40		4PCS	D	6.5x60		4PCS
----------	--------	---	------	----------	--------	---	------

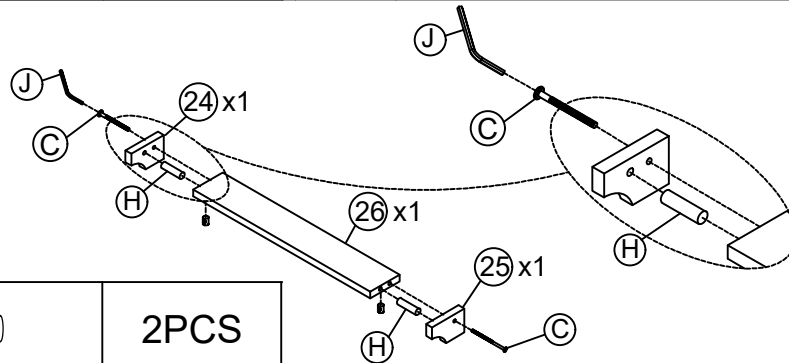
Step 2





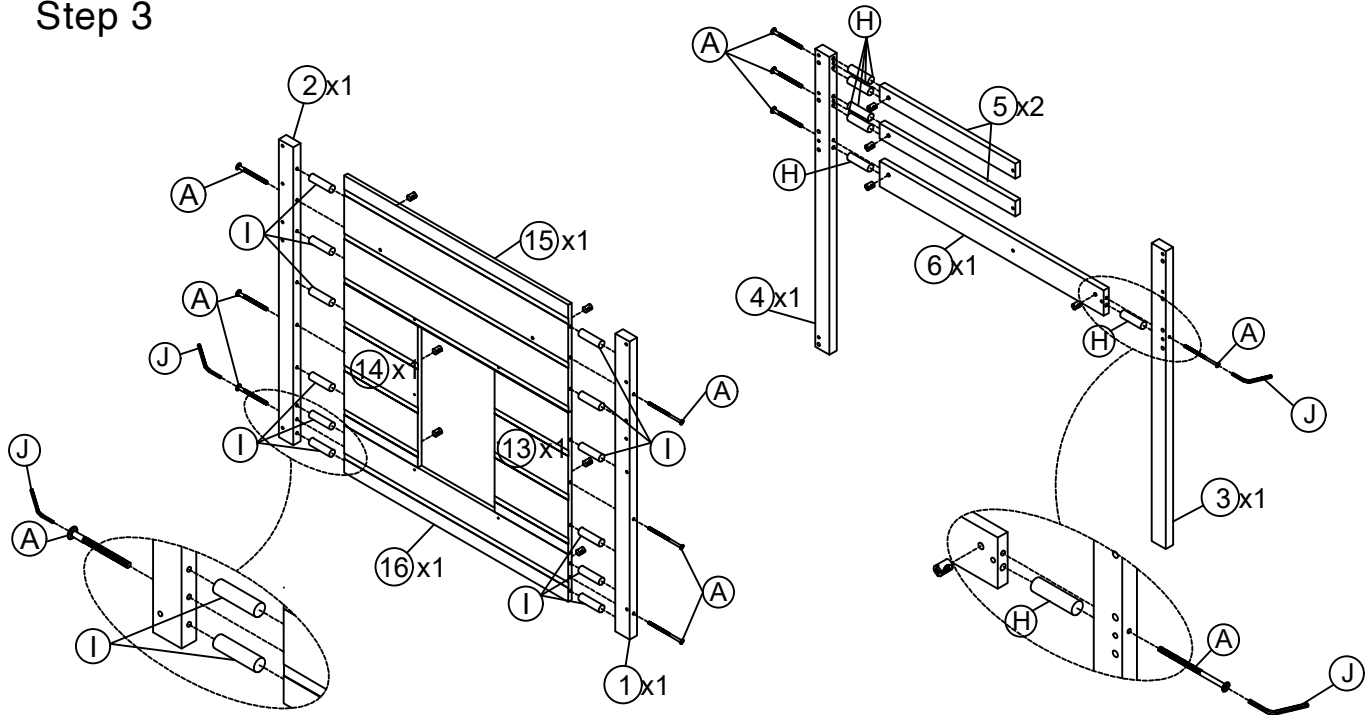

H	Ø10x40		2PCS
----------	--------	--	------

C	1/4x65		2PCS	J	4x58		1PC
----------	--------	---	------	----------	------	---	-----

Step 3







A	1/4x110		10PCS	H	Ø10x40		6PCS
----------	---------	---	-------	----------	--------	---	------

J	4x58		1PC	I	Ø8x30		12PCS
----------	------	---	-----	----------	-------	---	-------

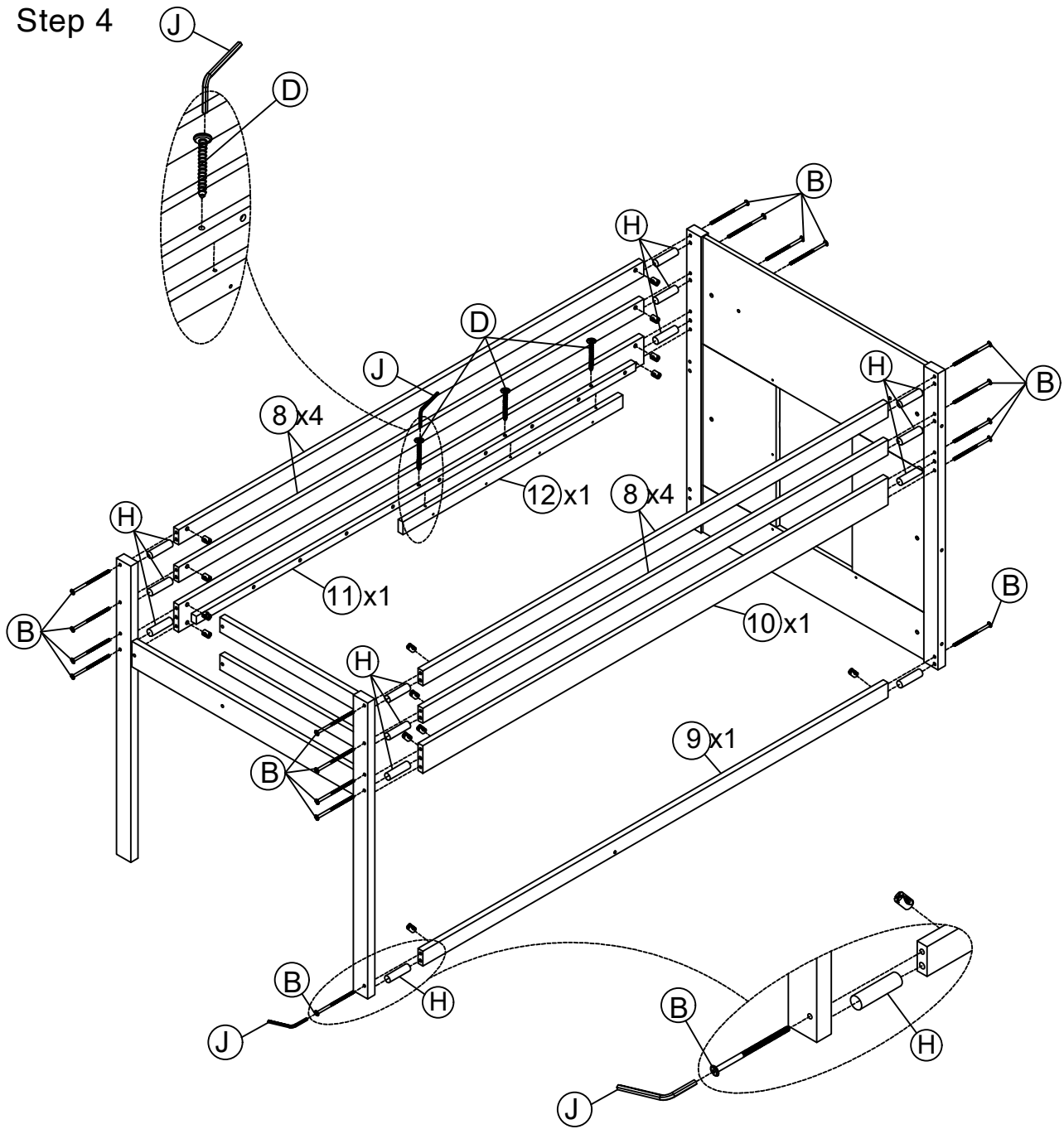
ASSEMBLY INSTRUCTIONS

Step 4





B	1/4x75		18PCS	D	6.5x60		3PCS
J	4x58		1PC	H	Ø10x40		14PCS

ASSEMBLY INSTRUCTIONS

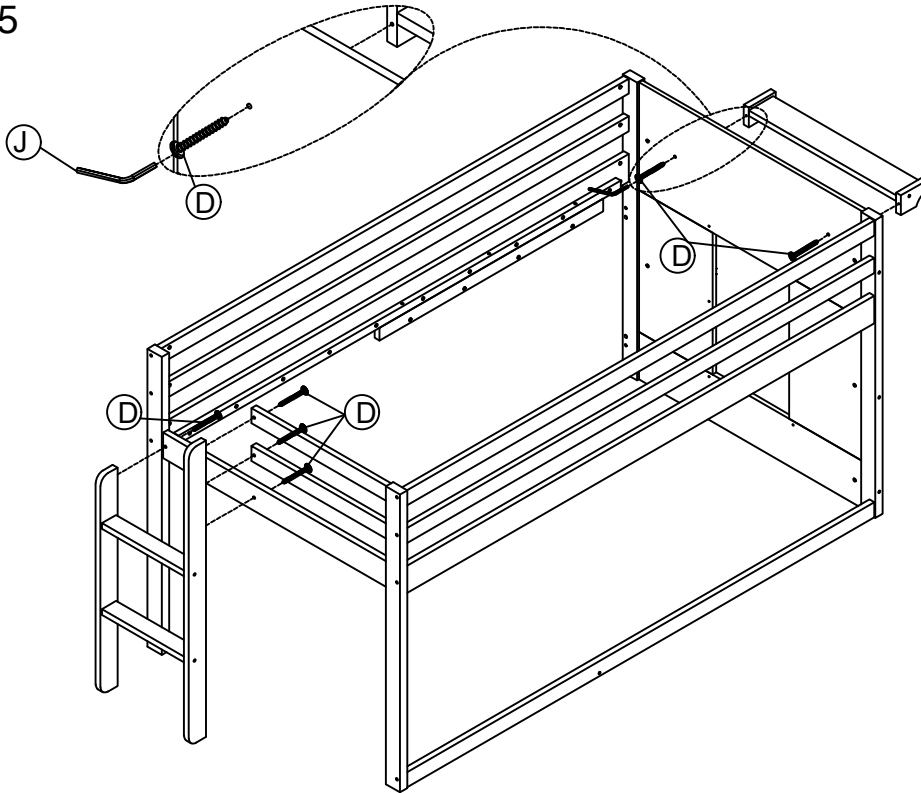

Step 5

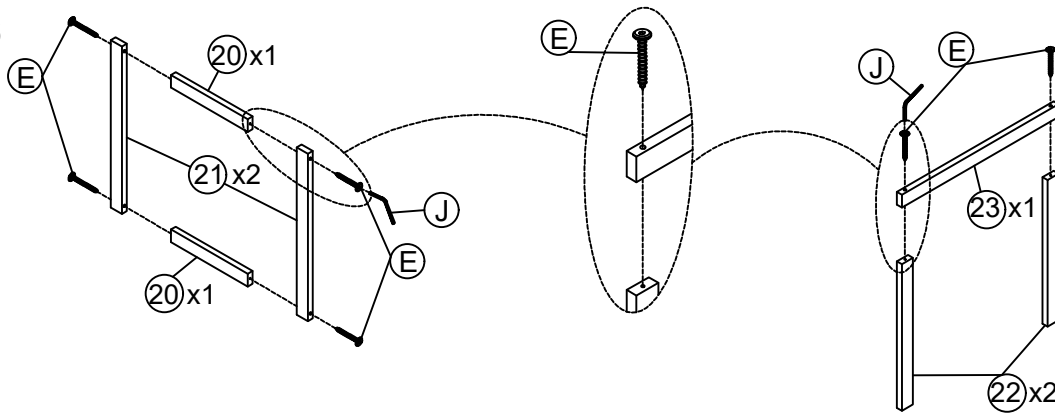

D	6.5x60		6PCS	J	4x58		1PC
----------	--------	---	------	----------	------	---	-----

Step 6



E	6.5x90		6PCS	J	4x58		1PC
----------	--------	---	------	----------	------	---	-----

Step 7

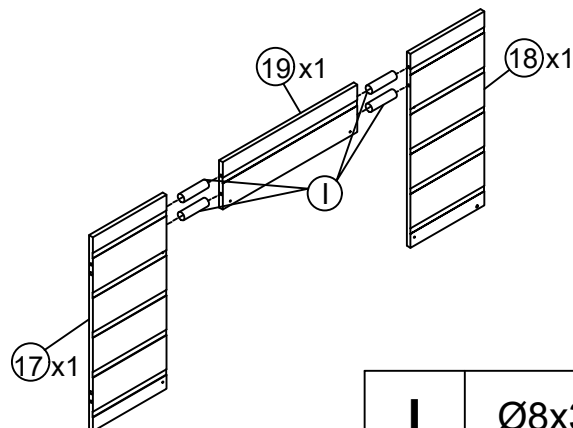



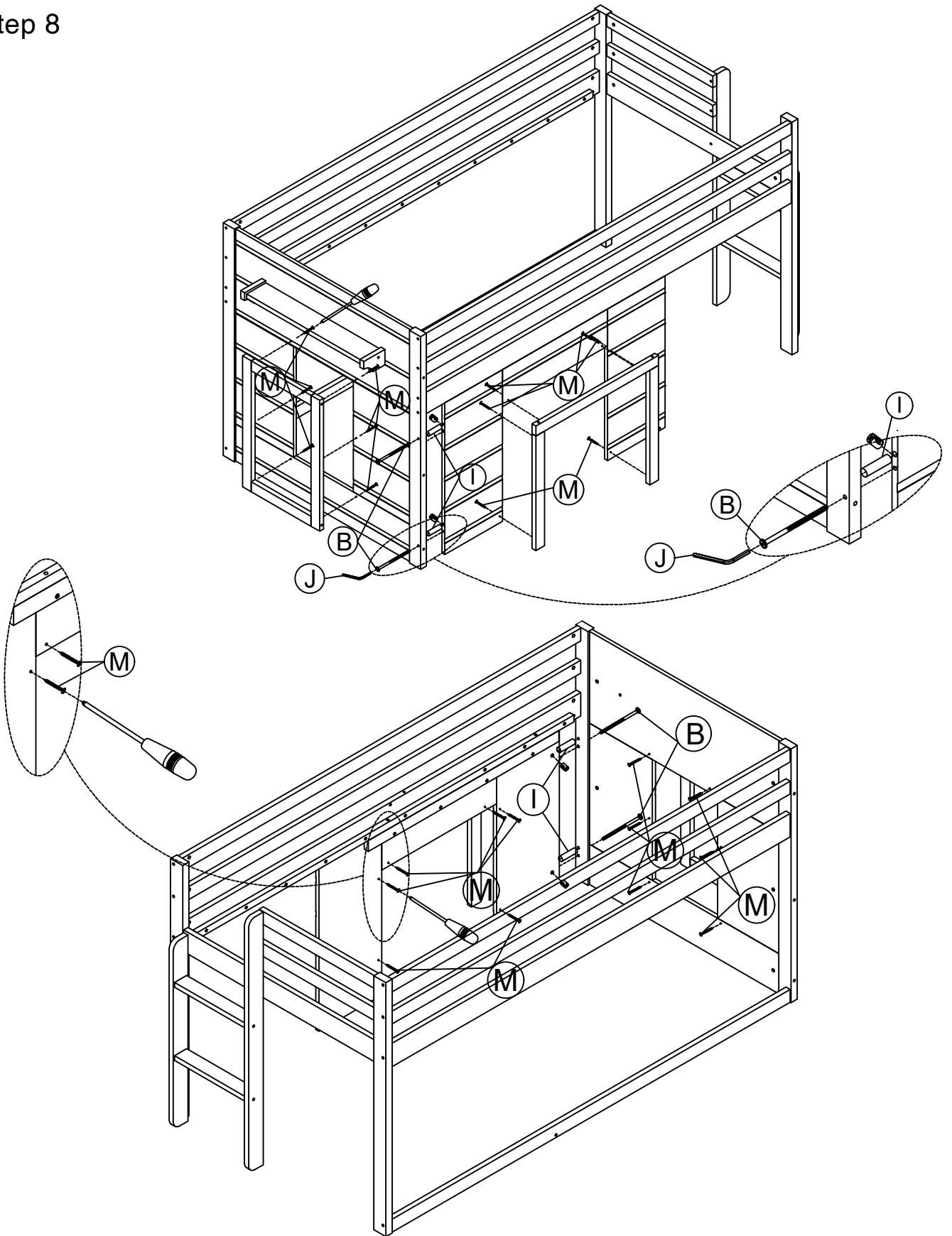

I	Ø8x30		4PCS
----------	-------	---	------

ASSEMBLY INSTRUCTIONS

Step 8



B	1/4x75		2PCS	M	Ø4x30		12PCS
J	4x58		1PC	I	Ø8x30		2PCS

ASSEMBLY INSTRUCTIONS

Step 9

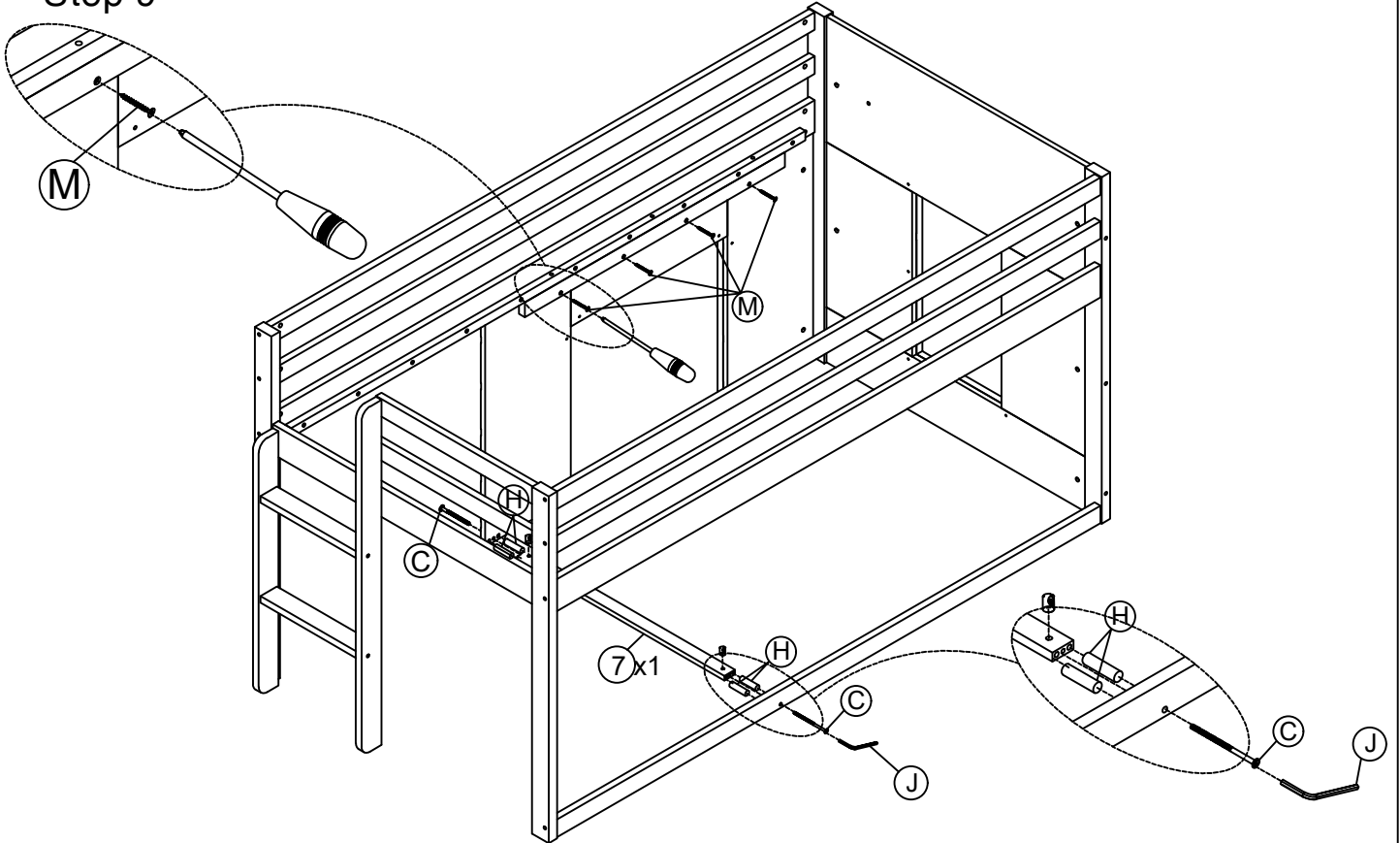

H	Ø10x40		4PCS	M	Ø4x30		4PCS
C	1/4x65		2PCS	J	4x58		1PC

Step 10

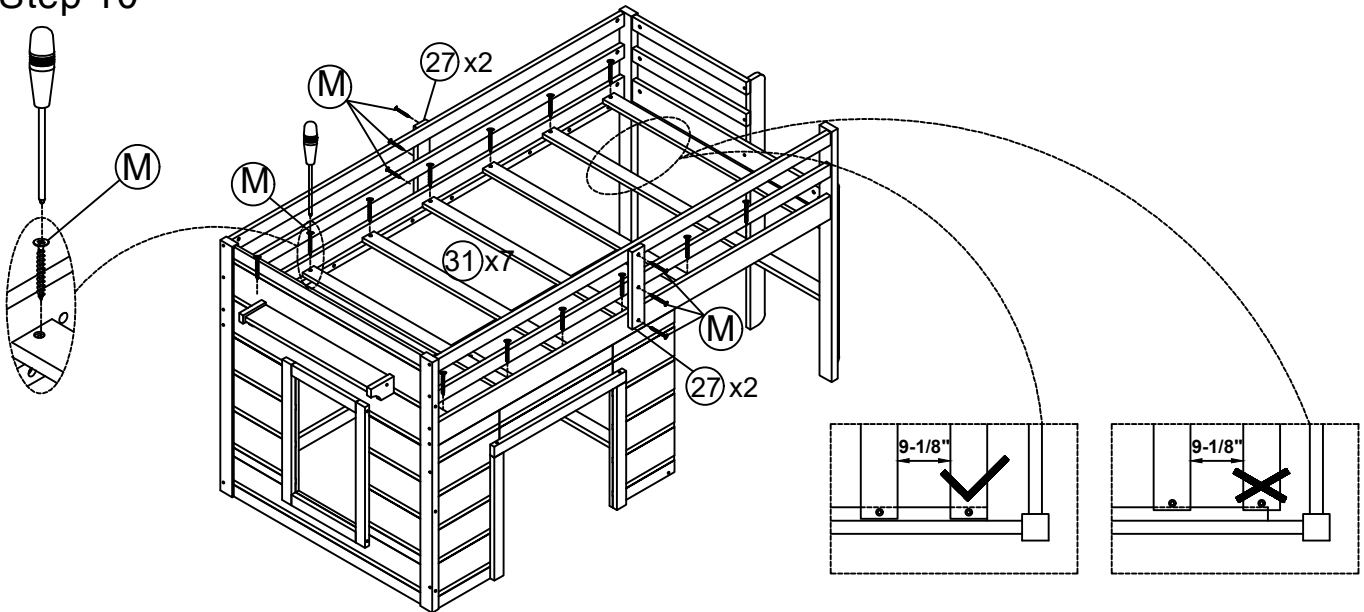





Note: First attach 2pcs part 31 to the front and end of the frame between headboard. Then attach the remaining part 31 equidistantly between headboard

M	Ø4x30		20PCS
----------	-------	--	-------

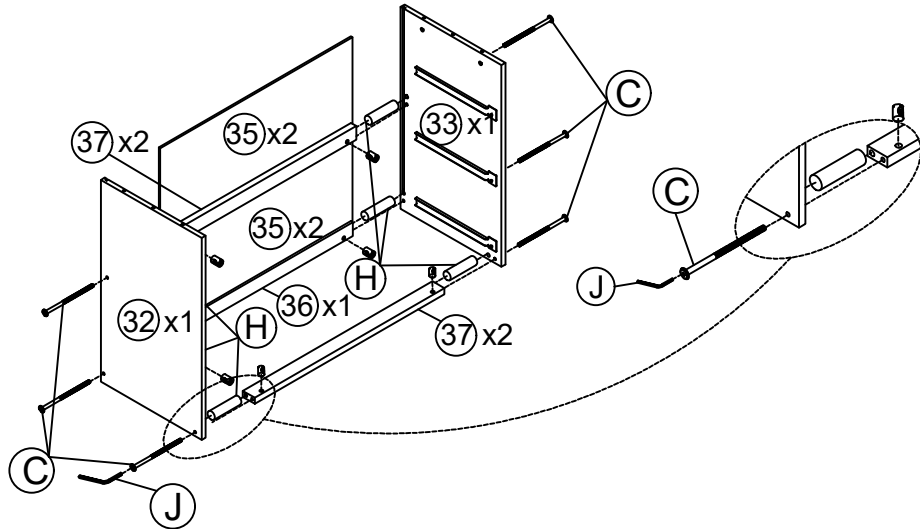
ASSEMBLY INSTRUCTIONS



Step 11

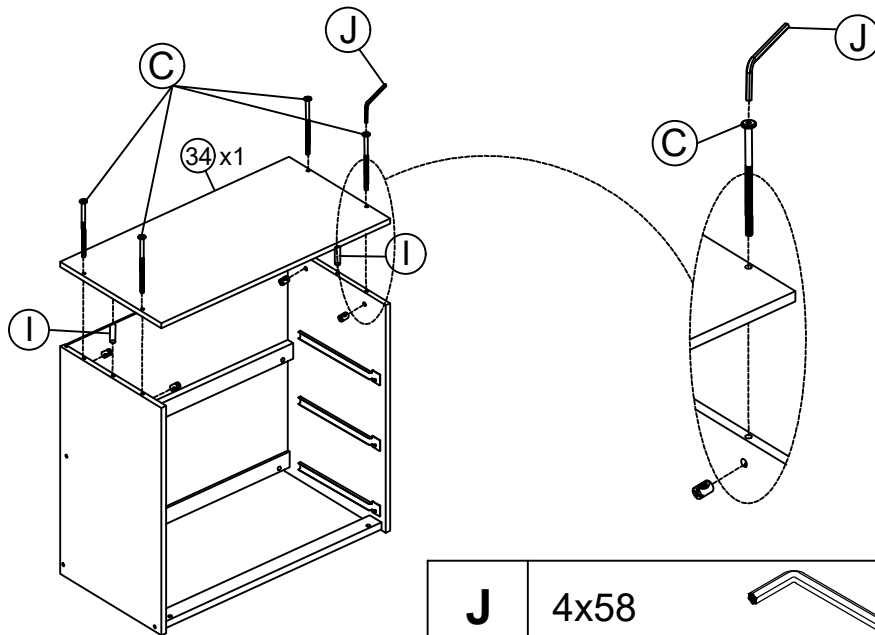

H	Ø10x40		6PCS				
C	1/4x65		6PCS	J	4x58		1PC

Step 12



				J	4x58		1PC
I	Ø8x30		2PCS	C	1/4x65		4PCS

Step 13

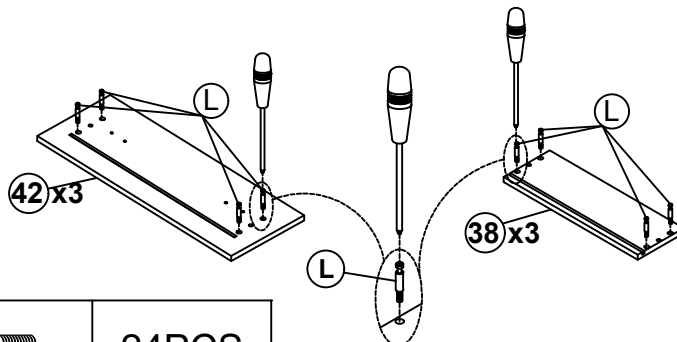

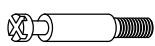
L	Ø 6.5x35		24PCS
----------	----------	---	-------

ASSEMBLY INSTRUCTIONS

Step 14

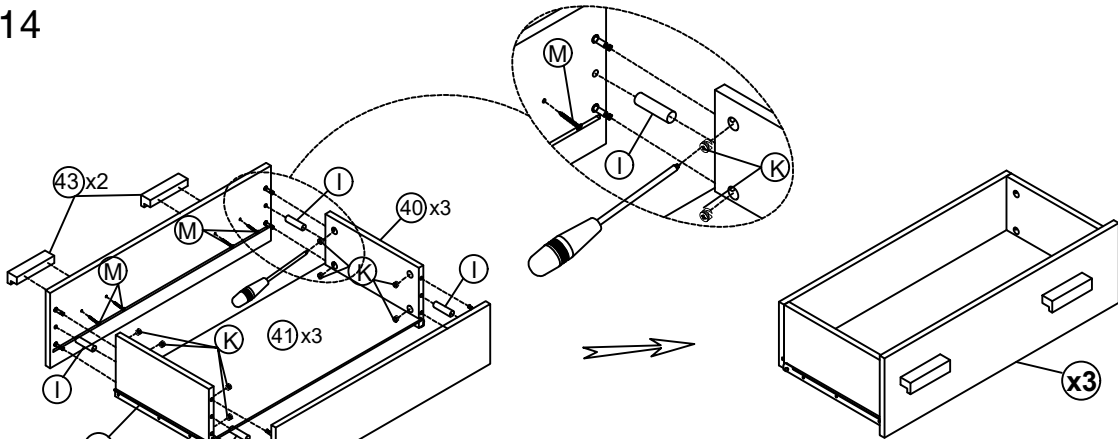

M	Ø4x30		12PCS
----------	-------	---	-------

K	Ø15x12		24PCS
----------	--------	---	-------

I	Ø8x30		12PCS
----------	-------	---	-------

Step 15

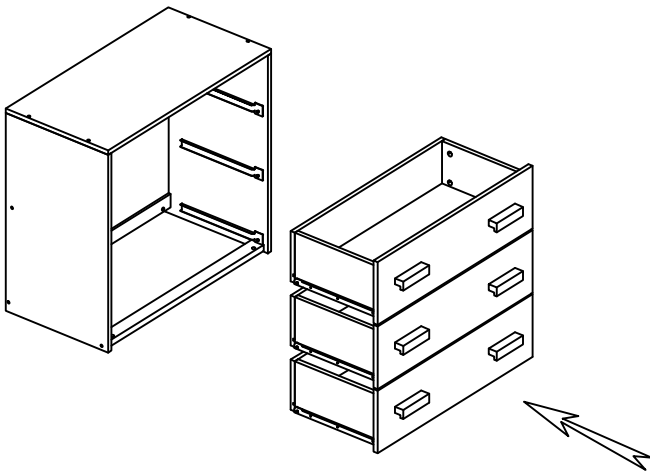

Step 16

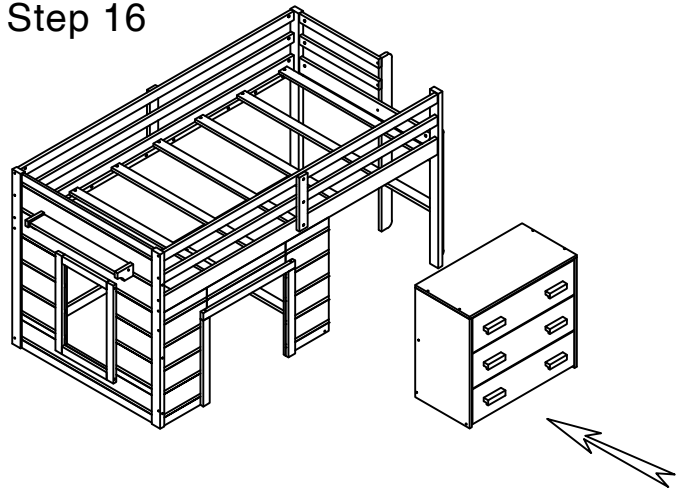

Step 17

