

# ASSEMBLY INSTRUCTIONS

## I DESCRIPTION: SECTIONAL

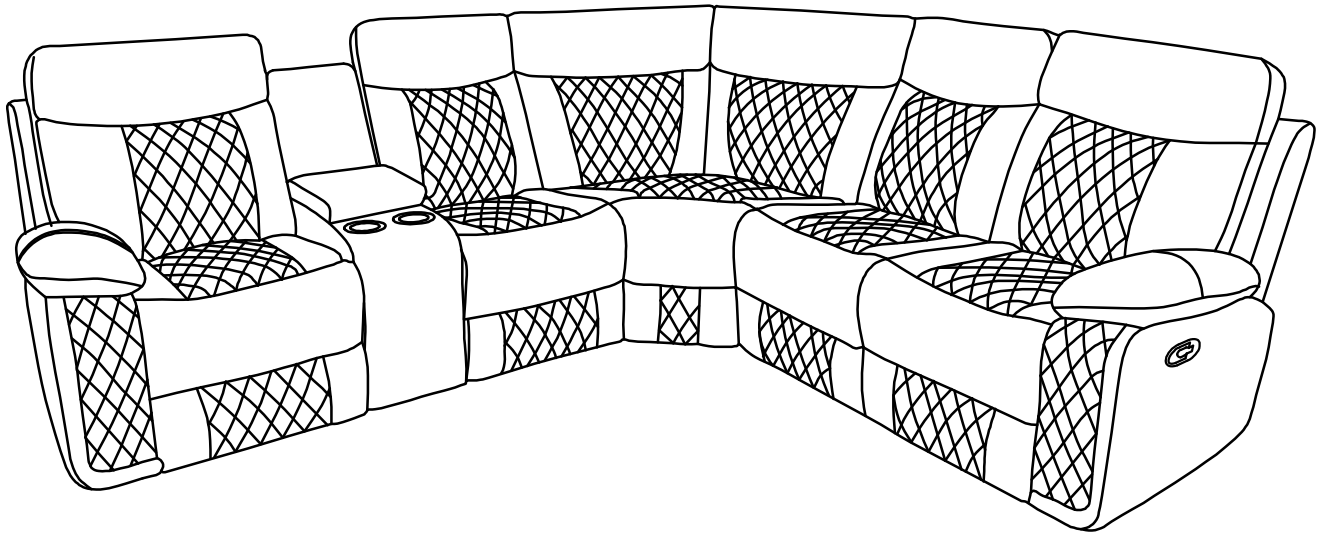

# ASSEMBLY INSTRUCTIONS

DESCRIPTION: SECTIONAL

## PARTS AND HARDWARE

Avoid using sharp objects such as a knife to cut open packing as you may accidentally damage the upholstery.

A\*1

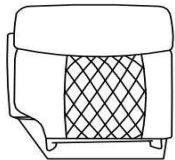

Left Back Cushion

B\*1

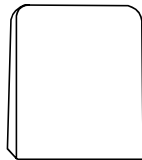

Left Console Back

C\*1

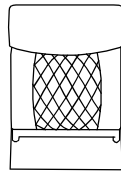

Armless Back Cushion

E\*1



Left Arm

H\*1

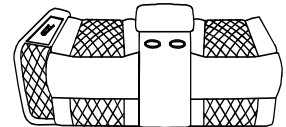

Left Seat Base

D\*2

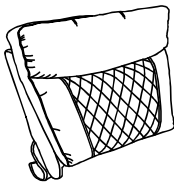

Corner Back Cushion

I\*1

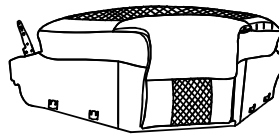

Wedge Seat Base

C\*1

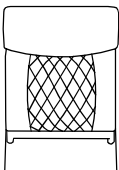

Armless Back Cushion

F\*1



Right Arm

G\*1

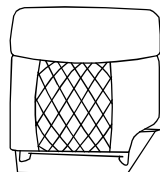

Right Back Cushion

J\*1

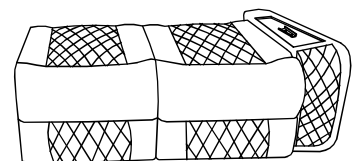

Right Seat Base

# ASSEMBLY INSTRUCTIONS

## DESCRIPTION: SECTIONAL

CAUTION: At least two adults are required to safely complete performing this task.  
Other lifting attempts may risk back injury due to large and heavy part(s).



- 1 Carefully unpack and place parts on a clean flat surface.
- 2 Insert the female brackets at the Left Arm (E) onto the male brackets at the Left seat base (H), insert the female brackets at the Right Arm (F) onto the male brackets at the Right seat base (H), insert and push to the end, make sure the brackets are secured in position.

**Remark: Take out the console back (B) from the bottom of part (I).**

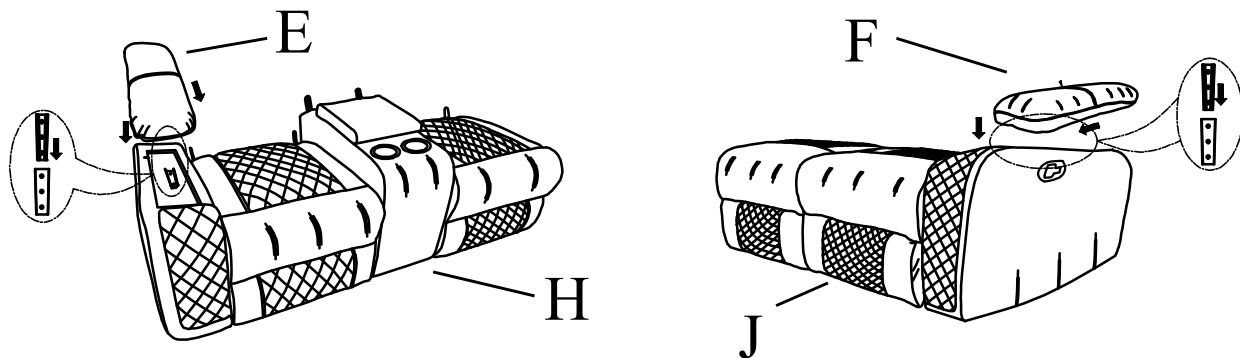
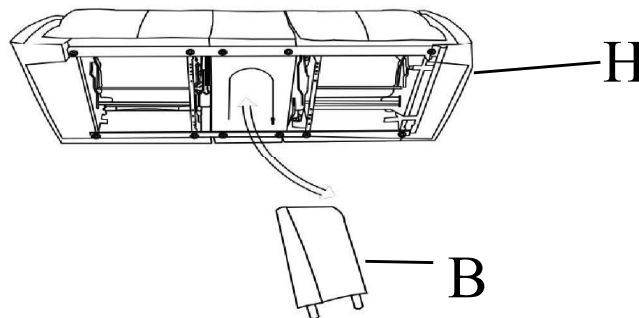

- 3 Attach the Left Seat Base (H) & Right Seat Base (J) to the Wedge Seat Base (I), ensuring it is correctly in place.

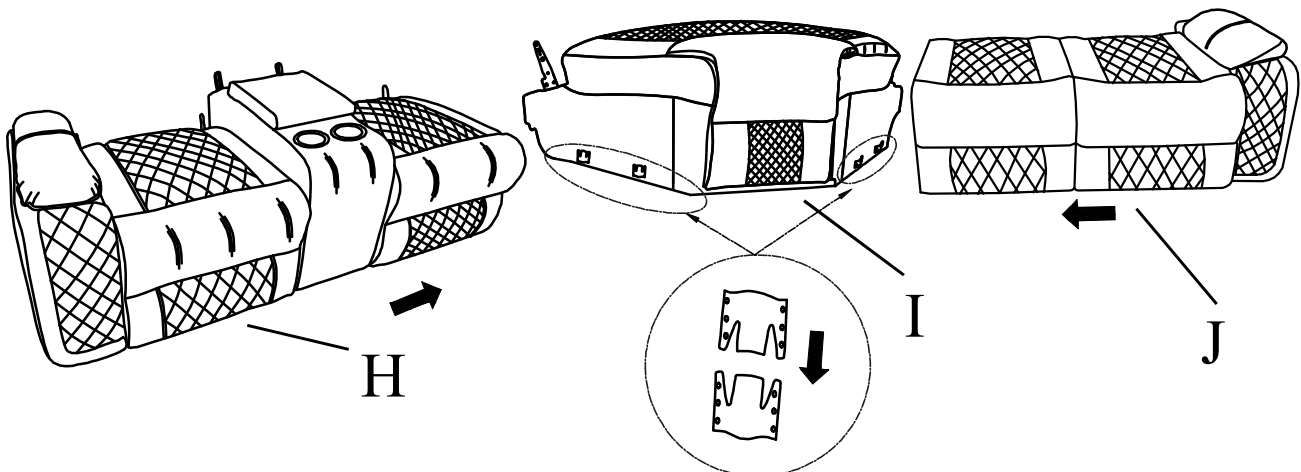

# ASSEMBLY INSTRUCTIONS

## DESCRIPTION: SECTIONAL

CAUTION: At least two adults are required to safely complete performing this task.  
Other lifting attempts may risk back injury due to large and heavy part(s).



- 4** Attach the Backrests to the Seat Bases  
Ensure it is correctly in place.

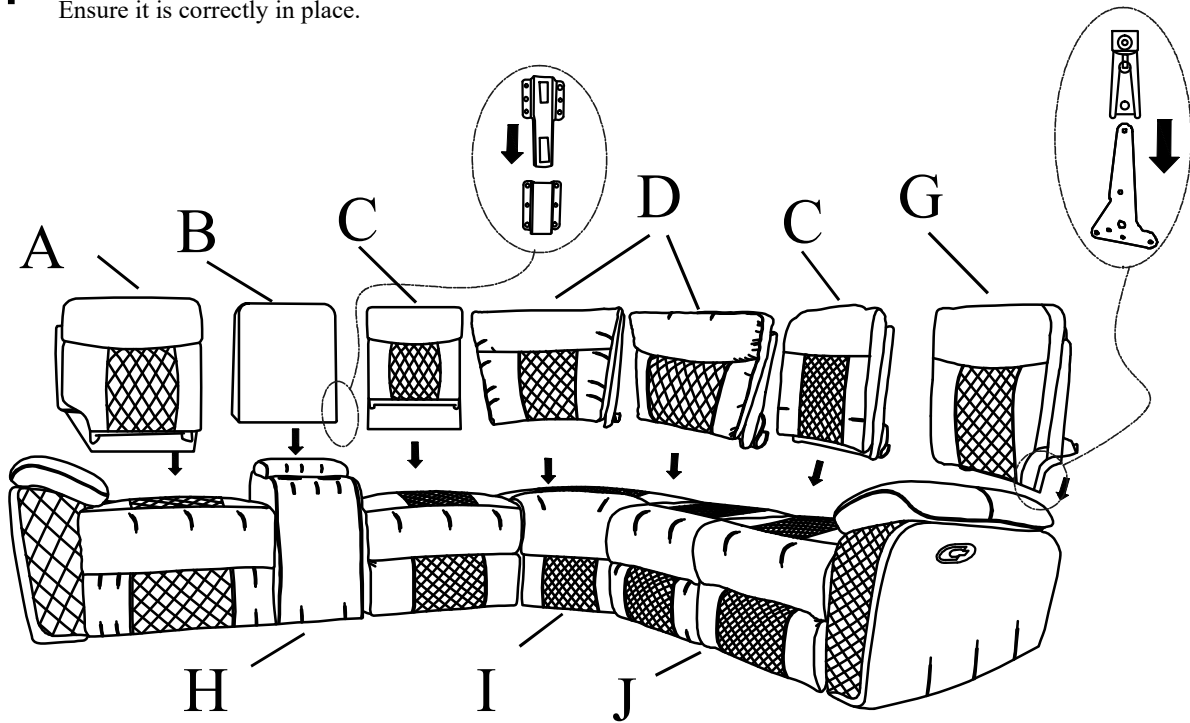

- 5** Stretch and pull down rear cover evenly before securing velcro strip to seat base.  
Repeat if necessary for better fit.

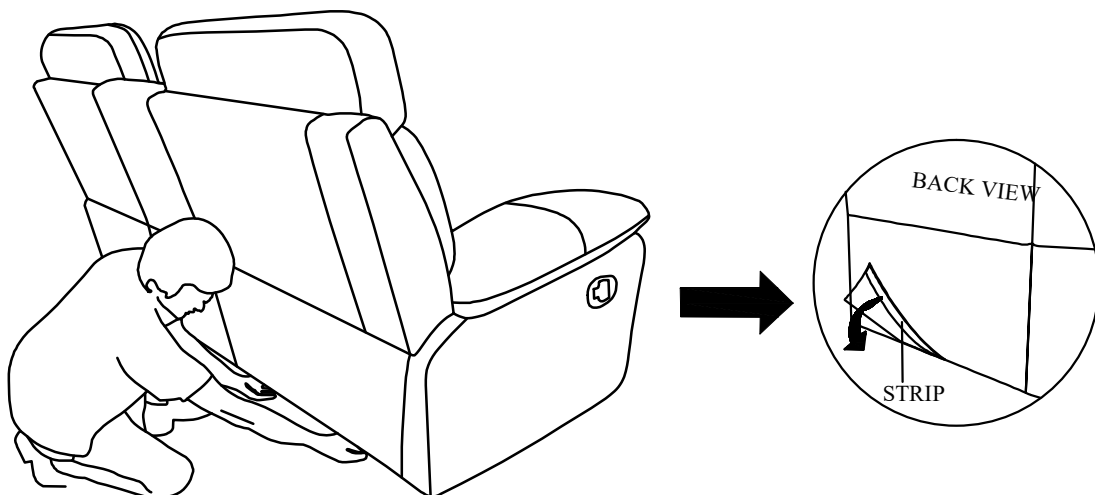

# ASSEMBLY INSTRUCTIONS

DESCRIPTION: SECTIONAL

## OPERATING YOUR UNIT

### Converting to Footrest Position

- To raise or lower the legrest, push the power switch & hold.
- Release the switch when the legrest reaches the desired high

