

WARNING

- * Switch off the main electrical supply from the main fuse box / circuit breaker before installation.
- * Inspect item carefully before attempting to install.
- * If there is any damages or obvious defects, do not install.
- * Item may not be returned once it has been installed.









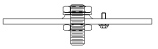

CARE AND MAINTENANCE

- * To clean the outside of the fixture, use a dry or slightly dampened clean cloth (use clean water, never a solvent) to wipe the surface of the fixture.
- * To clean the inside of the fixture, first disconnect power to the fixture by turning off the circuit breaker or by removing the fuse at the fuse box. Next, use a dry or slightly dampened clean cloth (use clean water, never a solvent) to wipe the interior surface of the fixture.
- * Do not use any cleaners with chemical, solvents or harsh abrasives. Use only a dry soft cloth to dust or wipe carefully.

NOTICE& IMPORTANT SAFETY INSTRUCTIONS

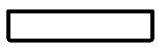



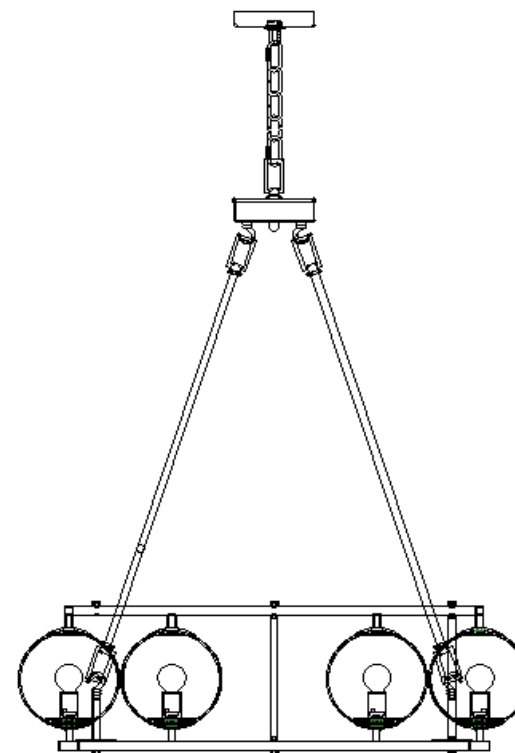

- ** WE RECOMMEND INSTALLATION OF THIS LIGHTING FIXTURE BE DONE BY A LICENSED ELECTRICIAN **
- * Please make sure that you have all parts indicated before you begin assembly of this item
- * This item should be assembled on a soft surface to prevent scratching the finish during assembly
- * To reduce the risk of fire, electrical shock or injury to persons or property, please follow the guideline below for safe use and installation
- *The external flexible cable or cord of this lamp cannot be replaced
If the cord is damaged, the lamp shall be destroyed

Part List and Hardware List

PIECE	DESCRIPTION	PICTURE	QUANTITY	PIECE	DESCRIPTION	PICTURE	QUANTITY
A	Mounting Plate		1X	I	Long Stem		3X
B	Wire Connector		2X	J	Circular embellishment		6X
C	Screw (5/32-32T*25)		3X	K	lamp holder		1X
D	Canopy		1X	L	Open lifting ring		6X
E	Hanging Loop		1X	M	Square tube		6X

Product Dimensions: 30"D X 39.5-98.5"H



PIECE	DESCRIPTION	PICTURE	QUANTITY	PIECE	DESCRIPTION	PICTURE	QUANTITY
F	Canopy Nut		1X	N	lamp body		1X
G	Chain		1X	O	Bulb		6X
G1	Closable Link		2X	P	lamp shade		6X
H	Denggu		1X				

PREPARATION

- * Before beginning assembly of product, make sure all parts are present. Compare parts with package contents list and hardware contents list.
- * If any part is missing or damaged, do not attempt to assemble the product.
- * Estimated Assembly Time: 20 minutes.
- * Tools Required for Assembly (not included): Screwdriver, Junction box
- * If you are having difficulty, our friendly Customer Care team is always here to help.

NOTE: PLEASE USE ON/OFF TYPE "A" BULB MAX 25-WATT OR LED BULB MAX 9-WATT THERE IS LED 4-WATT BULB IN THE BOX

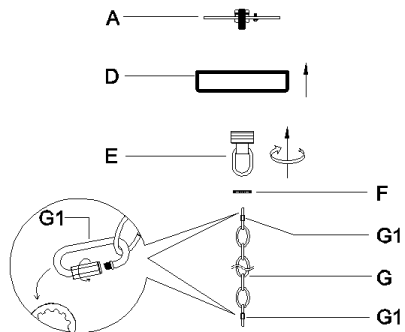

Step 1: Unpack all parts from cartons carefully.
Place the Canopy(D) onto the Hanging Loop(E)
Place the tube of Mounting Plate(A) into the threaded portion of the Hanging Loop(E) and fix it by turning the Canopy Nut(F) clockwise till tight.
Attach the Closable Link(G1) onto the Hanging Loop(E).

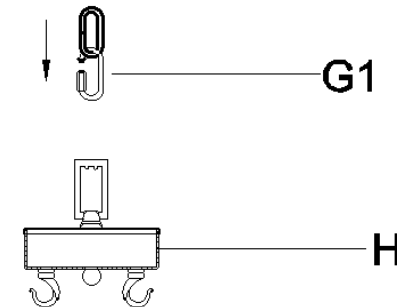

Step 2: Put the closable link(G1) onto the fixture loop(H).

PREPARATION

- * Before beginning assembly of product, make sure all parts are present. Compare parts with package contents list and hardware contents list.
- * If any part is missing or damaged, do not attempt to assemble the product.
- * Estimated Assembly Time: 20 minutes.
- * Tools Required for Assembly (not included): Screwdriver, Junction box
- * If you are having difficulty, our friendly Customer Care team is always here to help.

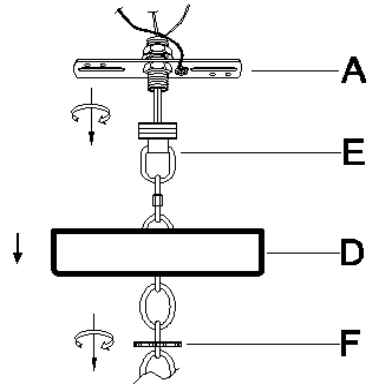

Step 3: Attach the Canopy(D) to the junction box and fix it by turning the Canopy Nut(F) clockwise.

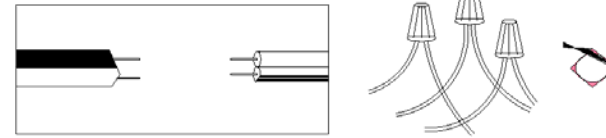

Step 4: Wire connection

Connect fixture neutral wire (ribbed) to the outlet box neutral wire (usually white) using a wire nut. Connect fixture hot wire (smooth with markings) to the outlet box hot wire (usually black) using a wire nut.

CAUTION: Do not reverse the hot and neutral connections

Grounding Instructions:

Wrap ground wire from outlet box around green ground screw on mounting bracket, no less than 2" from wire end. Tighten ground screw. If fixture is supplied with a ground wire, connect to outlet ground wire with a wire connector.

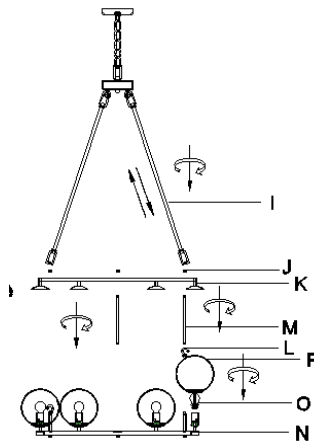

Step 5: Firstly, unscrew the circular decoration (J) on the square tube (M), and then lock the square tube (M) onto the lamp body (N). Use the circular decoration (J) to tighten and install the bulb (O) into the lamp cap on the lamp body (N). Install the lampshade (P) onto the lamp body (N). Unscrew the circular decoration (J) on the square tube (M), install the lamp holder (K) onto the lamp body (N), and tighten it with the circular decoration (J). Finally, connect the long handle (I) to the Open lifting ring (L) of the lamp body (N) and Fixture Loop (H).

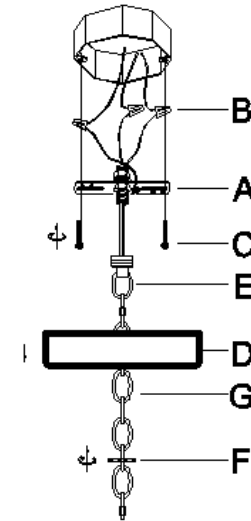

Step 6: Install the Mounting Plate(A) to the junction box with Mounting Screw(C). Separate the Mounting Plate(A) from the Canopy(D) by turning the Canopy Nut(F) anti-clockwise. Install the light lamp shade (L) onto the lamp holder.