

Read all instructions before assembling crib. KEEP INSTRUCTIONS FOR FUTURE USE. Never use plastic shipping bags or other plastic film as mattress covers because they can cause suffocation. Infants can suffocate in gaps between crib sides and a mattress that is too small.

# MAMAZING

## EvoNest Crib



# WARNING

---

Failure to follow these warnings and the instructions could result in death or serious injury.

## SUFFOCATION HAZARD

# Babies have suffocated

- On pillows, comforters, and extra padding
  - In gaps between a wrong-size mattress, or extra padding and product sides.
  - **NEVER** add soft bedding or padding.
  - Use **ONLY** mattress provided by manufacturer.
1. Always place baby on back to sleep to reduce the risk of SIDS and suffocation.
  2. **FALL HAZARD:** To help prevent falls, do not use this product when the infant begins to push up on hands and knees or has reached 30lb, whichever comes first.
  3. If a sheet is used with the pad, use only the one provided by the product manufacturer or one specifically designed to fit the dimension of the product mattress.
  4. Strings can cause strangulation! Do not place items with a string around a child's neck, such as hood strings or pacifier cords. Do not suspend strings over a product or attach strings to toys.
  5. Do not use if any part of the product is broken, torn, or missing.
  6. When child is able to pull to a standing position, set mattress to lowest position and remove bumper pads, large toys and other objects that could serve as steps for climbing out.
  7. Stop using crib when child begins to climb out or reaches the height of 35 in. (89 cm).
  8. After raising side, make sure latches are secure.
  9. **DO NOT** leave child in crib with side lowerd. Be sure side is in raised and locked position whenever child is in crib.
  10. Check this product for damaged hardware, loose joints, loose boltes or other fasteners, missing parts, or sharp edges before and after assembly and frequently during use. Securely tighten loose bolts and other fasteners. **DO NOT** use crib if any parts are missing, damaged or

# WARNING

---

broken. Contact ([service@mamazing.com](mailto:service@mamazing.com)) for replacement parts and instructional literature if needed. **DO NOT** substitute parts.

11. Never use plastic shipping bags or other plastic film as mattress covers because they can cause suffocation.



## WARNING Infants can suffocate

- In gaps between a mattress too small or too thick and product sides
- On soft bedding

**NEVER** add a mattress, pillow, comforter, or padding.

Failure to follow these warnings and the instructions could result in serious injury or death.

1. Never use plastic shipping bags or other plastic film as mattress covers not sold and intended for that purpose. They can cause suffocation.
2. Never use a water mattress with this product.
3. If refinishing, use a nontoxic finish specified for children's products.
4. Top support member must be installed prior to use. Failure to install may result in child falling out of product.
5. Strings can cause strangulation! Never place items with a string around a child's neck such as hood strings or pacifier cords. Never suspend strings over product or attach strings to toys.
6. Discontinue use of the product when child is able to climb out or reaches the height of 35 in. (890 mm).
7. Child can become entrapped and die when improvised netting or covers are placed on top of product. Never add such items to confine child in product.
8. When child is able to pull to standing position, set mattress/base to lowest adjustment position and remove bumper pads, large toys, and other objects that could serve as steps for climbing out.
9. Never place product near a window where cords from blinds or drapes can strangle a child.
10. Use **ONLY** mattress/pad provided by manufacturer (which must be at least 34 in. long by 24 in. wide and not more than 1.9 in. thick)
11. Always provide the supervision necessary for the continued safety of your child. When used for playing, never leave child unattended.
12. To reduce the risk of SIDS, pediatricians recommend healthy infants be placed on their back to sleep, unless otherwise advised by your physician.
13. Never use this product if there are any loose or missing fasteners, loose joints, broken parts, or torn mesh/fabric. Check before assembly and periodically during use. Contact ([service@mamazing.com](mailto:service@mamazing.com)) for replacement parts. Never substitute parts.

# WARNING

---







1. Infants can suffocate on soft bedding. Never add a pillow or comforter. Never place additional padding under an infant.
2. Failure to follow these warnings and the assembly Instructions could result in serious injury or death.
3. To reduce the risk of SIDS, pediatricians recommend healthy infants be placed on their backs to sleep, unless otherwise advised by your physician.
4. Strangulation Hazard: Strings can cause strangulation! DO NOT place items with a string around a child's neck, such as hood strings or pacifier cords. DO NOT suspend strings over a crib or attach strings to toys.
5. To help prevent strangulation tighten all fasteners. A child can trap parts of the body or clothing on loose fasteners.  
DO NOT place crib near window where cords from blinds or drapes may strangle a child.
6. Fall Hazard:
  - When child is able to pull to a standing position, set mattress to lowest position and remove bumper pads, large toys and other objects that could serve as steps for climbing out.
  - Stop using crib when child begins to climb out or reaches the height of 35 in. (89 cm).
7. Check this product for damaged hardware, loose joints, loose bolts or other fasteners, missing parts, or sharp edges before and after assembly and frequently during use. Securely tighten loose bolts and other fasteners. DO NOT use crib if any parts are missing, damaged or broken. Contact ([service@mamazing.com](mailto:service@mamazing.com)) for replacement parts and instructional literature if needed. DO NOT substitute parts.
8. CAUTION: Any mattress used in this crib shall be at least 69 by 131 cm with a thickness not exceeding 15cm.
9. If refinishing, use a non-toxic finish specified for children's products.
10. Follow warnings on all products in a crib.

## CARE & CLEANING

---

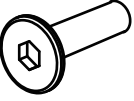
1. Do not scratch or chip the finish.
2. Do not use abrasive chemicals for cleaning.
3. Clean with mild soap on a damp, soft rag.
4. Rinse and dry thoroughly. If you ever refinish this furniture, be sure to use only a non-toxic finish specified for children's products. If you choose to refinish this furniture, the warranty will be voided.

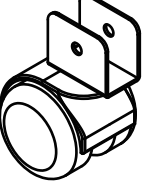
# HARDWARE KIT

				
Ⓐ X 16	Ⓑ X 20	Ⓒ X 12	Ⓓ X 4	Ⓔ X 4
				
Ⓕ X 1	Ⓖ X 1			

# PARTS LIST



① X 2

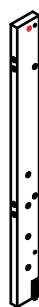

② X 2

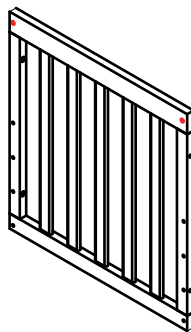

③ X 2

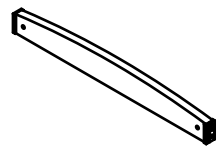

④ X 2

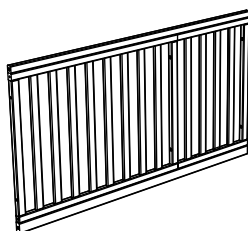

⑤ X 2

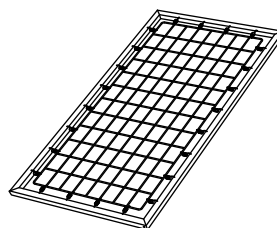

⑥ X 1

# HOW TO ASSEMBLE / Mini-Size Crib

Tip: During assembly, loosely attach the screws first. Once the parts are in position, tighten the screws securely.

- 1 Use 8 screws to fasten the four legs (① X 2, ② X 2) into the holes as shown in the picture, using two screws per leg.

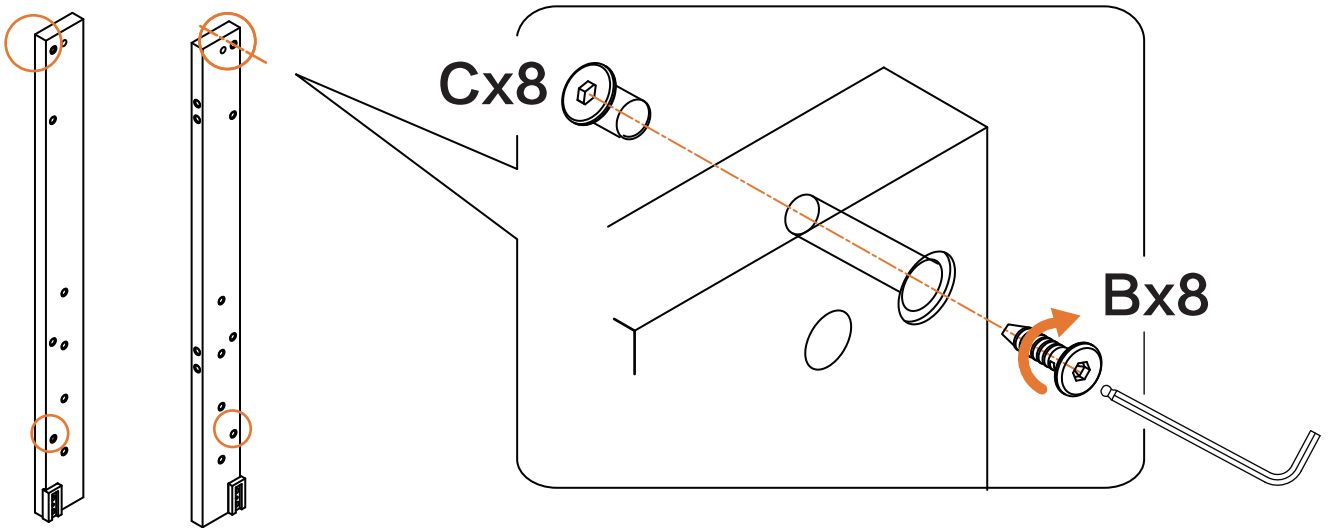

- 2 Attach the headboard (③) to leg (①) using a A screw, then attach leg (②) to the headboard with another A screw.

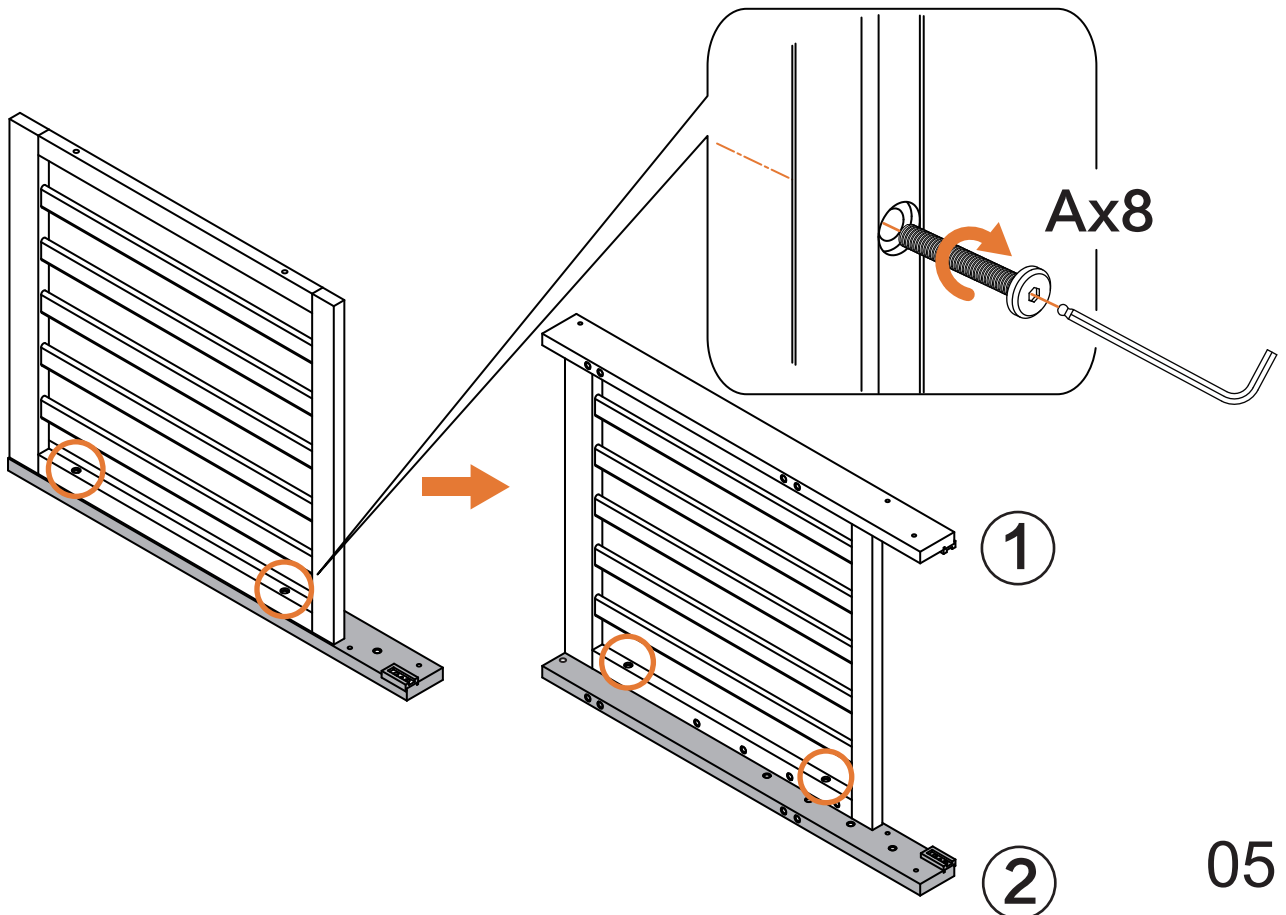

# HOW TO ASSEMBLE / Mini-Size Crib

3

With the bed legs already installed, use A screws to attach bed side (5) to headboard (3). Install the other headboard (3) in the same manner.

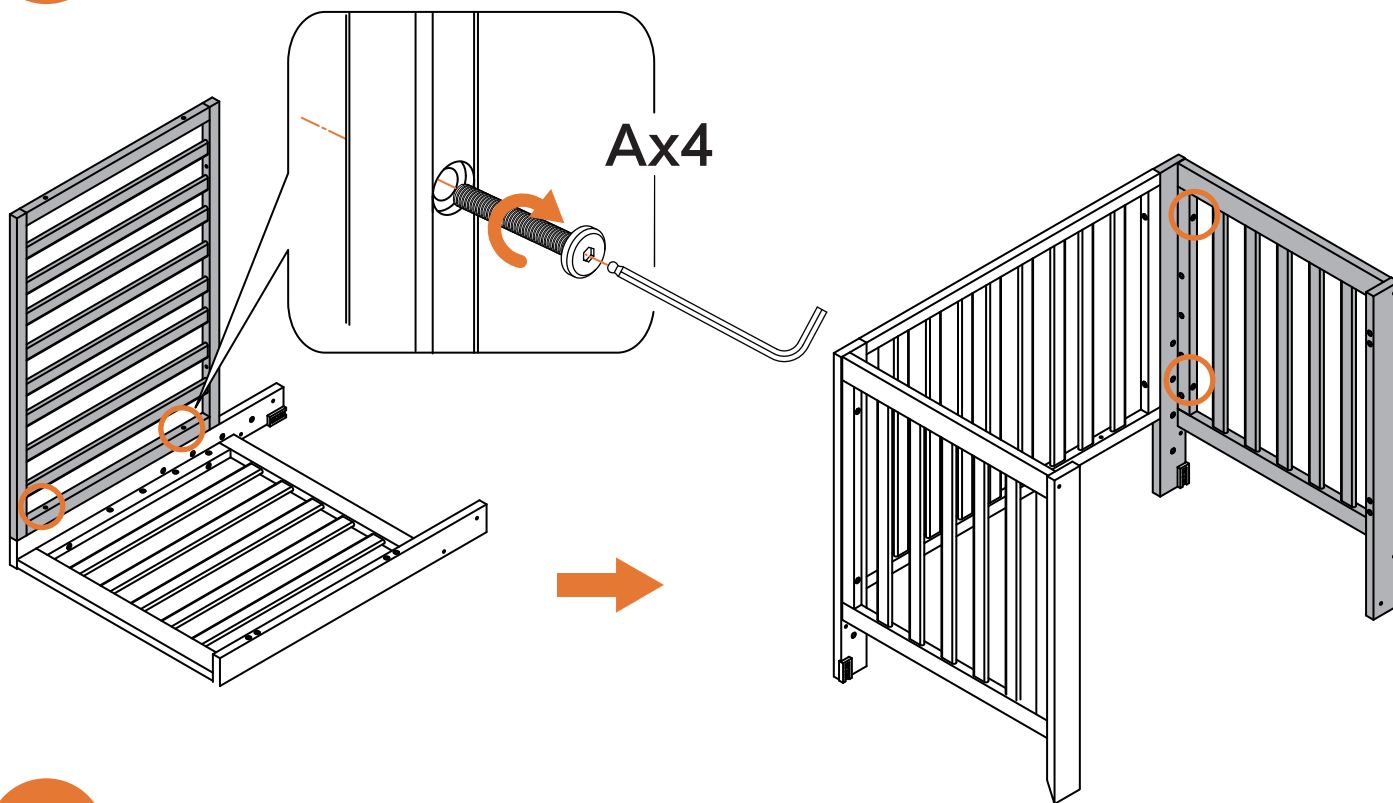

4

Attach 4 L-shaped irons (D) to each side of the two headboards (3) using B screws, as shown.

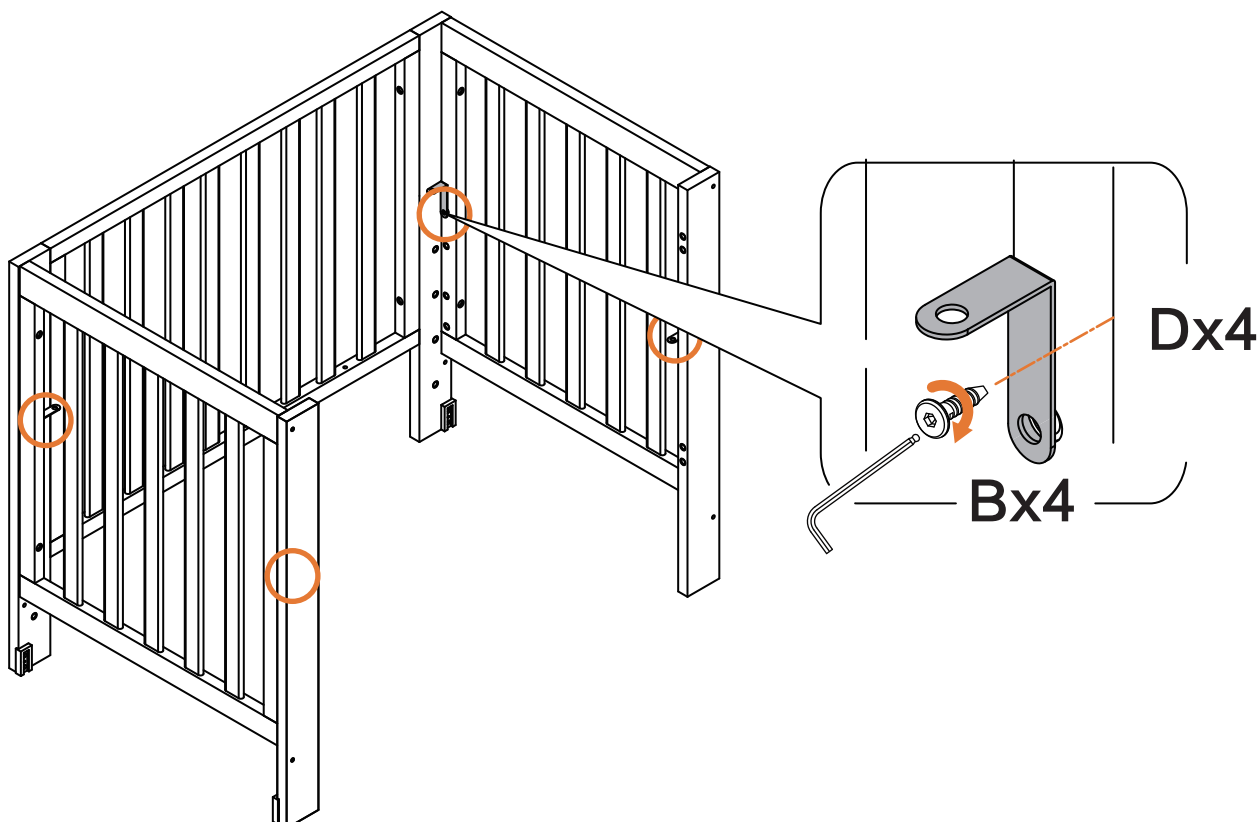

# HOW TO ASSEMBLE / Mini-Size Crib

5

Place the bed base (6) on top of the 4 L-shaped irons (D), and then securely tighten all B screws that hold the L-shaped iron patches in place.

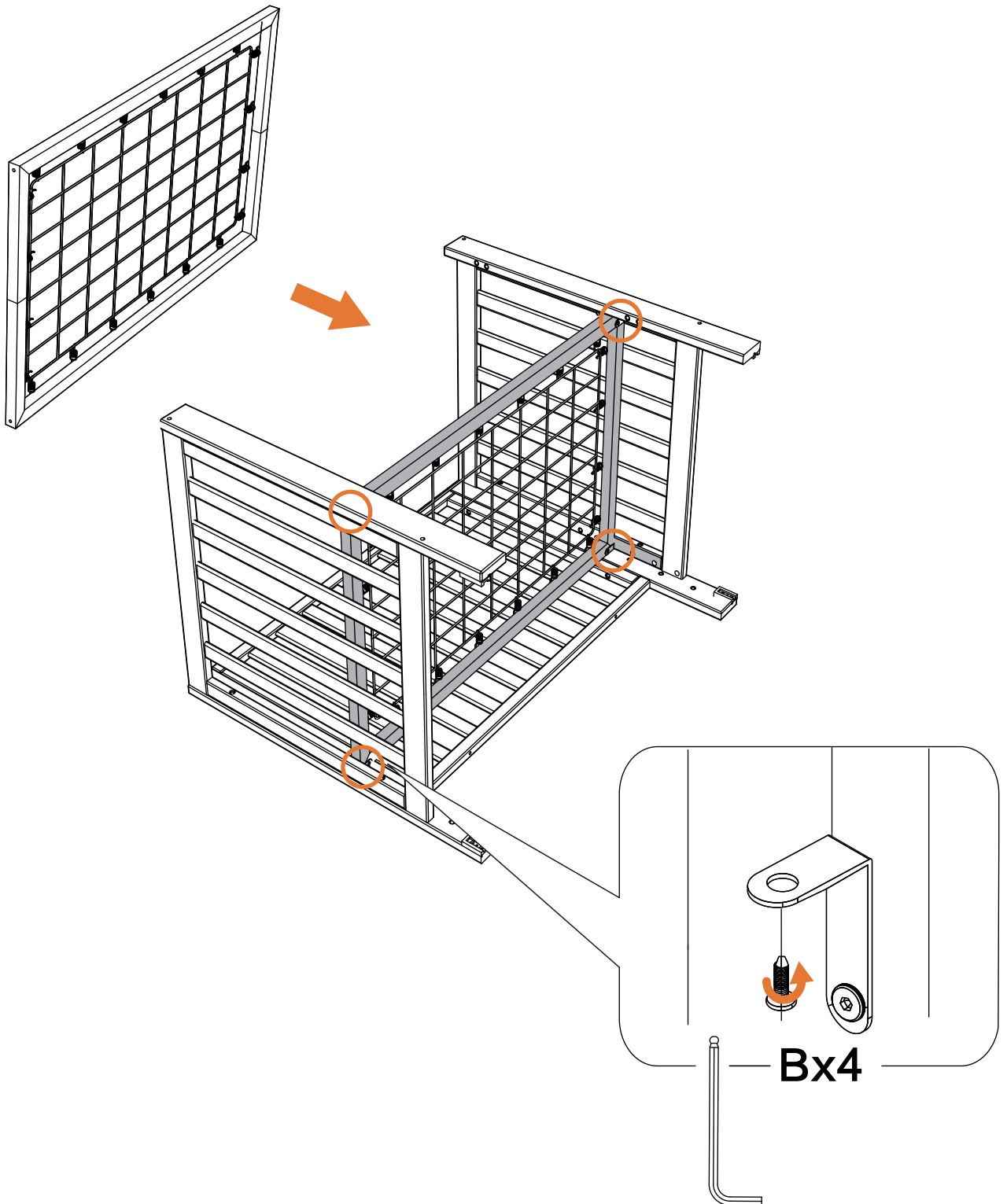

# HOW TO ASSEMBLE / Mini-Size Crib

6

Fasten the other bed side (⑤) to the legs of the bed using A screws. Tighten all four A screws at this point.

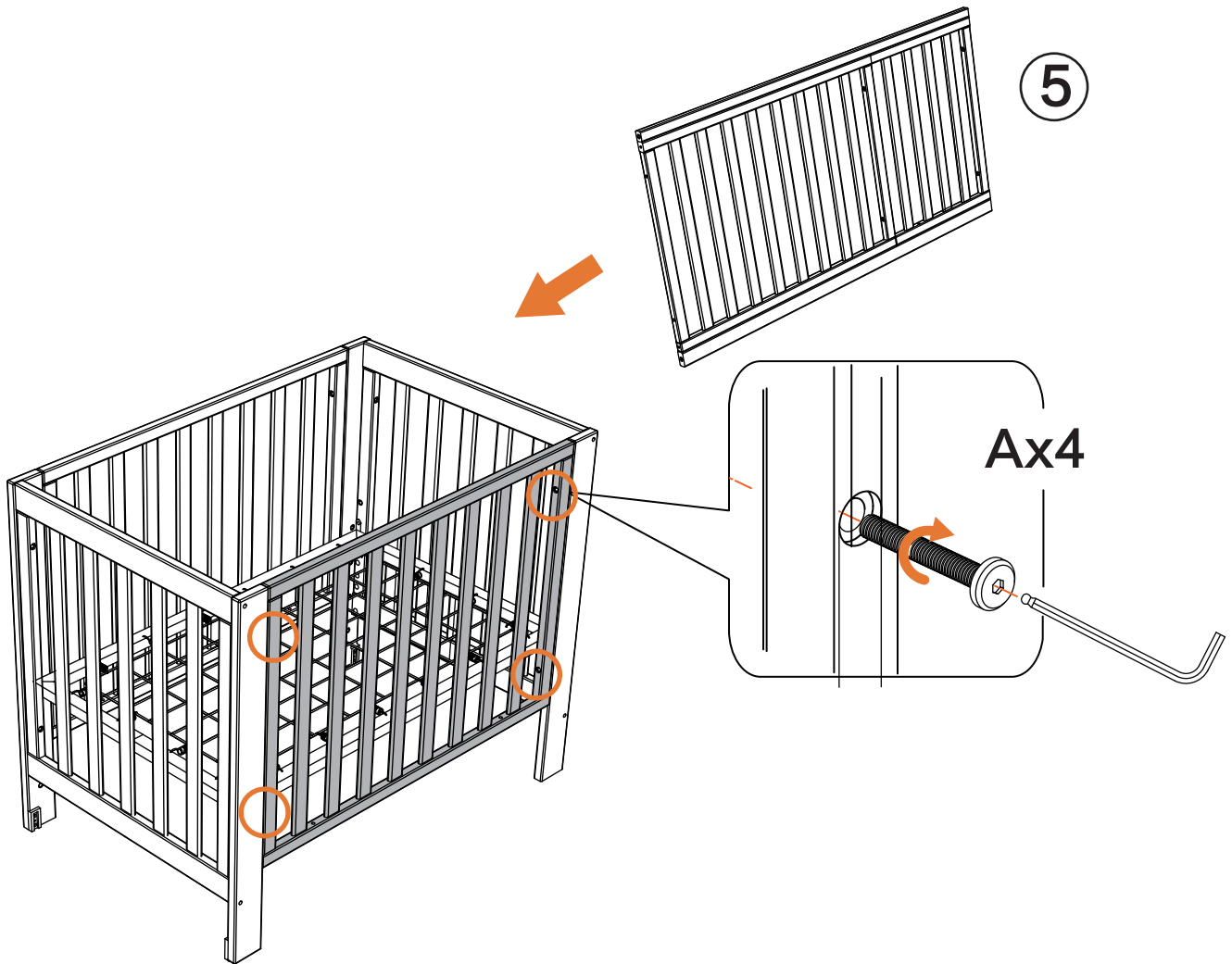

# HOW TO ASSEMBLE / Mini-Size Crib

7

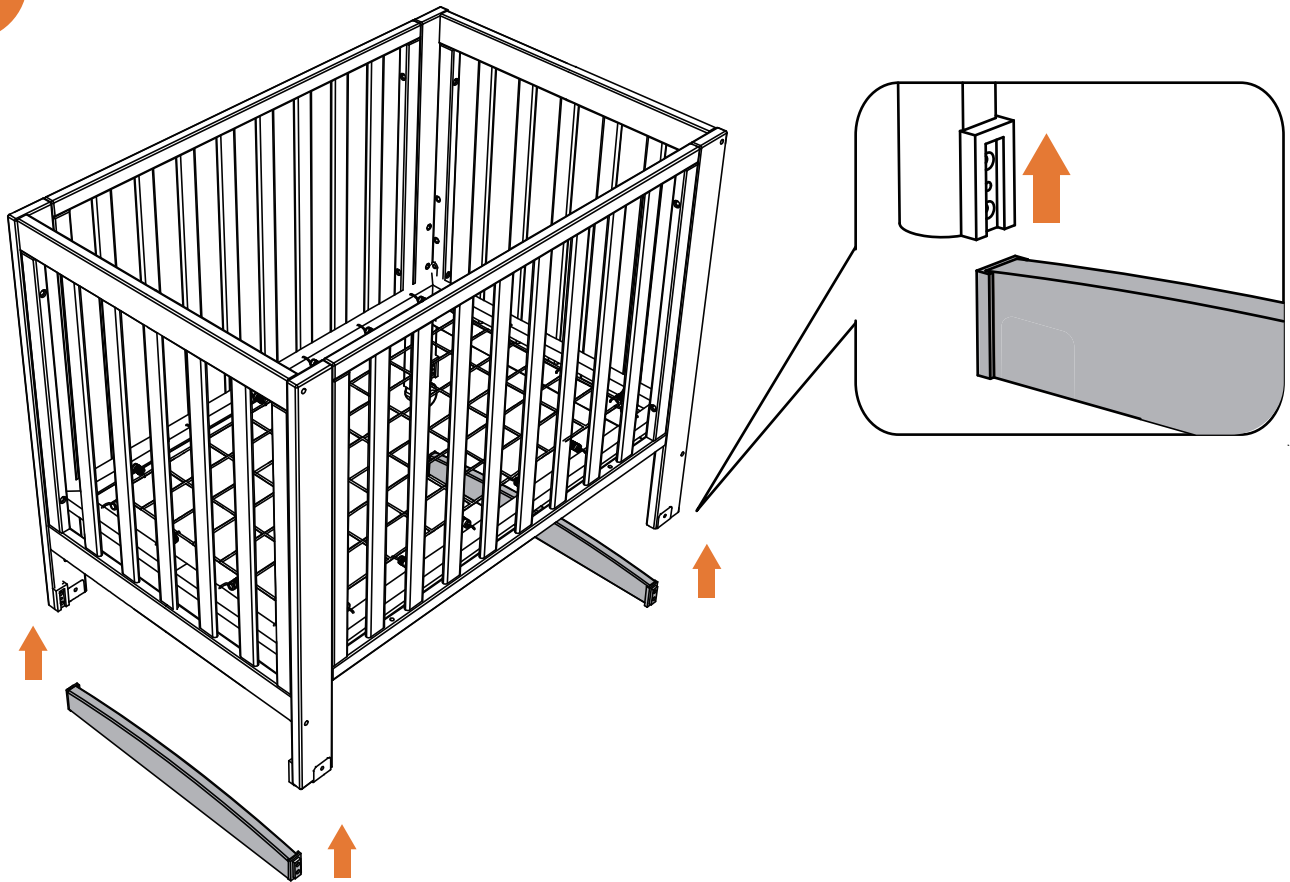

# HOW TO ASSEMBLE / Mini-Size Crib

8

Turn the bed over as shown and securely fasten the castors (E) to the bed legs using C and B screws.

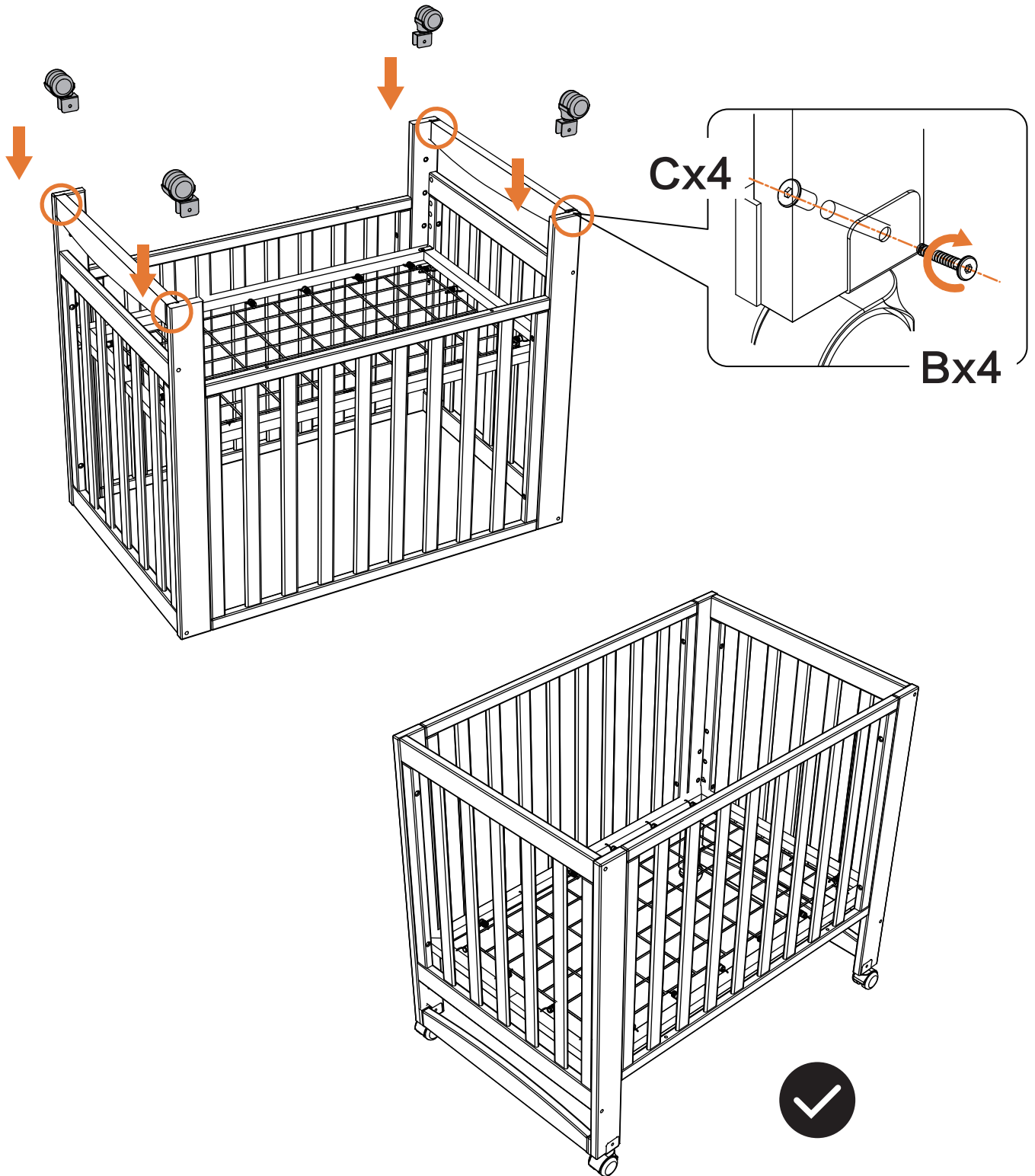

# HOW TO ASSEMBLE / Playpen

1

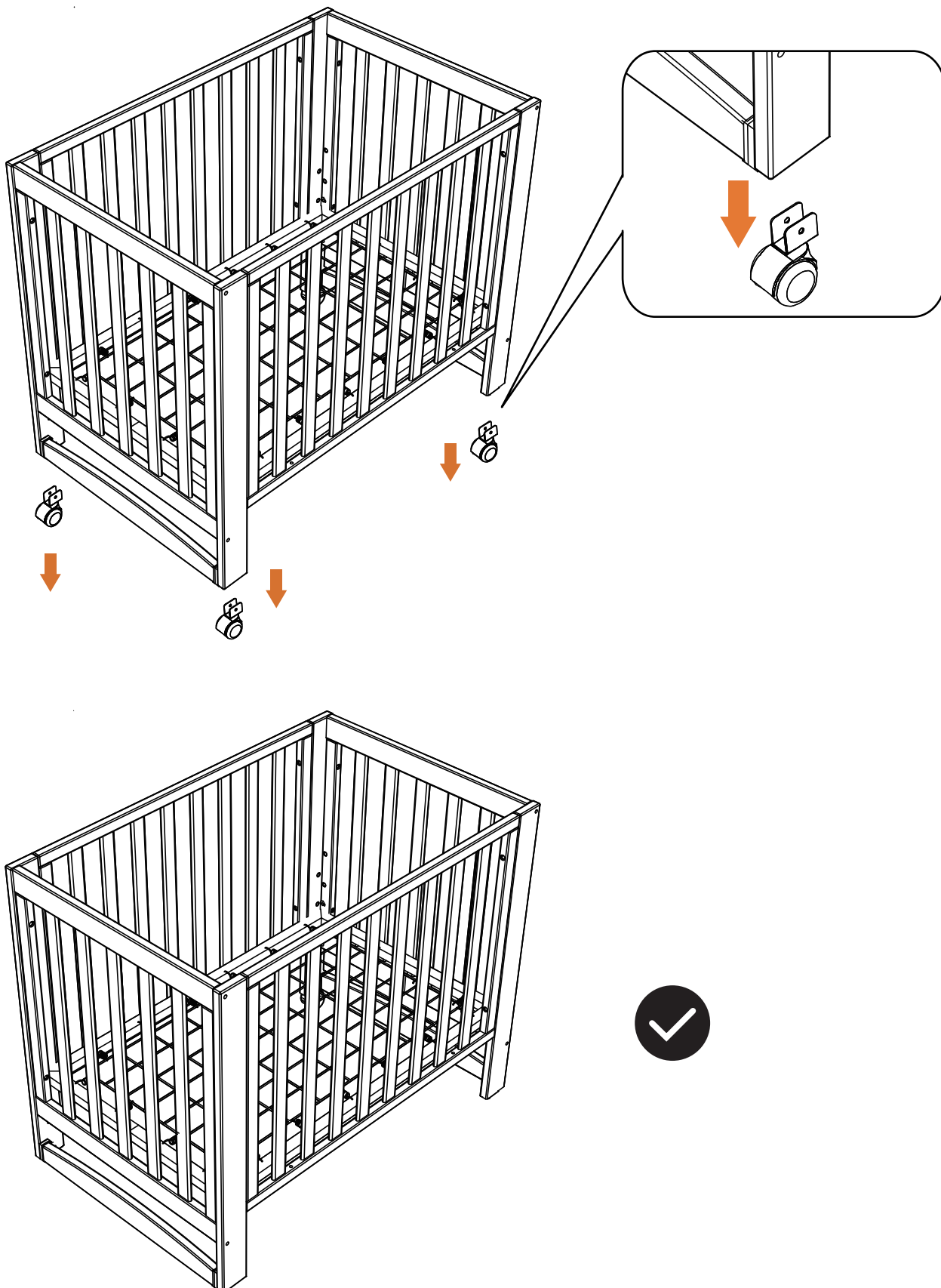

# HOW TO ASSEMBLE / Sofa / Day Bed

1

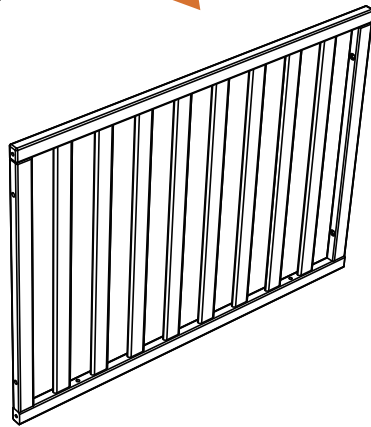
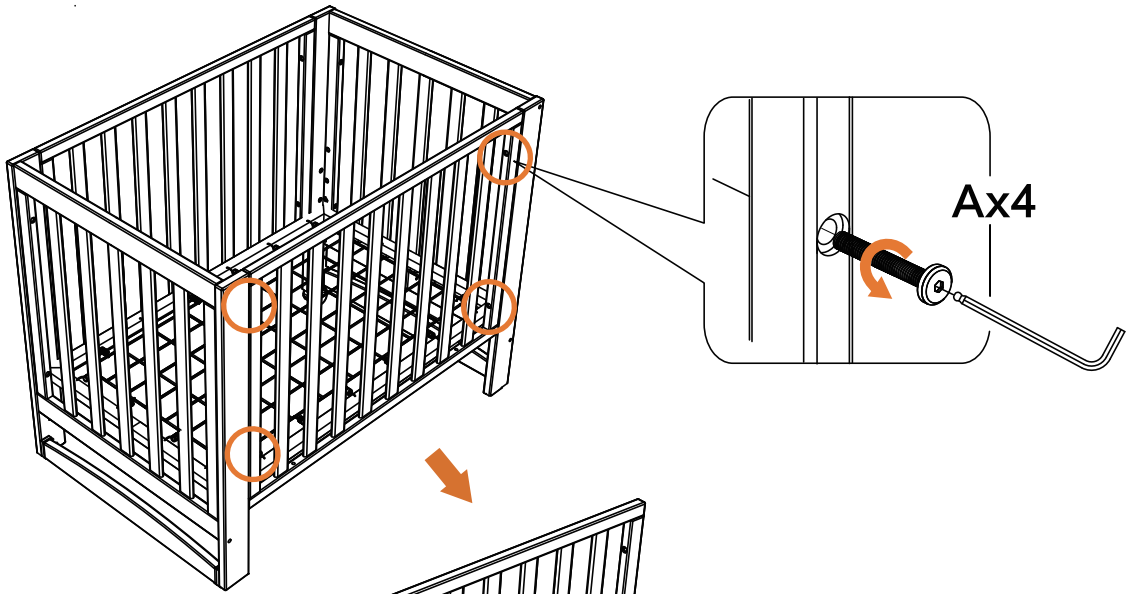

sofa

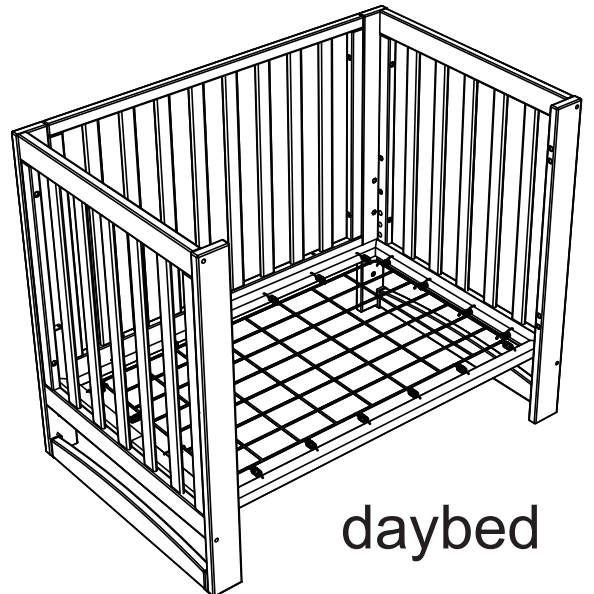

daybed



# HOW TO ASSEMBLE / Cradle

1

Pull both rockers (④) down and out, flip them 180°, then snap them back into the slots on the bed legs to switch to the rocker function.

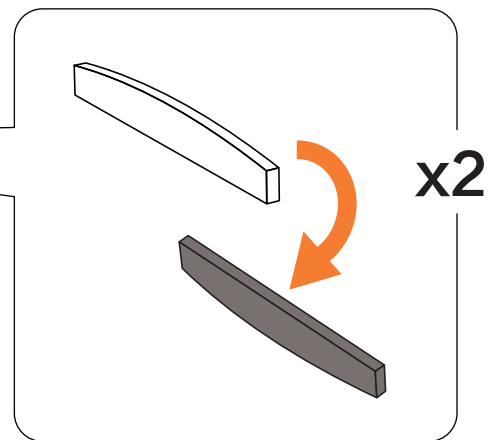
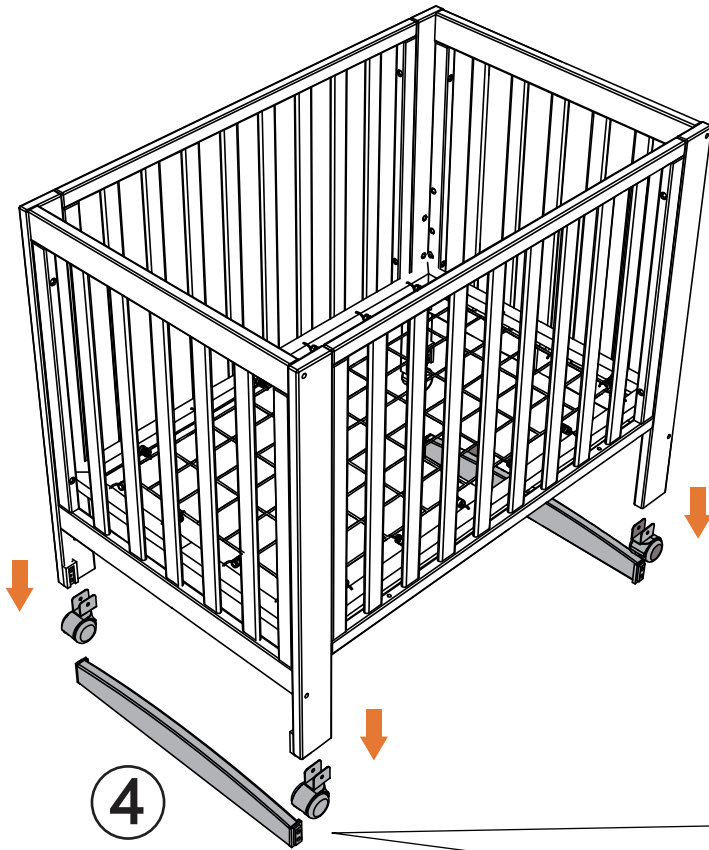

MAVANZINING