

ASSEMBLY INSTRUCTIONS



Fine Furniture for every stage of life

Round Dining Table

ASSEMBLY INSTRUCTIONS

ASSEMBLY TIPS:

1. Remove hardware from box and sort by size.
2. Please check to see that all hardware and parts are present prior to start of assembly.
3. Please follow attached instructions in the same sequence as numbered to assure fast & easy assembly.



WARNING!

1. Don't attempt to repair or modify parts that are broken or defective. Please contact the store immediately.
2. This product is for home use only and not intended for commercial establishments.

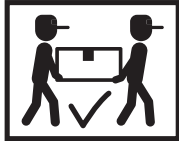

ASSEMBLY TIME

15 MINUTES

PARTS IDENTIFICATION

No	DESCRIPTION & FIGURE	QTY
A	<p>Table top</p>	1pc
B	<p>Main Post</p>	1pc
C	<p>Mounting frame</p>	1pc
D	<p>Table base</p>	1pc

ZN-HARDWARE PACKAGE:

No	DESCRIPTION	FIGURE	QTY
1	Large Bolt	 M10×40mm	1pc
2	Medium Bolt	 M6×35mm	8pcs
3	Small Bolt	 M6×12mm	4pcs
4	Big Washer		1pc
5	Spring Washer		1pc
6	ALLEN KEY (4mm)		1pc
7	ALLEN KEY (8mm)		1pc
8	Small Washer		8pcs

STEP 1

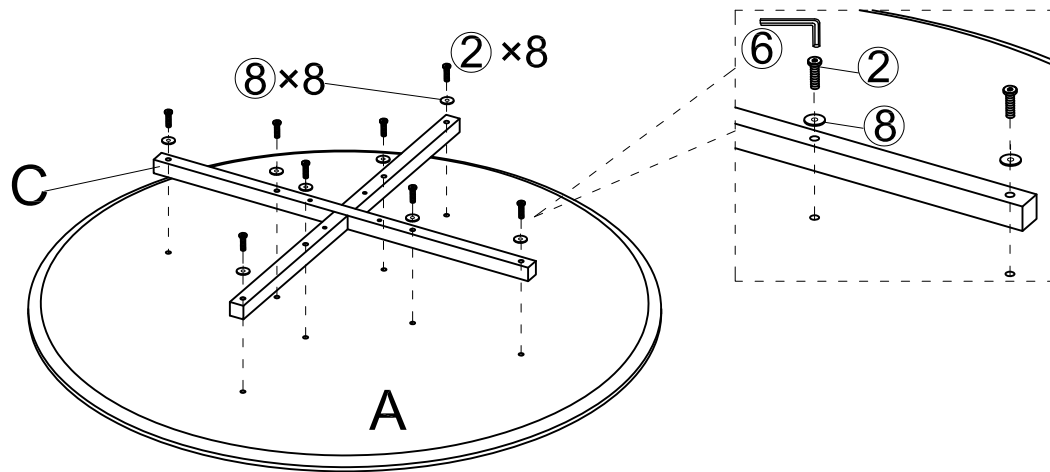

STEP 2

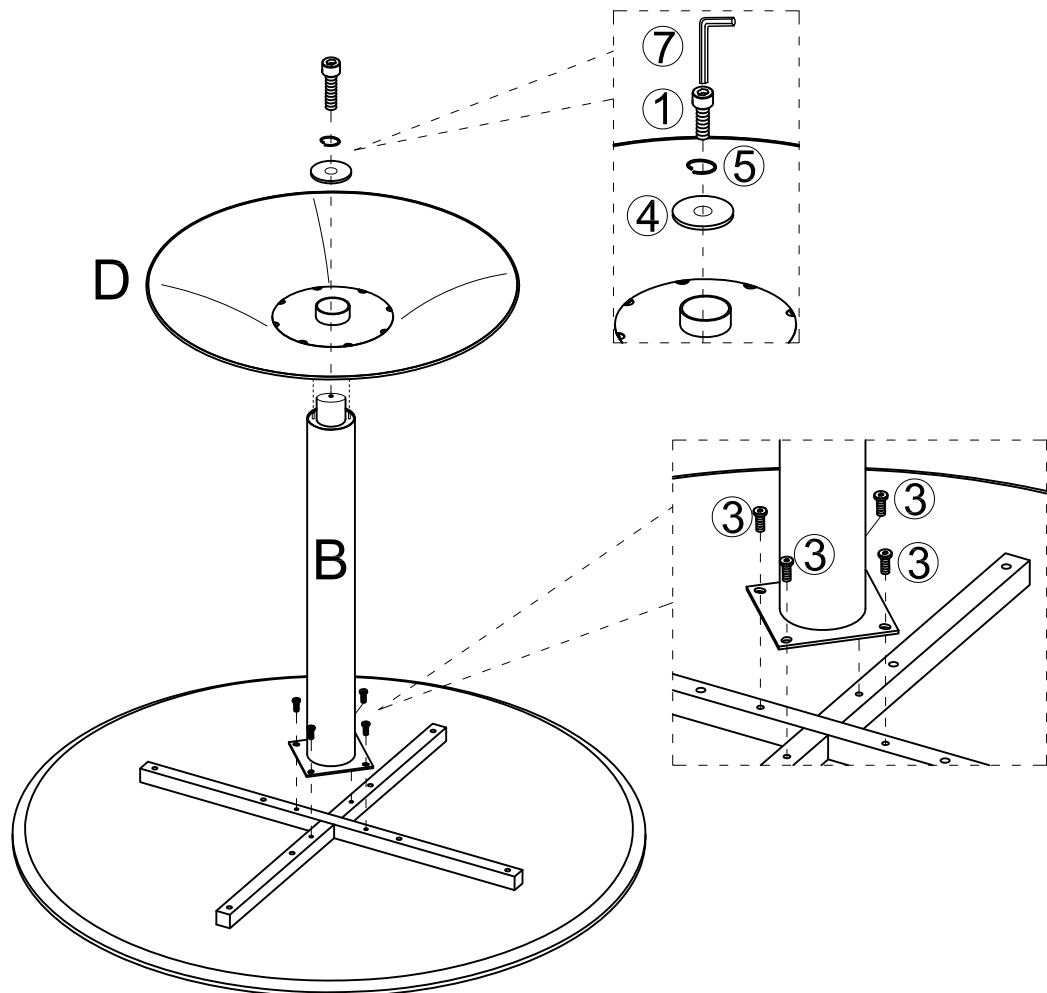

STEP 3

COMPLETE

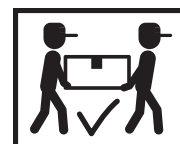
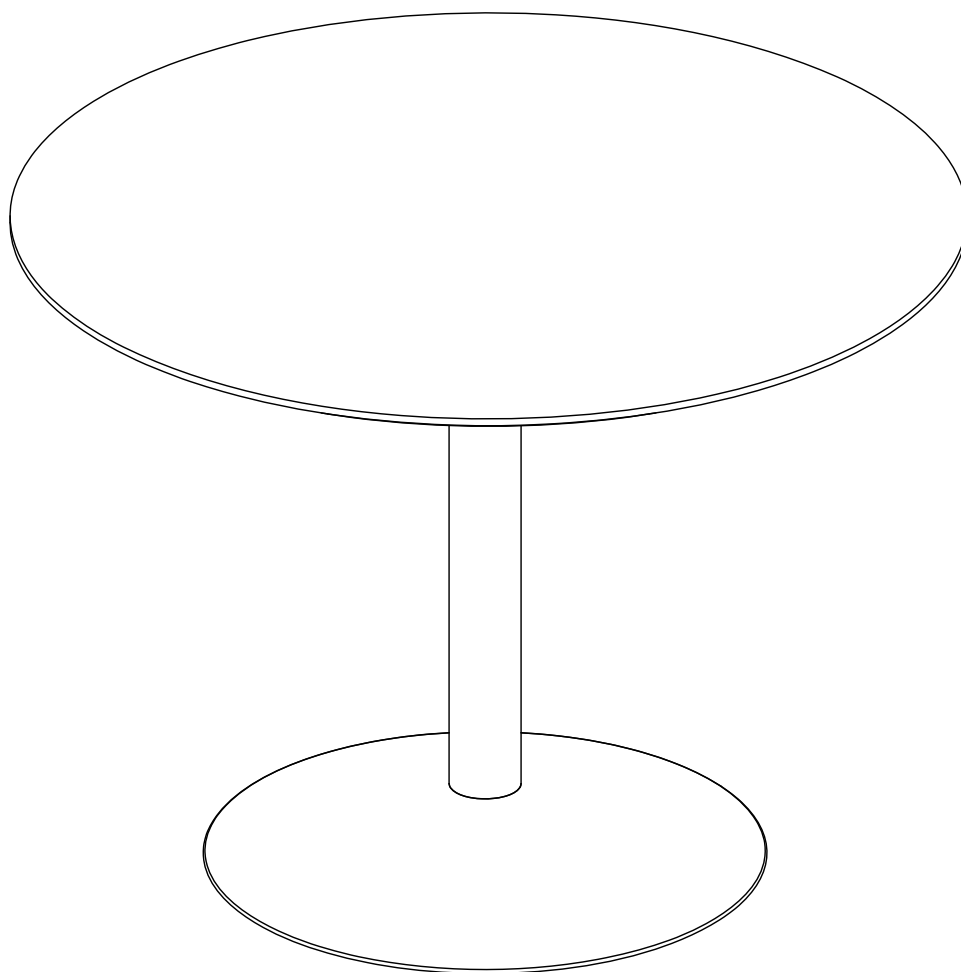

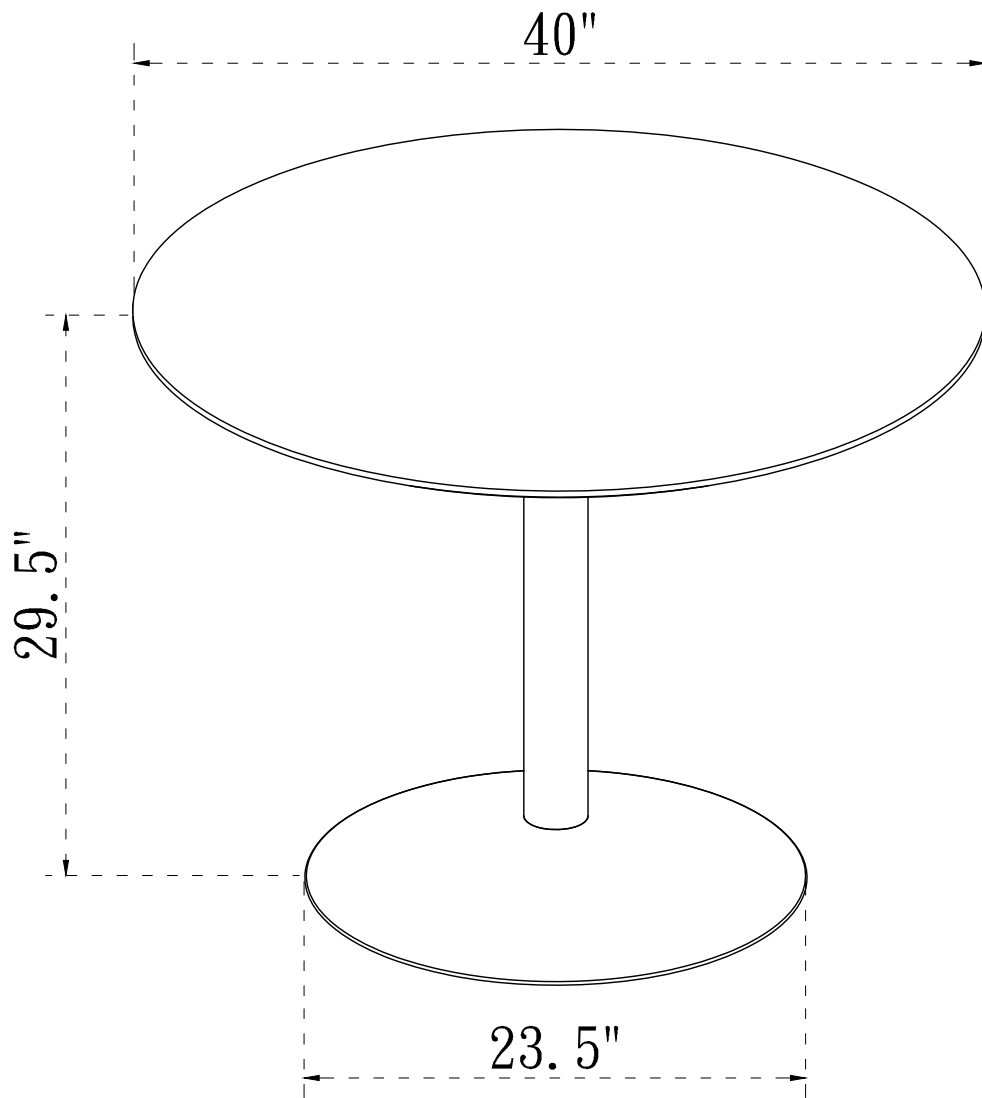

Note: Dimension tolerance $\pm 5\%$