

WARNING!!

Furniture Tipping Risk.

Serious risk of severe or fatal crush injuries can occur from furniture tipping over if not secured.

Children like to climb on furniture and Unsecured furniture can pose a serious danger.

Please follow all instructions and install the tip-over restraints provided.



Assembly Instructions

Caution: You must read this before you proceed

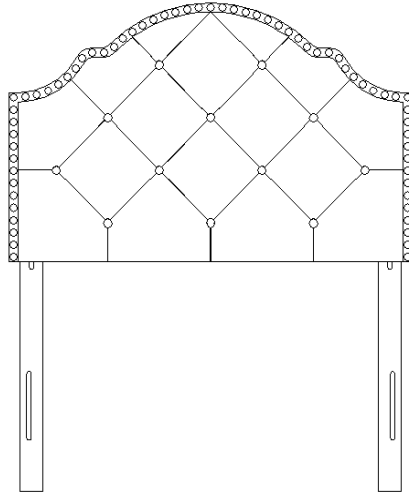

Headboard

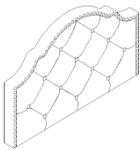













Parts list

Label	Picture	Description	QTY
A		Headboard	1
B		Left Support Leg	1
C		Right Support Leg	1

Hardware

Label	Picture	Description	QTY
①		Bolt(M8 x 35mm)	5
②		Spring Washer ϕ 8.5mm	5

③		Washer $\phi 8.5\text{mm} \times \phi 38$	9
④		Nut(M8)	5
⑤		Allen Key(5mm)	1
⑥		Wrench	1
⑦		Strap	2
⑧		Screw(M4 x 50mm)	2
⑨		Screw(M4 x 15mm)	2
⑩		Metal Pad	4
⑪		Bolt(M8 x 45mm)	5
⑫		Wall Plug	2
⑬		Hammer(Not Provided)	1
⑭		Power Drill (Not Provided)	1
⑮		Washer $\phi 8.5 \times \phi 20$	5

Assembly Preparation

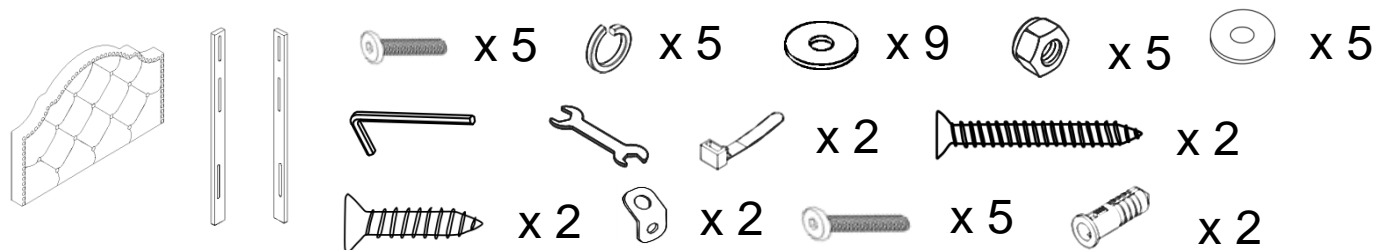

- Read instructions, cover to cover-



- Have 2 adults on hand for assembly-



- Do not assemble on flooring or carpet-



- Assemble on a clean non-marring surface (packing foam)-



- Save all packaging until finished-

Assembly Steps

Overview

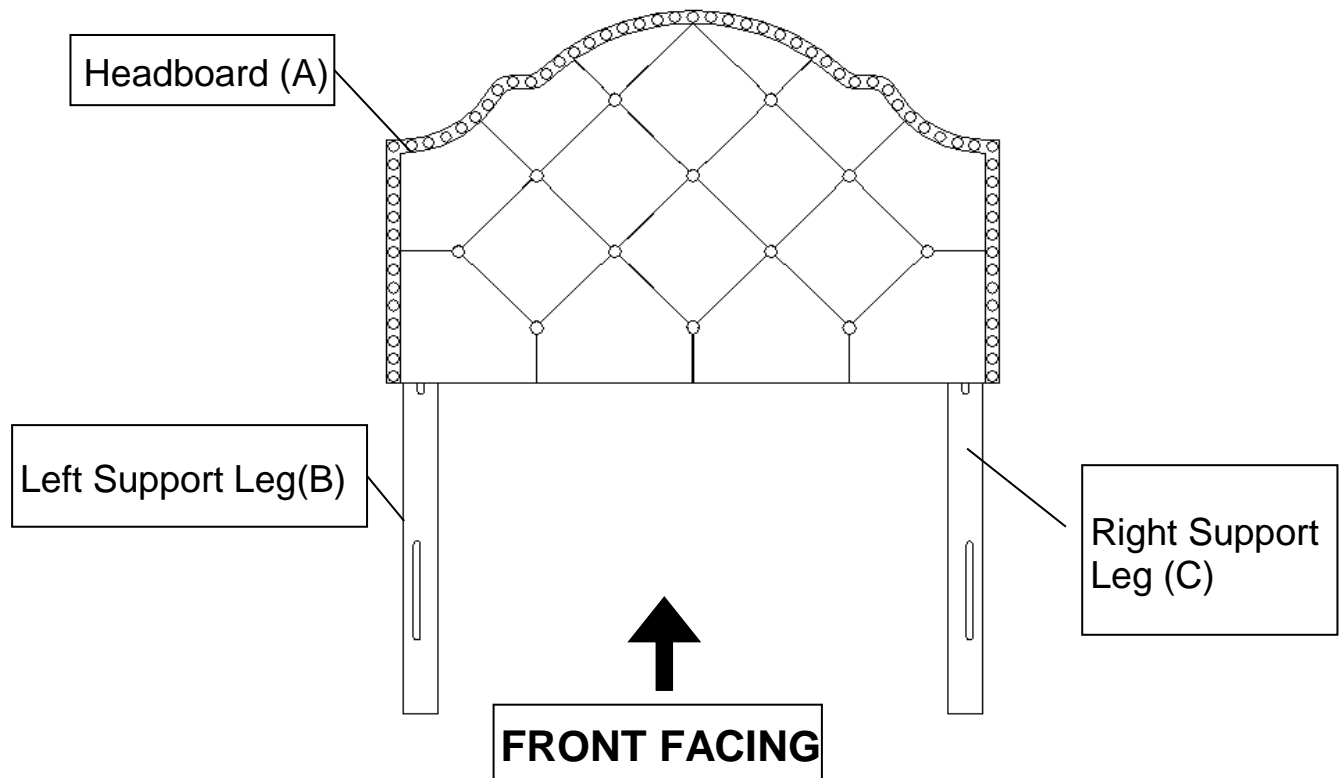

This Headboard has multiple parts and may require up to 30 minutes to assemble.

To give you an overview of the Headboard parts, the above picture is to help you put the various Headboard parts into perspective.

Please read through the instructions below to familiarise yourself with the parts and steps before assembly.

Step 1

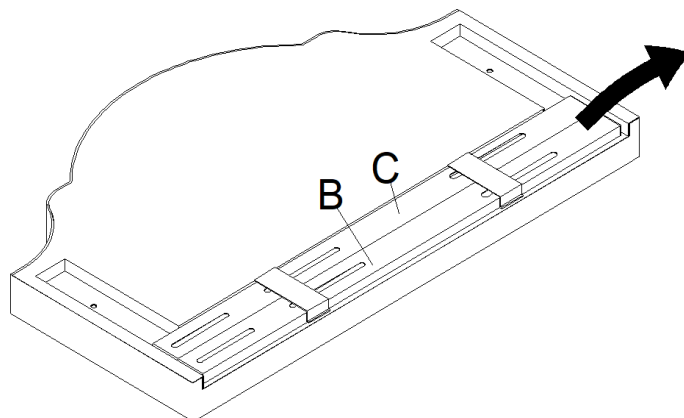

Lay Headboard(A) facedown onto a flat, soft, clean surface.
Take Support Leg(B&C) out from the back of Headboard(A).

Step 2

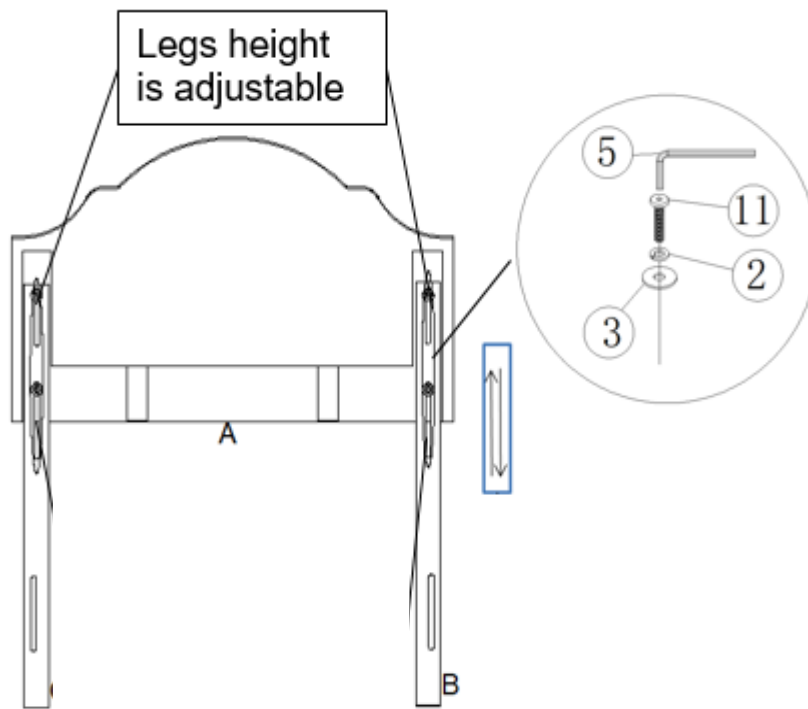

Align the mounting positions on Headboard(A) to those on Left Support Leg(B).

Attach Headboard(A) to Left Support Leg(B) using Bolts(11), Washers(3) and Spring Washers(2) with Allen Key(5).

Repeat the same process with Right Support Leg(C).

At this point of assembly, do not overtighten the connections.

The final height of the Headboard may be adjusted to your own need.

Caution: The mounting position need show as pix.

Step 3

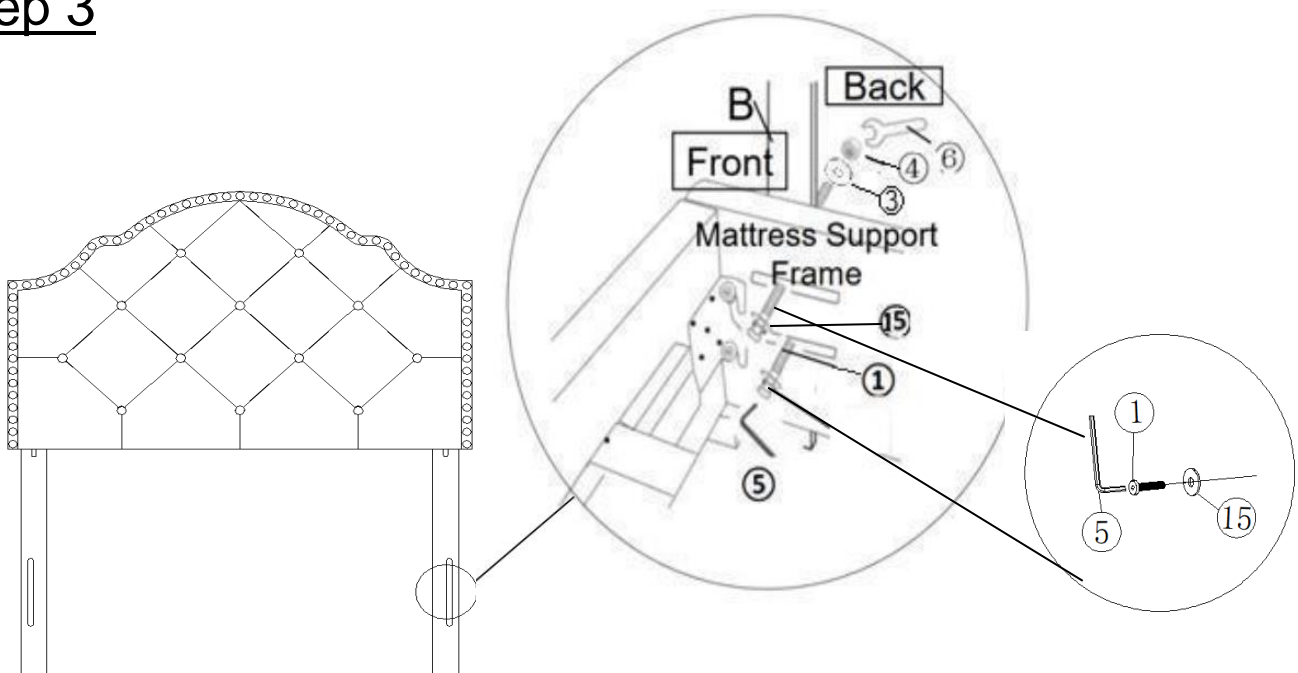

With the assistance of your adult partners, turn over the assembled rails. Attach Support Leg(B/C) to the assembled Rail using Bolts(①), Washers(③), Washers(⑮) and Nuts(④) with Allen Key(⑤) and Wrench(⑥).

Step 4

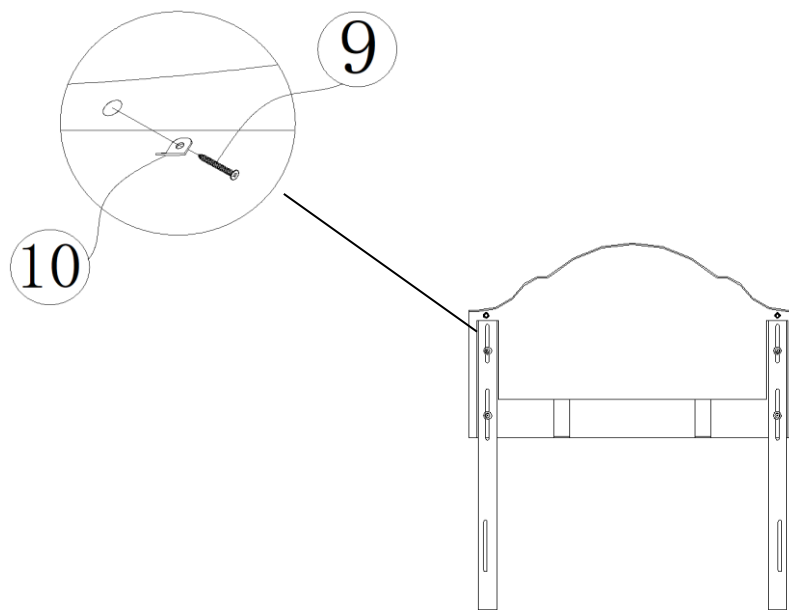

Firstly, turn back the Headboard. Locate the two marks on the product. Then, attach Metal Pads(⑩) to the back of Headboard(A) using Bolts(⑨). Make sure two parts are connected and securely locked into headboard.

Step 5

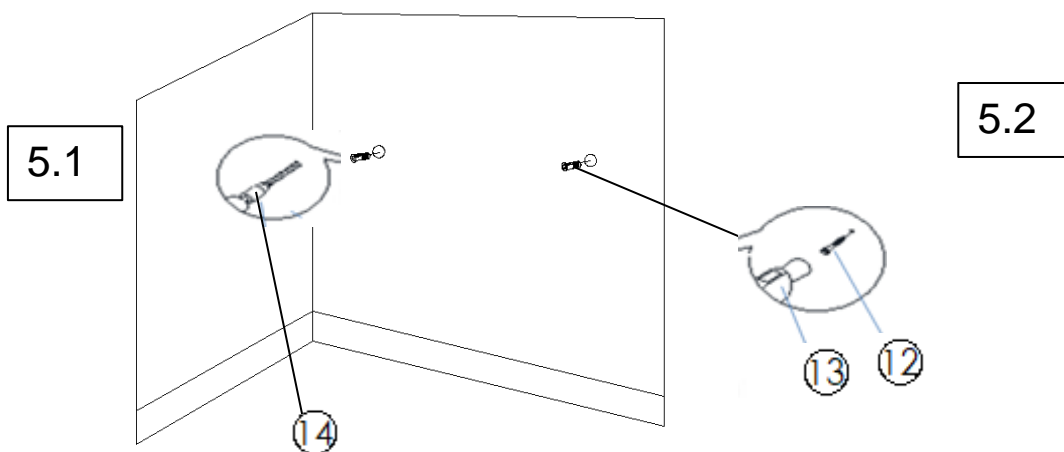

5.1) Drill two holes on wall at the same height as Metal Pad(⑩) on Headboard with Power Drill(⑭).

You can mark these points in two ways as below:

1) Move the Headboard back to the wall. Mark two points at the same height as the Headboard on the wall.

Note: The Metal Pad need to be secured to solid, load bearing surface. Please use a Stud Finder(not supplied) if needed to locate the Wall Frame.

2) Measure the height of the Metal Pad(⑩) with ruler/measuring tape and mark on wall to keep them accurate and same height.

5.2) Insert Wall Plug(⑫) into drilled mounting position on wall with Hammer(⑬).

Step 6

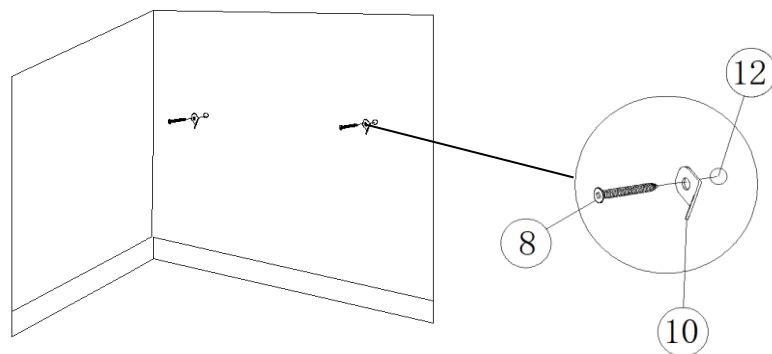

Put the Headboard against the wall where desired and mark the location for the Metal Pad(⑩) to be the same height as the top of the Headboard.

Attach Metal Pad(⑩) to Wall Plug(⑫) using Bolt(⑧).

Note: The Metal Pads need to be secured to solid, load bearing surface. Please use a Stud Finder(not supplied) if needed to locate the Wall Frame.

Step 7

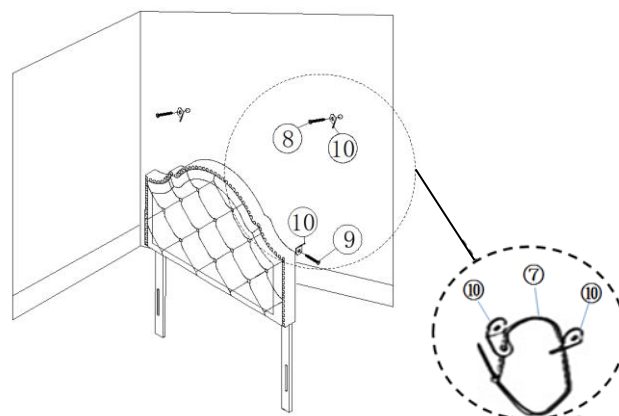

Move Headboard to the wall.

Pull the Strap(⑦) through the Metal Pad(⑩) on the wall and Headboard one by one, and pull the Strap(⑦) tight.

Headboard Restraint Device is installed.

Care & Maintenance



- Do not put hot items directly on furniture surface



- Do not clean furniture with harsh cleansers or polish.



- Do not place furniture under direct sunlight.



- Do not place furniture near heating or cooling vents.



- Do not write on furniture without a padded barrier to protect the surface.



- Do not place furniture outside . For indoor use only .



- Not for commercial use. For residential use only .



- Stains may be removed with mild soap solution and damp cloth.



- Children should not climb or jump on the furniture.



- Dust and pick-up spills using a clean, non-colored, lint-free cloth .