

















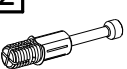
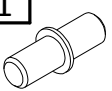
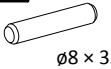

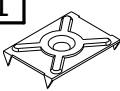

## INSTRUKCJA MONTAŻU ASSEMBLY INSTRUCTIONS

Akcesoria / Fittings							
<b>W1</b>  Ø3 × 16 12 szt. / pcs	<b>ZM1</b>  8 szt. / pcs	<b>W3</b>  Ø3,5 × 16 12 szt. / pcs	<b>W4</b>  Ø4 × 16 51 szt. / pcs	<b>W5</b>  Ø4 × 35 1 szt. / pcs	<b>W6</b>  Ø6.3 × 50 32 szt. / pcs	<b>G1</b>  36 szt. / pcs	
<b>M1</b>  8 szt. / pcs	<b>M2</b>  8 szt. / pcs	<b>B1</b>  12 szt. / pcs	<b>K1</b>  Ø8 × 35 8 szt. / pcs	<b>TZ1</b>  1 szt. / pcs	<b>S1</b>  4 szt. / pcs	<b>T1</b>  11 szt. / pcs	
<b>ZW1</b>  32 szt. / pcs	<b>N1</b>  4 szt. / pcs	<b>N2</b>  4 szt. / pcs	<b>U1</b>  6 szt. / pcs	<b>U2</b>  Ø4 × 30 6 szt. / pcs	<b>D1</b>  2 szt. / pcs	<b>D2</b>  410 mm 1 szt. / pcs	
<b>P5-A</b>  2 szt. / pcs	<b>P5-B</b>  2 szt. / pcs	<b>P6-A</b>  2 szt. / pcs	<b>P6-B</b>  2 szt. / pcs	<b>Z1-A</b>  6 szt. / pcs	<b>Z1-B</b>  6 szt. / pcs		
<b>Q1</b>  1 szt. / pcs	<b>Q2</b>  1 szt. / pcs						

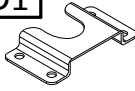
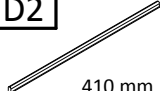
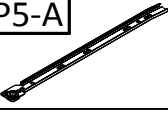
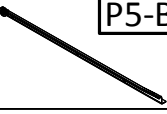
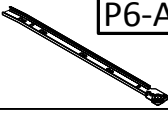
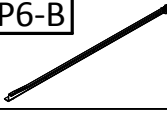
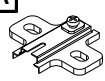
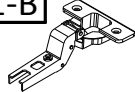
Narzędzia / Tools		
		

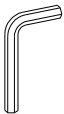
**DO MONTAŻU POTRZEBNE SĄ DWIE OSOBY!  
INSTALLATION REQUIRES TWO PEOPLE!**

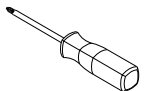
**BARDZO WAŻNE!**  
**NALEŻY UWAŻNIE PRZECZYTAĆ**  
**ZACHOWAĆ DO PÓŹNIEJSZEGO STOSOWANIA**

**INSTRUKCJA OBSŁUGI**

1.

By zapobiec zadławieniu lub uduszeniu opakowanie z akcesoriami należy trzymać w miejscu niedostępnym dla niemowląt i dzieci.

2.

Wszystkie połączenia w meblu muszą być dobrze dokręcone, żaden z elementów łączących nie może być luźny.

3.

Nie należy używać szafy jeśli jakikolwiek element jest uszkodzony lub brakuje elementu.

4.

Należy używać tylko elementów dopuszczonych przez producenta.

5.

Nie należy w pobliżu szafy umieszczać otwartych źródeł ognia oraz innych silnych źródeł ciepła, jak promienniki gazowe lub elektryczne itp., gdyż grozi to pożarem.

6.

Szafę należy przytwierdzić do ściany za pomocą dołączonej taśmy zabezpieczającej!

**VERY IMPORTANT!**  
**PLEASE READ CAREFULLY**  
**SAVE FOR FUTURE USE**

**USER'S MANUAL**

1.

To avoid the danger of choking or strangulation keep the package with fittings away from babies and children.

2.

All connections must be tightened properly and no coupled element can not be loose.

3.

Do not use the wardrobe when, if any of the elements is damaged or if there is any element missing.

4.

Use only the elements given by manufacturer.

5.

Do not place the wardrobe near naked flames or other heat sources such as electric or gas radiators etc., this may cause a fire.

6.

The wardrobe must be fixed to the wall using the supplied roll-over protection tape!

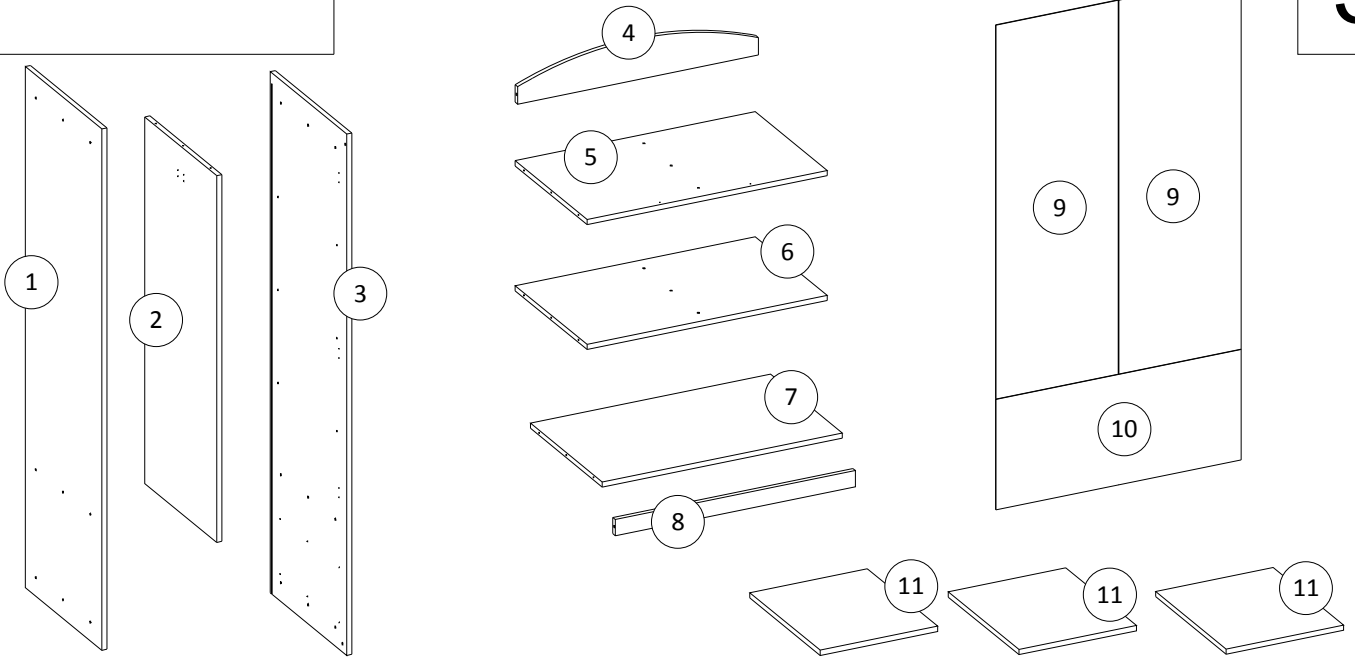

<b>Paczka 1 z 2 / Package 1 of 2</b>		
Numer elementu / Item no.	Wymiary (mm) / Dimensions (mm)	Ilość / Quantity
1	1800 x 540 x 18	1
2	1266 x 507 x 18	1
3	1800 x 540 x 18	1
9	431 x 1292 x 3	2
10	864 x 380 x 3	1
12	420 x 1290 x 18	1
13	420 x 1290 x 18	1
14	500 X 138 X 18	1
<b>Paczka 2 z 2 / Package 2 of 2</b>		
Numer elementu / Item no.	Wymiary (mm) / Dimensions (mm)	Ilość / Quantity
4	846 x 140 x 18	1
5	846 x 507 x 18	1
6	846 x 507 x 18	1
7	846 x 507 x 18	1
8	846 x 56 x 18	1
11	414 x 497 x 18	3
14	500 x 138 x 18	1
15	500 x 138 x 18	2
16	785 x 120 x 18	2
17	842 x 188 x 18	2
18	803 x 504 x 3	2

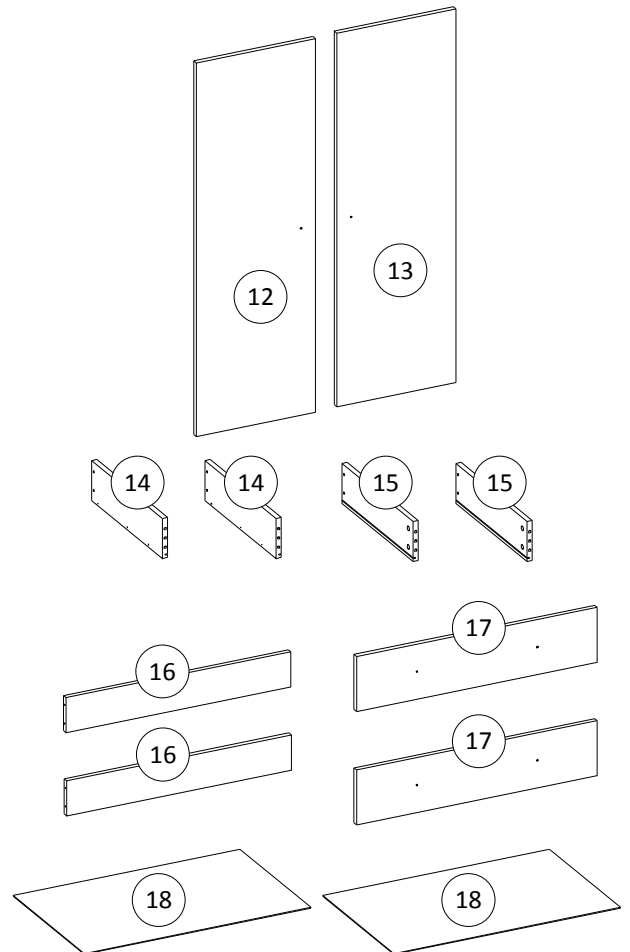

PRZED MONTAŻEM MEBLA NALEŻY DOKŁADNIE SPRAWDZIĆ CZY PACZKI ZAWIERAJĄ WSZYSTKIE ELEMENTY WYSZCZEGÓLNIONE W TABELCE NA STRONIE 3 ORAZ CZY ELEMENTY TE NIE SĄ USZKODZONE !!!  
JEŚLI BRAKUJE ELEMENTÓW LUB NIEKTÓRE Z NICH SĄ USZKODZONE PROSIMY O KONTAKT Z NASZYM BIUREM OBSŁUGI KLIENTA.  
USZKODZENIA ELEMENTÓW STWIERDZONE JUŻ PO MONTAŻU MEBLA NIE BĘDĄ UWZGLĘDNIANE !!!

BEFORE ASSEMBLING THE FURNITURE PLEASE CHECK THAT PACKAGES INCLUDE ALL ITEMS LISTED IN THE TABLE ON PAGE NO 3,  
AND WHETHER THESE ITEMS ARE NOT DAMAGED !!!  
IF MISSING PARTS OR SOME OF THEM ARE DAMAGED, PLEASE CONTACT OUR CUSTOMER SERVICE OFFICE.  
DAMAGES FOUND AFTER ASSEMBLING WILL NOT BE CONSIDERED !!!

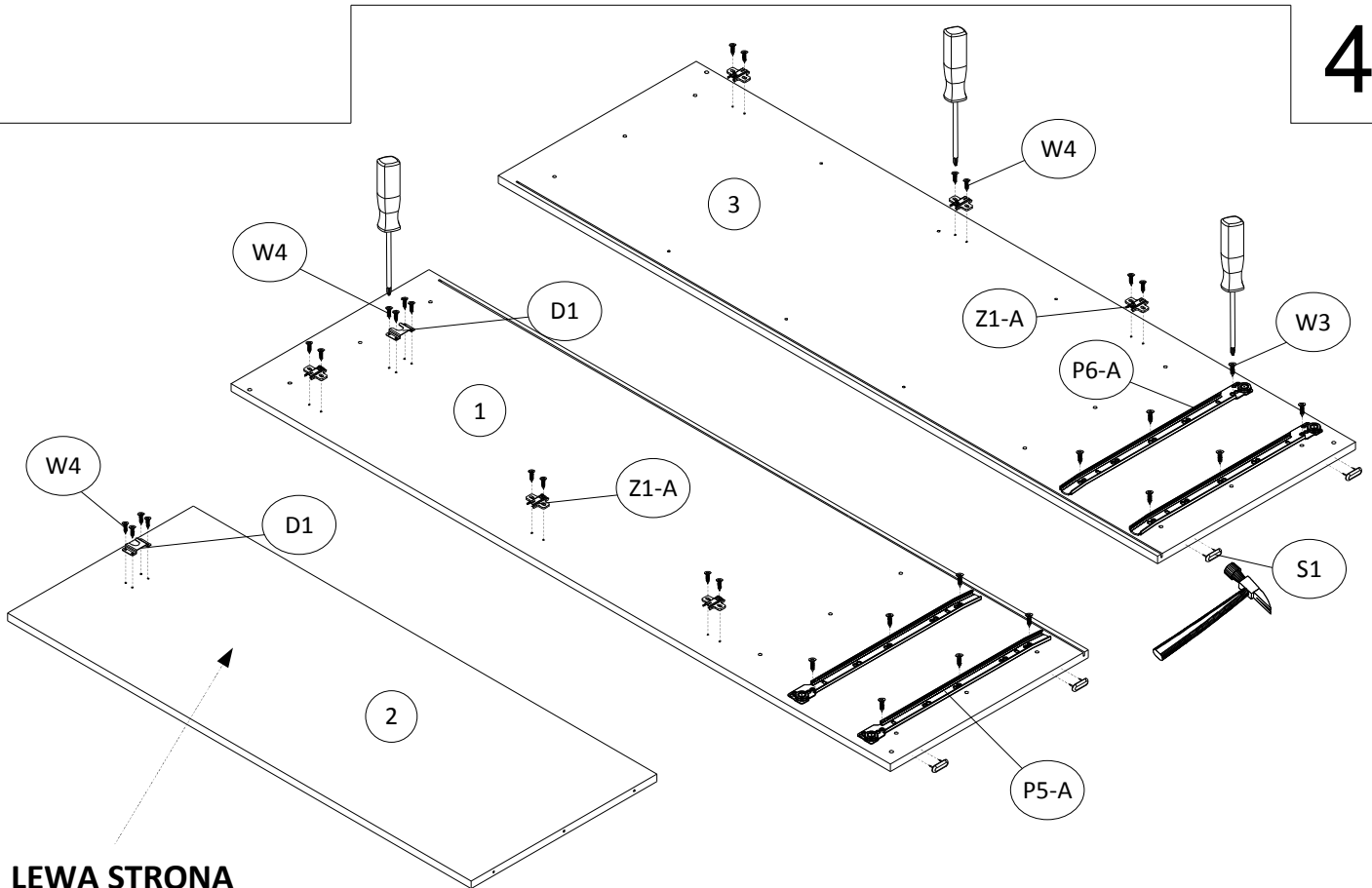

**LEWA STRONA**  
**LEFT SIDE**

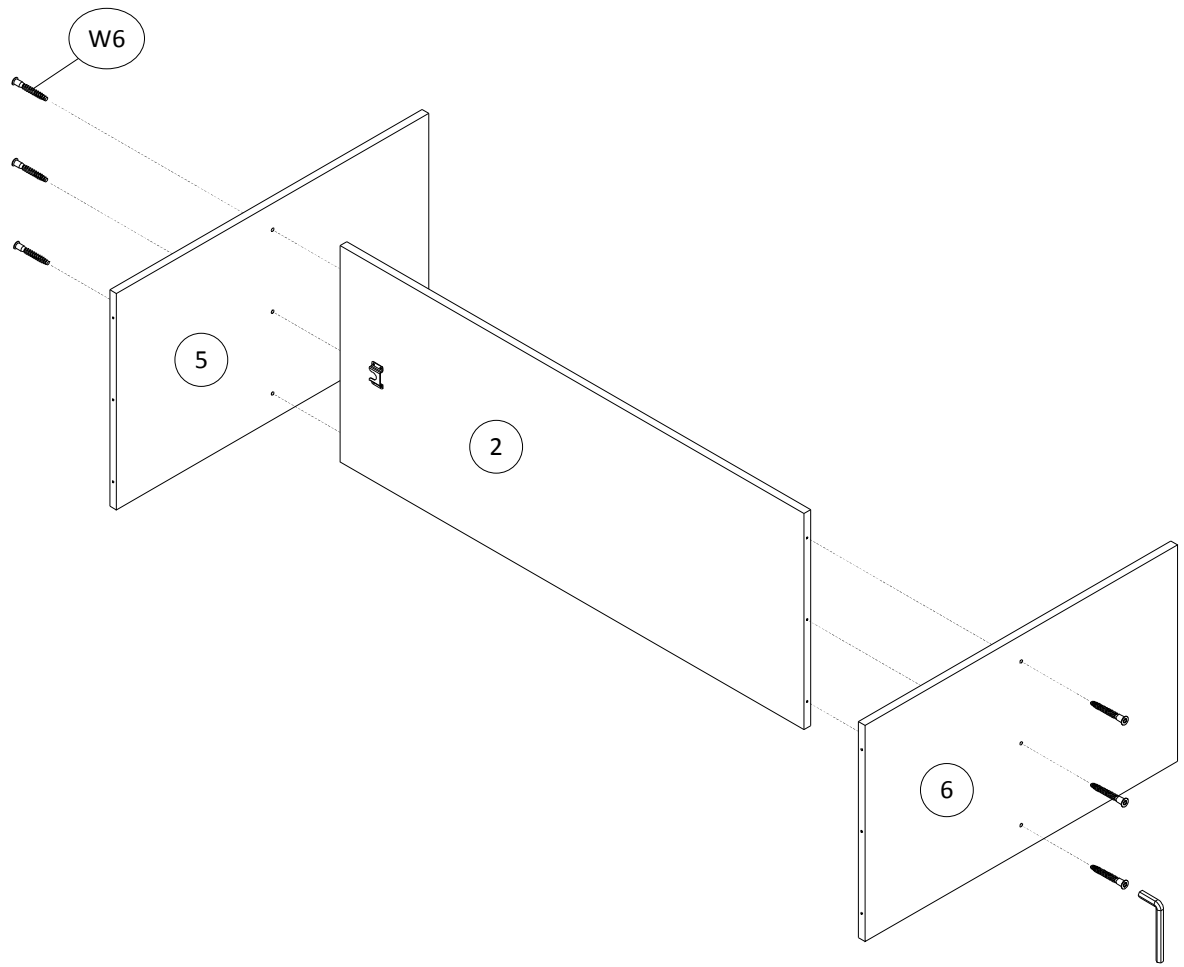

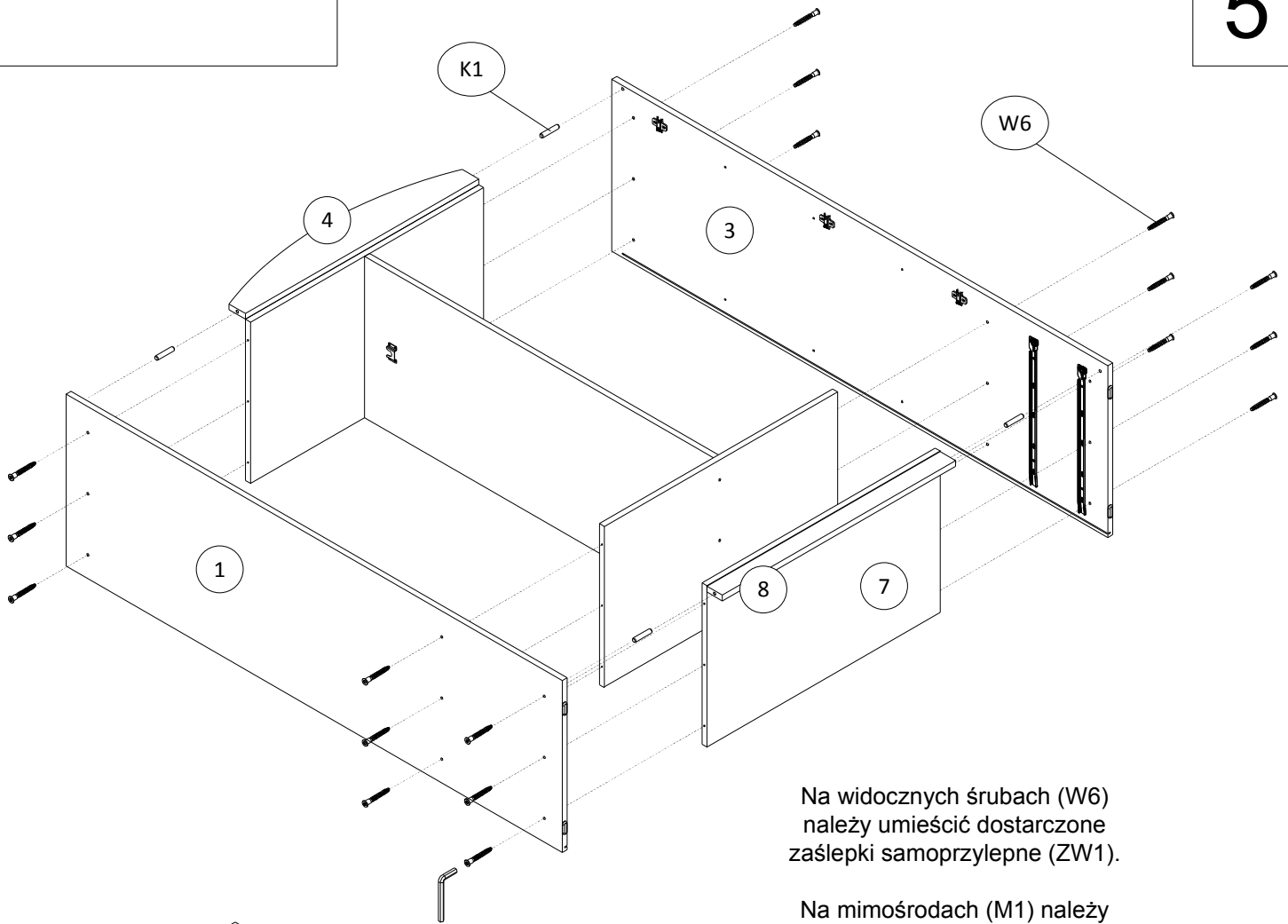

Na widocznych śrubach (W6) należy umieścić dostarczone zaślepki samoprzylepne (ZW1).

Na mimośrodkach (M1) należy umieścić dostarczone plastikowe zaślepki (ZM1).

On the visible screws (W6) should be placed supplied adhesive caps (ZW1).

On the eccentrics (M1) should be placed supplied plastic caps (ZM1).

