

LED MIRROR USE AND CLEANING INSTRUCTION

 In order to keep the LED mirror look perfectly, we suggest using and cleaning the mirror regularly.

1. Please use in a safe voltage range. (100V-120V)
2. Use electric tape to wrap around the wires to prevent leakage
3. Do not strike mirror glass with hard or pointed items.

 Please follow the procedures when you clean the mirror.

1. It is recommended that the product is cleaned with a soft, non abrasive cloth.
2. Do not use harsh cleaners or abrasive materials on any type of enamelled surface. Use the following cleaners to remove dirt.

Gentle liquid detergent.

Colorless cleanser.

★ Product Warranty

Manufacturer warranty for 1 year from date of purchase.

If you have any problem, please feel free to contact us.

LED Mirror Installation Instruction

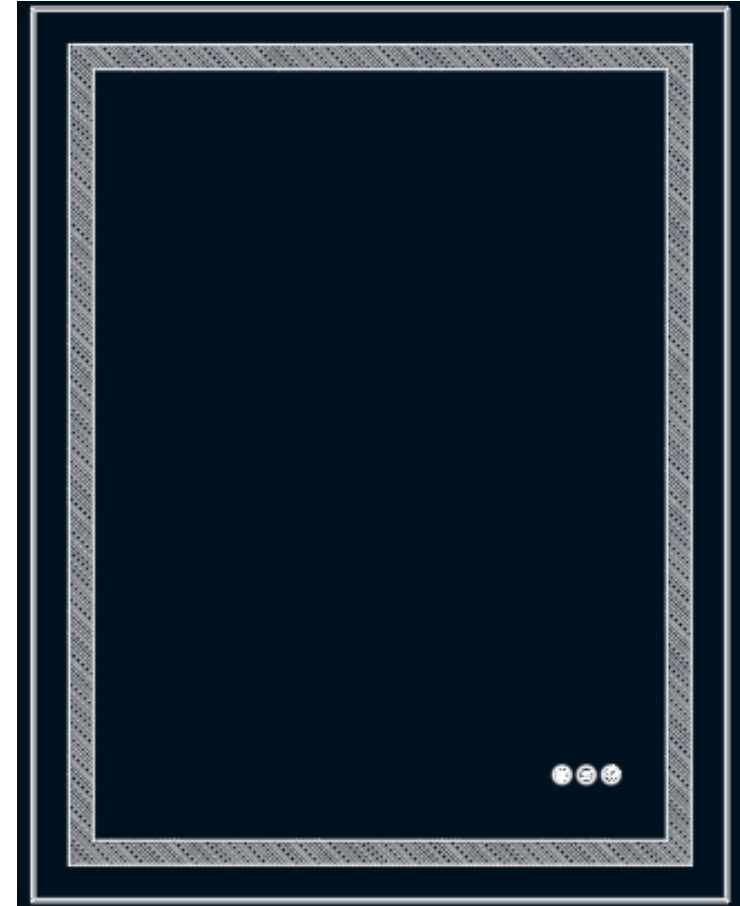

BEFORE INSTALLATION

 Thank you for using our products, please read these instructions carefully before installation in order to facilitate the use of the product.

1. Important Safety Instructions:

- Please read all instructions carefully before assembling the item.
- Assembly by two or more adults is highly recommended.
- To connect the wires to electrical junction box, a qualified technician or electrician is highly recommended.
- Disconnect power before installing, adding or changing any components.
- Ensure that the fixing location is able to take the weight of the complete fitting.
- To prevent injury, the mirror must be installed according to these instructions.

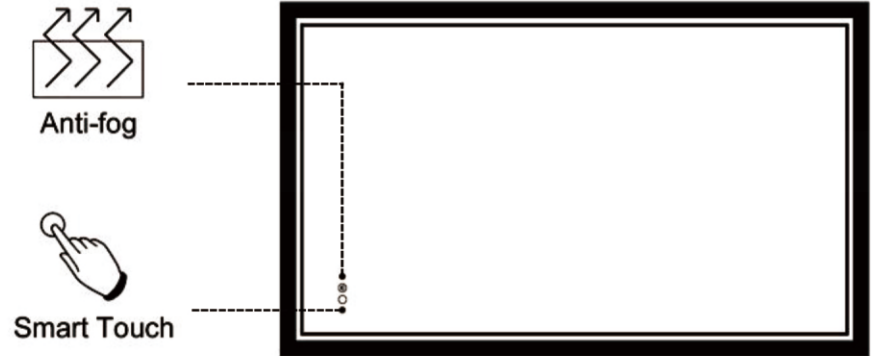

2. Pres-assembly:

- After opening the package, inspect the product immediately upon receipt for transit damage or missing parts.
- Keep the voltages between 100V and 120V. If the voltage exceeds 120V, please use transformer.
- You can connect the wires directly to your junction box or the plug. Do not remove the transparent silicone protector before completing the installation.



3. Before installation, please check and make sure the mirror is working properly:

After connecting the power, the two round buttons will turn white. At the moment the LED and anti-fog function are already turned on automatically. If you do not need to use any one of them, just touch it to off, then the button will be dimmed.

- ① The above button is the anti-fog switch.  In order to prevent wasting energy, the defogging function will automatically turn off after 1 hour.
- ② The below button is the smart switch. 

Tricolor Lights: This switch can control the light brightness and color temperature switching. Keep holding it and the brightness will change. You could adjust the color of light according to your preference: the first touch is white light, the second touch is yellow light, and the third touch is natural light. If no button is pressed within 15 seconds, pressing again will turn the light off immediately.

Single Color Lights: This switch can control the light brightness. Keep holding it and the brightness will change.

CONTACT US

Note: After opening the package, please inspect the product immediately for damage in transit or missing parts. If there is any missing, please contact us or you can contact us by following these steps:

- Open "Orders"
- Find the product you have purchased and open the product page
- Click Sold by "**Bathwiller**"-Click"Ask a question"
- Click"An order I have placed"
- Click "Your product"-Click "Other"-Click "Troubleshooting" Then you can send us messages, we will reply within 24 hours.

PACKING LIST

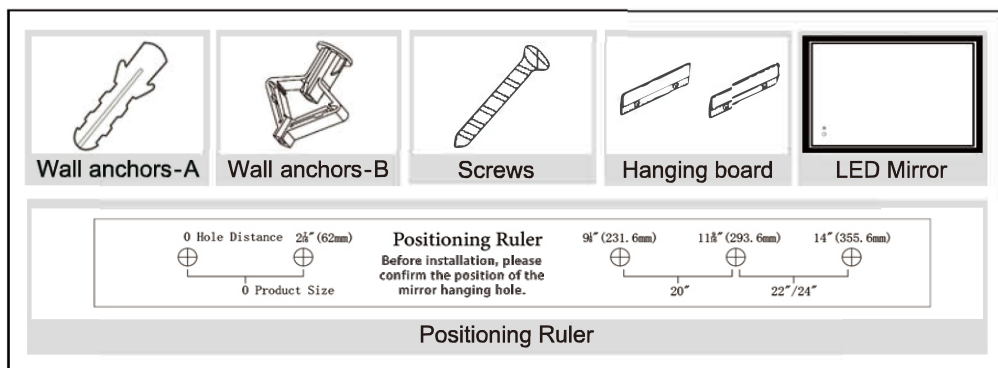

INSTALLATION TOOLS

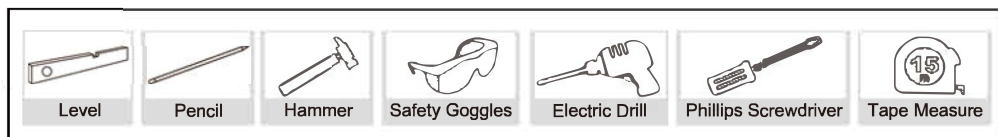

PRODUCT DESCRIPTION

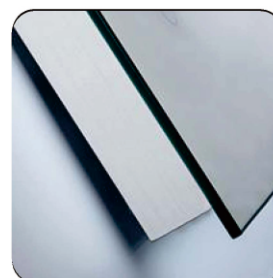

5mm Quality Mirror



Water-proof design

PRODUCT STYLE



Front tricolor lights
Front single color lights

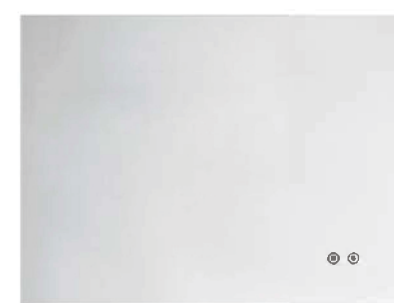

Back tricolor lights
Back single color lights

Mounting Method

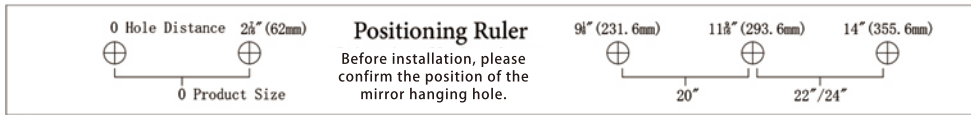

⚠ Note Before installation, please confirm the position of the mirror hanging hole.

The first line is the hole position distance. Before punching, please confirm that the hole position of the positioning ruler is consistent with the hanging hole of the product.

The second line is the product size. Find the position of the corresponding hole according to the product width of the selected suspension mode.

Choose the hanging method according to your preference, use the positioning ruler to confirm the position of the hanging hole, make sure it is horizontal, and use a marker to mark the hole positions ① ② ③ ④ on the wall.

⚠ Note: Please keep the proper distance from the mirror to the faucet.

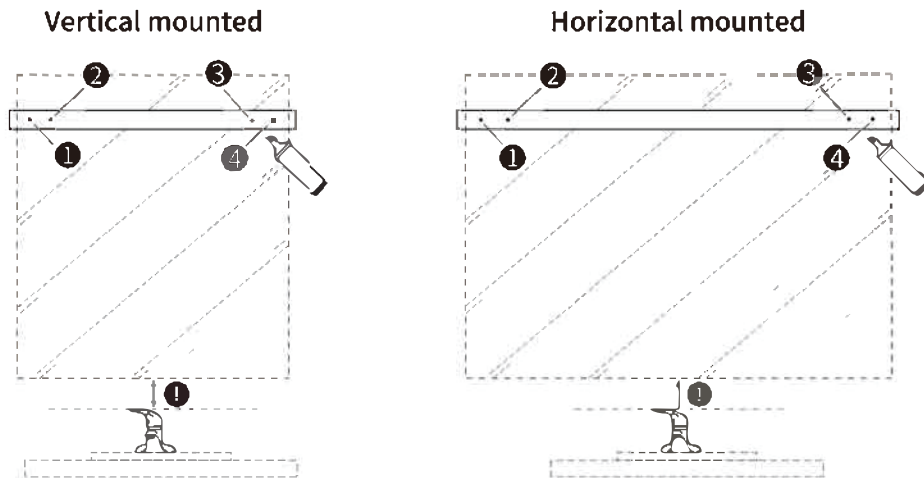

INSTALLATION OF LED MIRROR

Open the carton and make sure all the parts listed below are present.

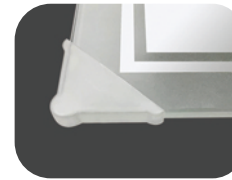

⚠ Note: Please don't remove the silicone corner protector before installation.

Drill pilot holes on the marked spots

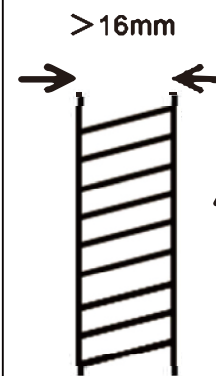

Use an electric drill to drill four 1/4" (6mm) holes at the marked spots, and then apply wall anchors-A with hammer. (1/4" (6mm) drill bit, drilling depth in 13v8z (50mm))

⚠ Note: Please wear goggles and pay attention to safety.

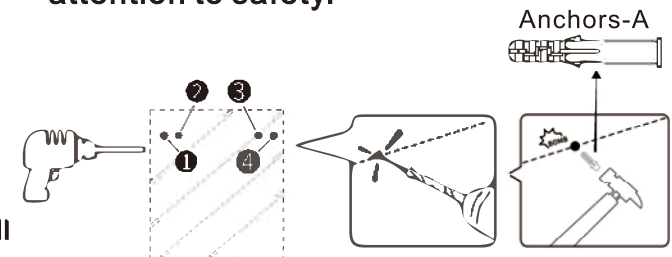

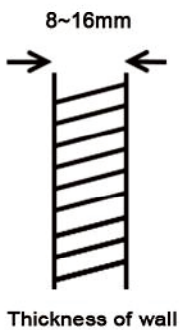

Use an electric drill to drill four 25/64" (10mm) holes at the marked spots, and then apply wall anchors-B with hammer. (25/64" (10mm) drill bit)

Note: Please wear goggles and pay attention to safety.



Thickness of wall

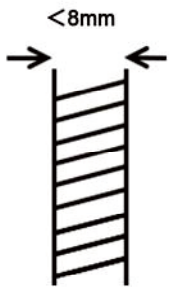

Unapplicable

Thickness of wall

Insert the screw

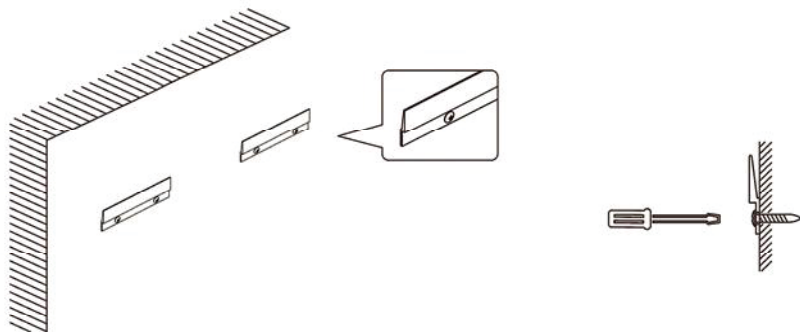

Screw the two hanging boards on wall.

Connect the power

Cut off the plug of the wire and peel off the outer layer. There are three power wires: A.live wire (Black) B.Neutral wire (White) C.Ground Wire (Green). You can connect the wires to standard switched lighting circuit.

Mount the mirror on the wall and ensure it is sturdy

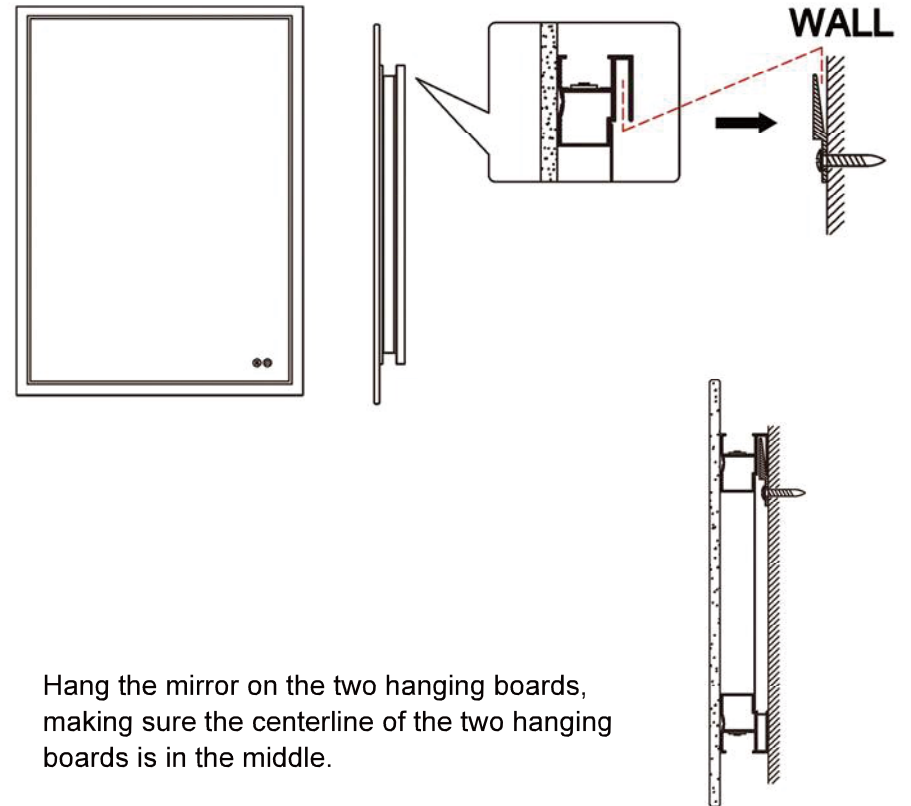

Hang the mirror on the two hanging boards, making sure the centerline of the two hanging boards is in the middle.

PRODUCT SPECIFICATION

Single color lights

Dimension	Watts	Lumens (front-lighted)	Lumens (backlit)
24"L x 32"W	48W	2900LM	3380LM
24"L x 36"W	48W	3172LM	3745LM
28"L x 36"W	48W	3432LM	3900LM

Tricolor lights

Dimension	Watts	Lumens (front-lighted)	Lumens (backlit)
24"L x 32"W	48W	4659LM	4729LM
24"L x 36"W	48W	5075LM	5151LM
28"L x 36"W	48W	5491LM	5573LM

PRODUCT SPECIFICATION

PARAMETER	SPECIFICATION
Color Temperature (Tricolor lights)	3000K-6000K
Color Temperature (Single color lights)	6000K
Input Voltage	AC100-120V
Output Voltage	12V DC
CRI	≧ 90 Ra
Working Temperature	-10~45 °C
Life Span	25000 hours
Anti-fog	Yes
Safety Compliance	ETL
IP Rate	IP44
Mirror Glass	5 mm
Wiring Method	Hardwired / Plug In
Switch	Touch Sensor Switch
Mounting Method	Wall Mount