

**\*\* Do not tighten any bolts until all of them have been started !**

Step 1.

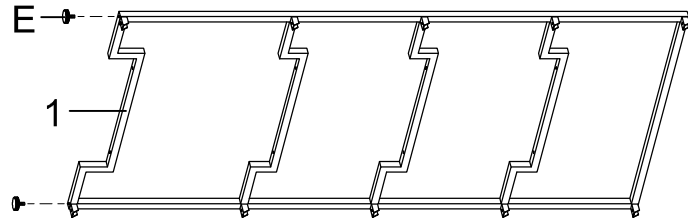

Step 2.

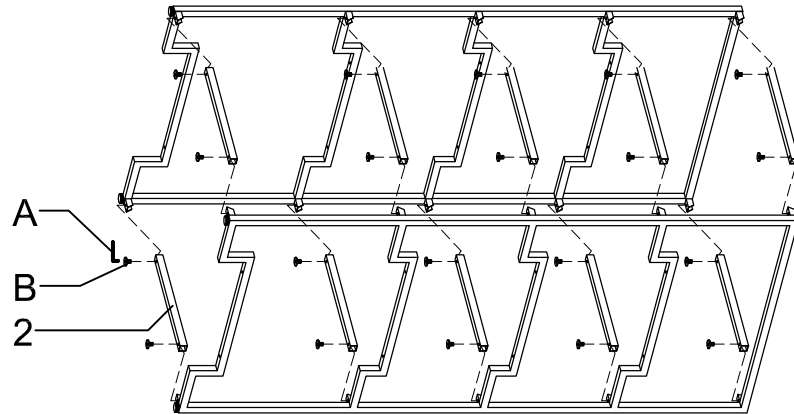

Step 3.

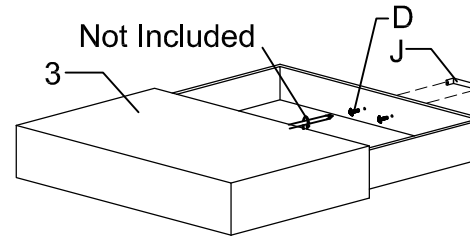



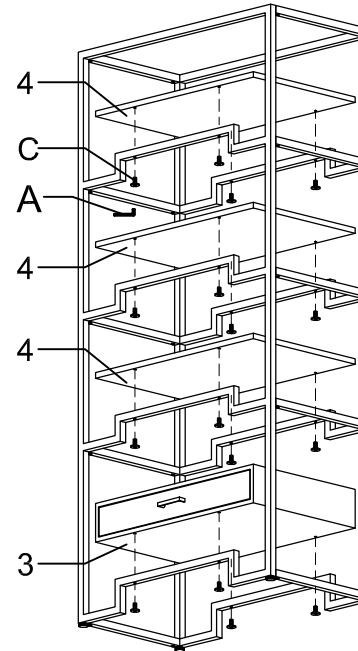



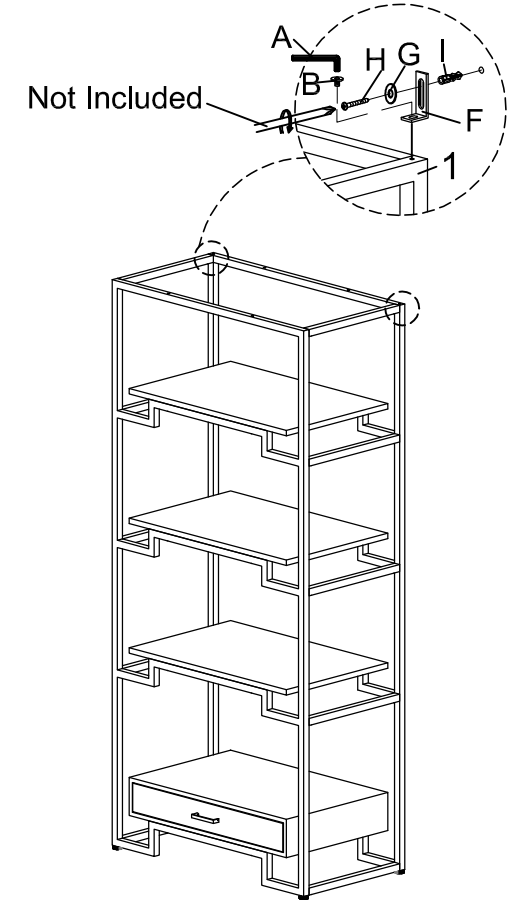

Step 4.

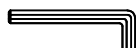

Step 5.

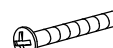

**ACCESSORY PACK**

<p>A</p>  <p>1PC</p>	<p>B</p>  <p>22PCS</p>	<p>C</p>  <p>16PCS</p>	<p>D</p>  <p>2PCS</p>	<p>E</p>  <p>4PCS</p>	<p>F</p>  <p>2PCS</p>	<p>G</p>  <p>2PCS</p>	<p>H</p>  <p>2PCS</p>	<p>I</p>  <p>2PCS</p>	<p>J</p>  <p>1PC</p>
---	---	---	--	---	--	--	--	--	---

**COMPLETE HARDWARE**

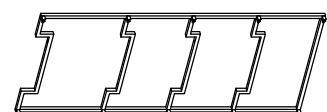
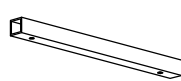
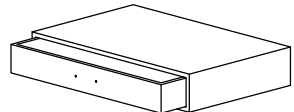
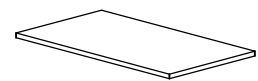
<p>1</p>  <p>2PCS</p>	<p>2</p>  <p>10PCS</p>	<p>3</p>  <p>1PC</p>	<p>4</p>  <p>3PCS</p>
--	---	---	--