

ASSEMBLY INSTRUCTION

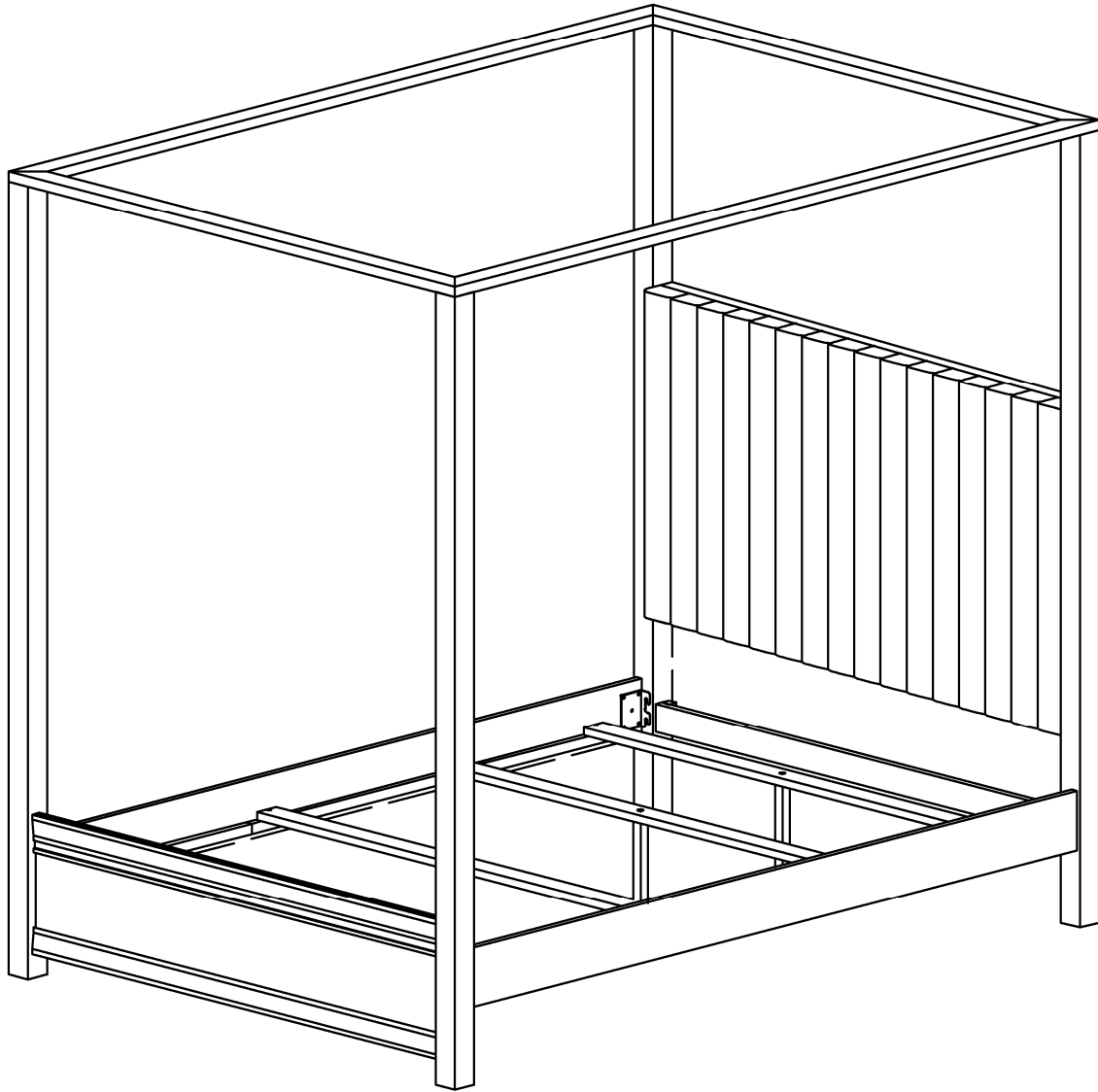





QUEEN BED



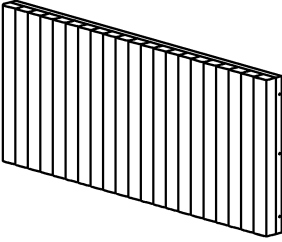
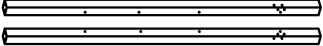
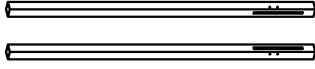



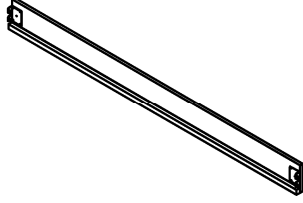
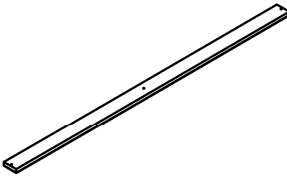

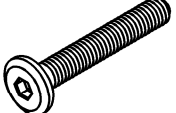

SAFETY WARNINGS

1. Always use the recommended size mattress or mattress support, or both, to help prevent the likelihood of entrapment or falls.
2. Do not allow horseplay on or under the bed and prohibit jumping on the bed.
3. Do not use substitute part. Contact the manufacturer or dealer for replacement part.
4. The use of water or sleep flotation mattresses is prohibited.
5. Keep these instruction for future reference.
6. Strangulation Hazard - Never attach or hang items to any part of the bed that are not designed for use with the bed, for example, but not limited to hooks, belts and jump ropes.

ASSEMBLY INSTRUCTION QUEEN BED

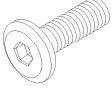
1	2	4	5
 Headboard panel 1pc	 Headboard Post 2pcs  Footboard Post 2pcs	 Support bar 1pc	 Footboard panel 1pc
6	8	9	10
 Long canopy 2pcs  Short canopy 2pcs	 Side rails 2 pcs	 Slats 4 pcs	 Support legs 4 pcs

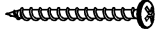
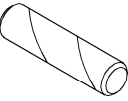
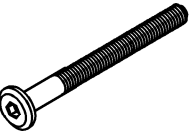
HARDWARE & ILLUSTRATION

A	B	C	D
 Ø1/4" x L44 mm Allen Head bolts 20 pcs	 Allen Key 1 pc	 Ø1/4" Flat Washer 12 pcs	 Ø1/4" Lock Washer 12 pcs
E	F	G	H
 Ø5/16" x L20 mm Allen Head bolts 8pcs	 Ø5/16" Flat Washer 8 pcs	 Ø5/16" Lock Washer 8 pcs	 Ø4 x L30 mm Screws 8 pcs
K	L	M	
 Ø8 x 30 mm Wood dowel 4 pcs	 Ø1/4" x 65mm Hex-Head bolts 4 pcs	 Ø1/4" x 10mm Horizontal-Hole bolts 4 pcs	

ASSEMBLY INSTRUCTION QUEEN BED

STEP 3

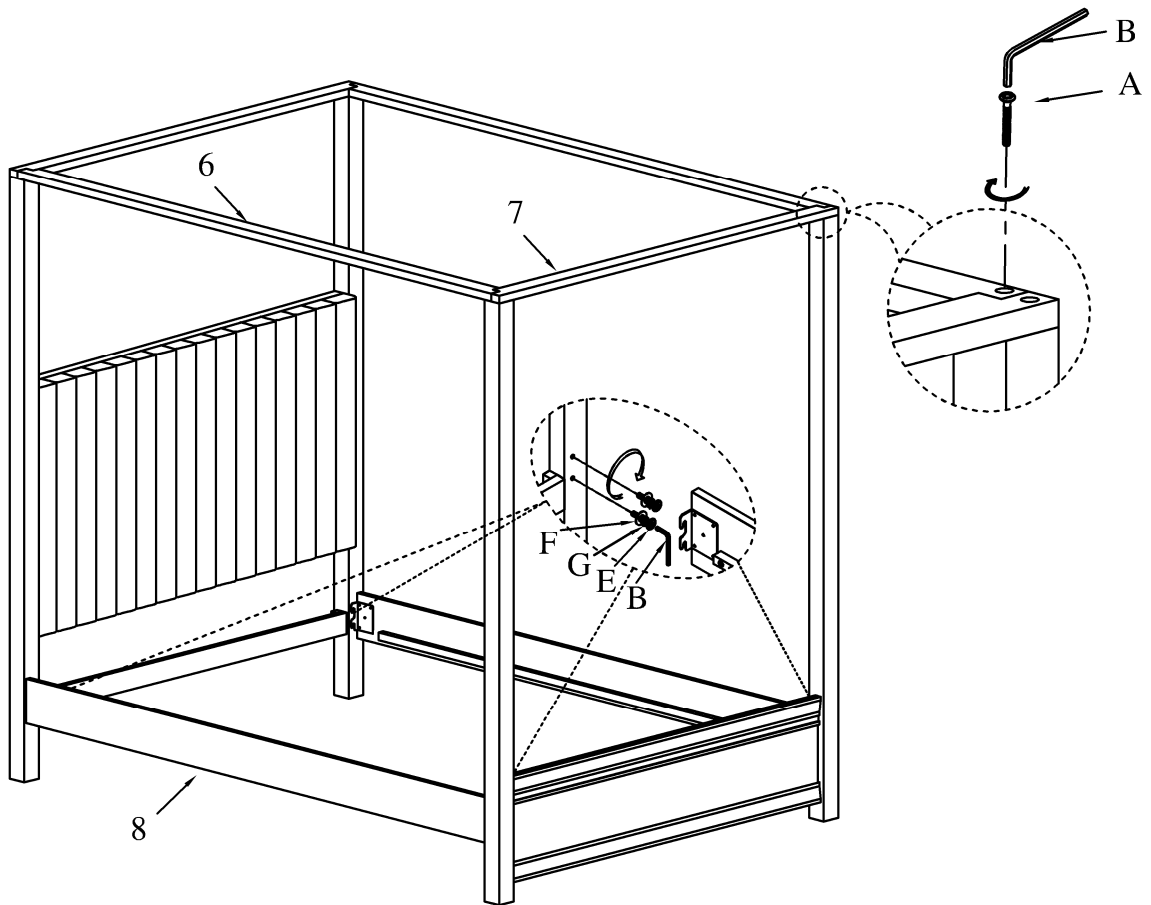

STEP 4

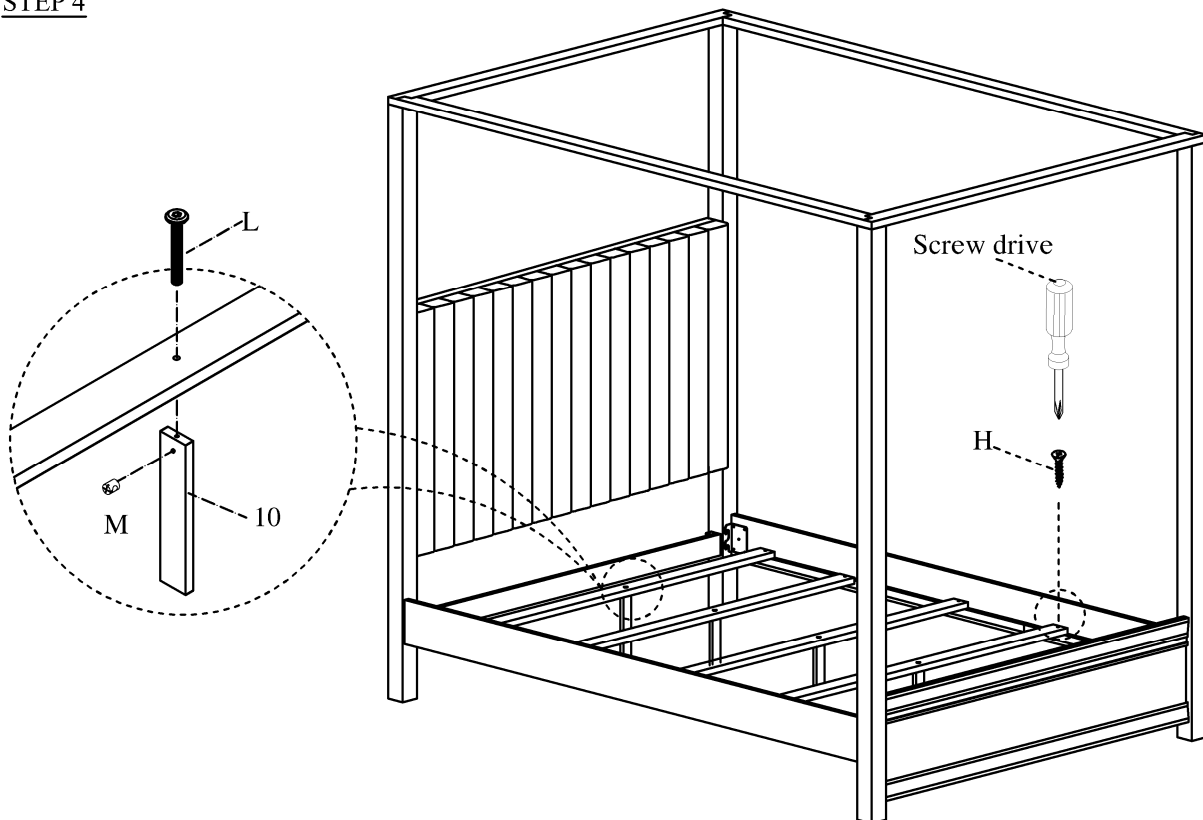

ASSEMBLY IS NOW COMPLETE AND THANKS FOR YOUR PURCHASE