



















 (A1) 8x30mm x3	 (B) x6	 (B1) 6,3x50mm x6
 (J9) 128mm x1	 (E7) 4*16mm x4	 (E3) 3*20mm x13
 (E5) 3,5*16mm x16	 (R) x1	 (E15) 4*22mm x2
 (K1) x4	 (H2) x8	 (E17) 4*35mm x2
 (D1) 16mm x6	 (D) x6	 (C1) 5x30mm x6
 (E6) 4*14mm x4	 (L3) x2	 (J1) x8
 (O1) x5		 (Y7) x2

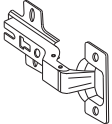

No	a*b	x
1L+1R	464x310	1+1
2	464x294	1
3	600x311	1
4	600x311	1
5	220x290	2
6	428x326	1
7	478x235	1
8	235x347	1

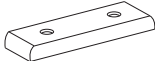
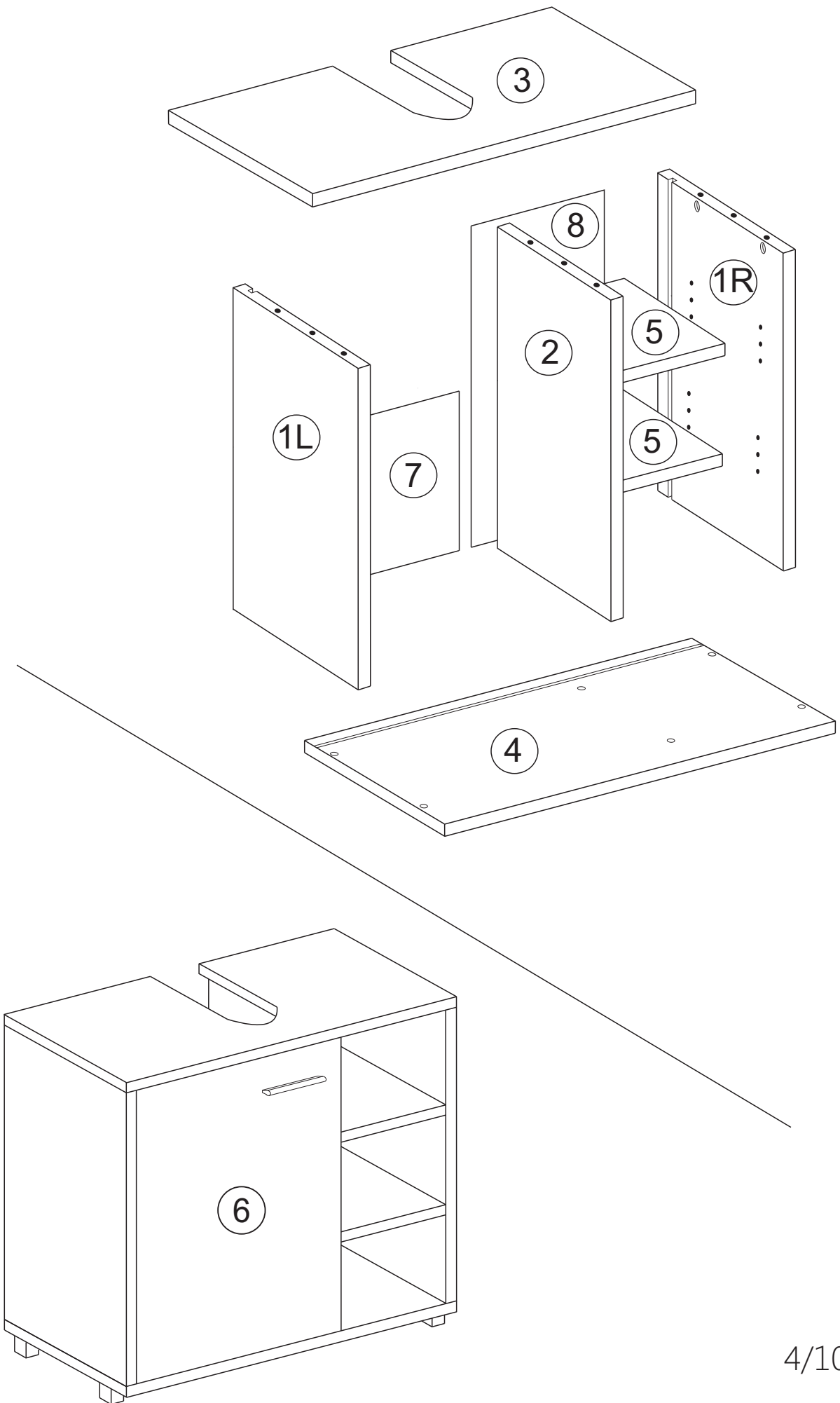
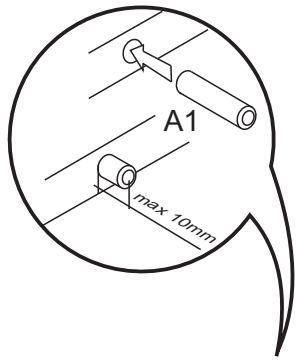



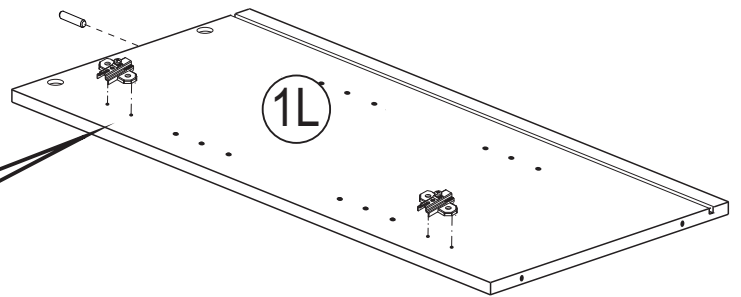
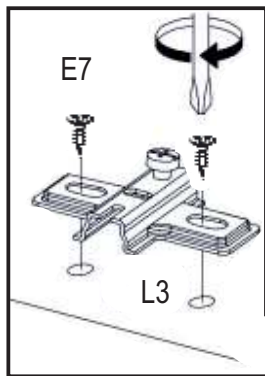
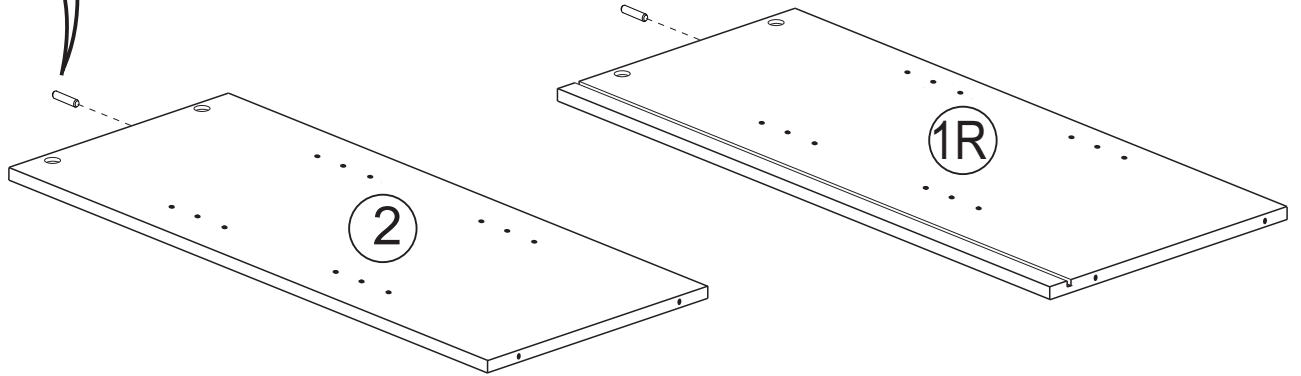

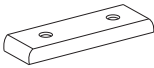
		
<b>A1</b> 8x30mm x3	<b>E7</b> 4*16mm x4	<b>L3</b> x2

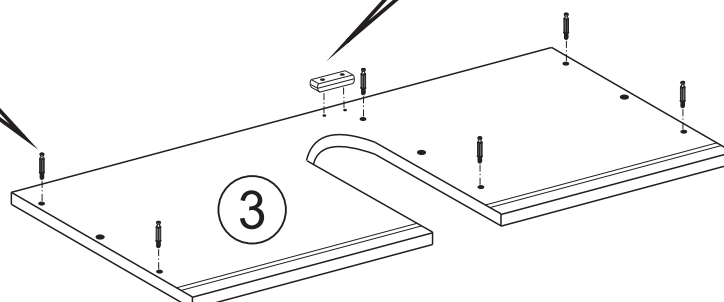
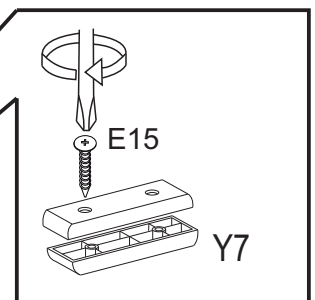
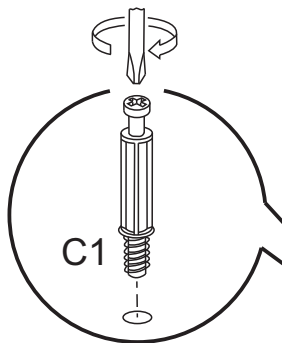

		
<b>C1</b> 5x30mm x6	<b>Y7</b> x2	<b>E15</b> 4*22mm x2



D1		16mm	x6	D		x6
----	---	------	----	---	---	----

