

# CB2485U



<b>Product family</b>	Refrigerator
<b>Installation</b>	Built-in
<b>Category</b>	Bottom mount
<b>No-frost system</b>	Total
<b>Cooling type</b>	Fan-assisted refrigerator, no-frost freezer
<b>Defrost</b>	Automatic
<b>Hinge</b>	Door-to-door
<b>Hinge position</b>	Right
<b>Reversible door</b>	Yes
<b>EAN code</b>	8017709306045



## Aesthetic



<b>Material</b>	Steel	<b>Glass shelf profile color</b>	Silver
<b>Side material</b>	Steel	<b>Display</b>	LED
<b>Logo</b>	Silkscreened	<b>Display position</b>	Internal
<b>Door shelf profile color</b>	Silver		

## Refrigerator compartment features



<b>No. of adjustable shelves</b>	3	<b>Low temperature compartment</b>	Yes
<b>Number of fruit and vegetables drawers</b>	2	<b>Refrigerator lighting</b>	Yes
<b>Type of adjustable shelves</b>	Glass	<b>Refrigerator lighting</b>	LED
<b>Crisper cover</b>	Yes		

## Refrigerator Inner Door

<b>Number of adjustable door shelves</b>	2	<b>No. of bottle shelves</b>	1
--	---	------------------------------	---

## Other Refrigerator features



---

Accessories	Egg tray	Fan	Yes
-------------	----------	-----	-----

## Freezer features

---

Number of drawers	3
-------------------	---

## Other Freezer features

---



Accessories	1 x ice box	Fast-freezing compartment	Yes
-------------	-------------	---------------------------	-----

## Other technical features

---



Display functions	Holiday, Fast-freezing, Fast-cooling, ECO
Fast-freezing button	Yes
Power-on light	Yes
Door open alarm	Yes
Temperature setting type	Electronic
No. of compressors	1
Refrigerant gas type	R600a
Foam agent	Cyclopentane

## Performance / Energy Label NEW

---

Noise level	40 dB(A) re 1pW
-------------	-----------------

## Electrical Connection

---



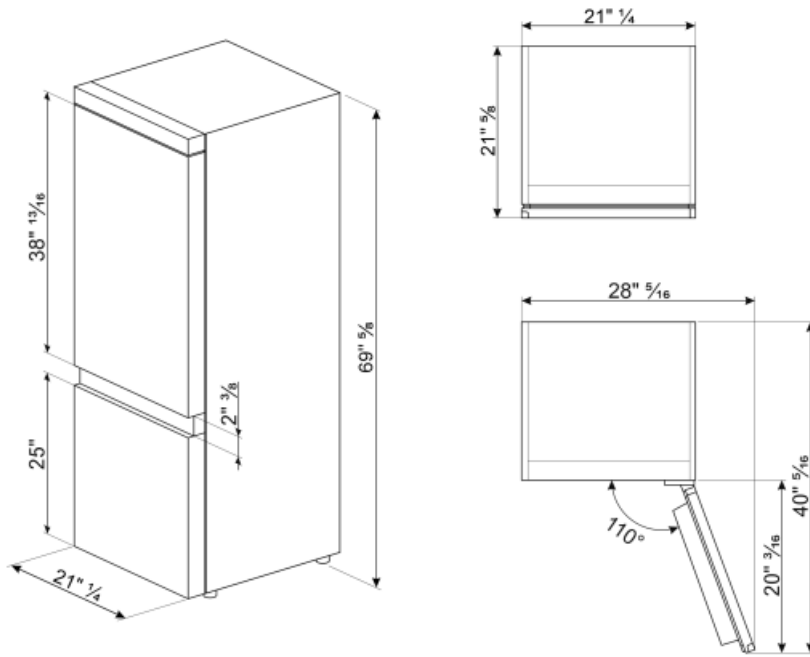





Plug	(A) USA & Mexico	Voltage (V)	115 V
Electrical connection rating	160 W	Frequency (Hz)	60 Hz
Current	0.4 A	Power cord length	70 7/8 "



---

## Symbols glossary (TT)

---

	The automatic defrost system works by automatically defrosting at regular intervals eliminating the need to defrost altogether.		LED display: to show programmes, functions and options selected and the time to the end of the cycle.
	Economical mode: Analyzes fridge functioning during the activation and optimizes the operating cycle in order to reduce power consumption.		Ventilated: Forced distribution of cold air in the refrigerator compartment, which allows even temperature distribution within the fridge.
	Fast freezing: The fast freezing function brings the temperature of the compartment down when activated a few hours prior to usage.		Power saving mode: The power saving mode allows you to disable the refrigerator and keep the freezer working.
	LED interior lighting: is a more energy efficient and long lasting way of illuminating the interior of the appliance.		No Frost: The No Frost and Frost free systems prevent ice from forming so that no defrosting is required.