

BATHLYN

**Installation Manual**

# BATHLYN

<b>1. Tools &amp; Parts List</b>	_____	<b>01</b>
<b>2. Installation Instructions</b>	_____	<b>02</b>
<b>3. Adjustment of Drawer</b>	_____	<b>03</b>
<b>4. Adjustment of door</b>	_____	<b>04</b>
<b>5. User Maintenance</b>	_____	<b>05</b>
<b>6. Care &amp; Maintenance for countertop</b>	_____	<b>06</b>
<b>7. Cabinet Warranty and care &amp; Maintenance</b>	—	<b>07</b>

## Tools & Parts List

### Cabinets

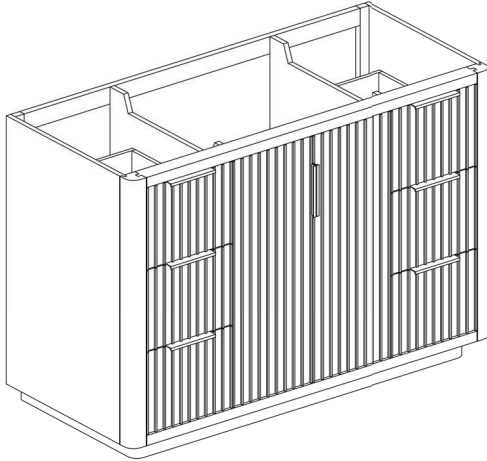

### Backsplash

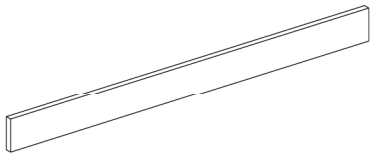

### Basin

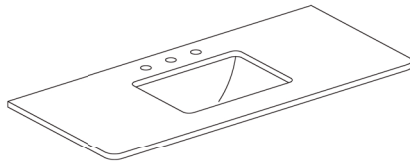

01

## Installation Instructions

- 1** Secure the countertop and backsplash to the vanity with silicone

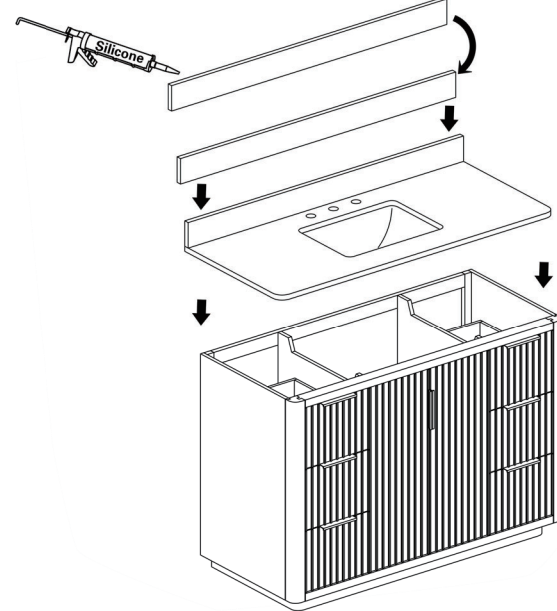

- 2** Wait 24 hours before use.

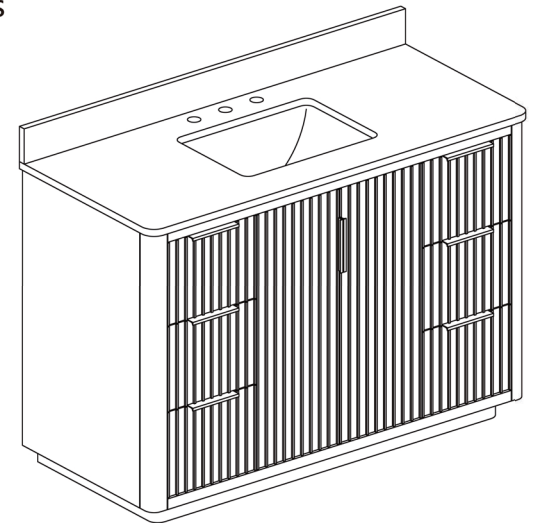

02

## Adjustment of Drawer

1

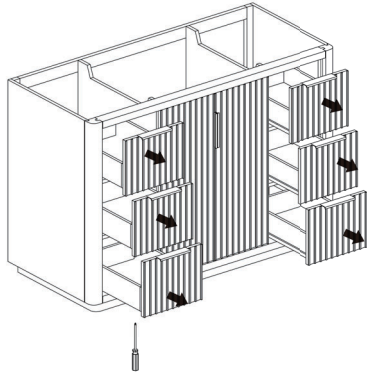

2

Drawer Removal (if applicable)

1. Remove

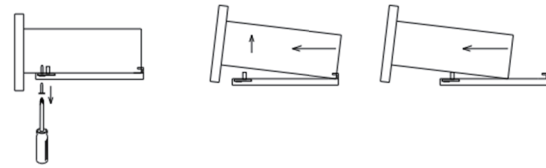

2. Install

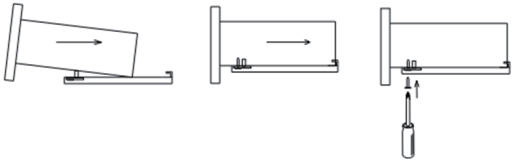

3

Up and down adjustment.

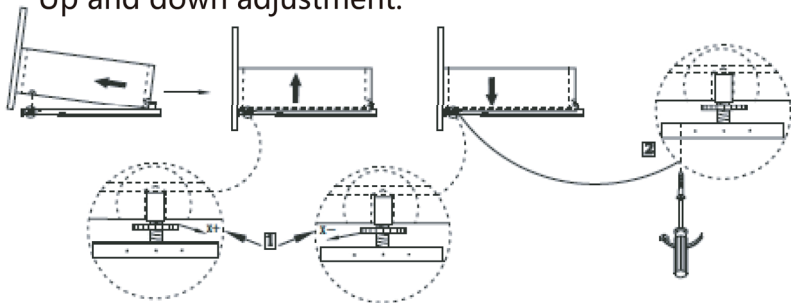

03

## Adjustment of door

4

Left and right adjustment.

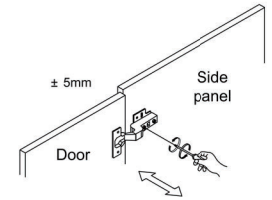
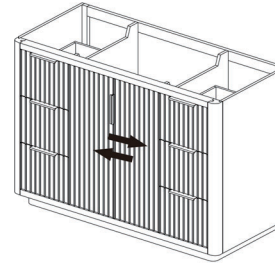

5

Front and back adjustment.

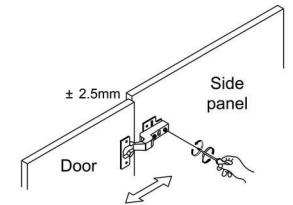
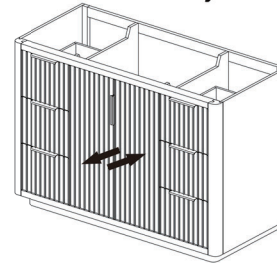

6

Up and down adjustment.

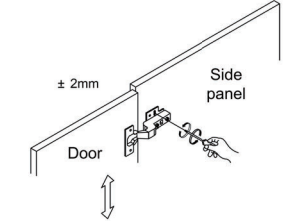
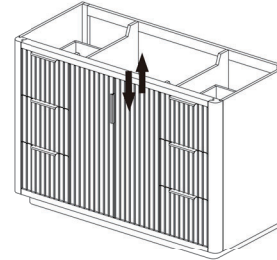

7



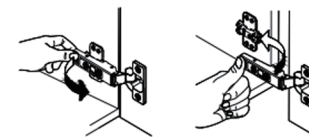





















To remove or install the hinges:



remove

Install

04

<p><b>KEEP CABINET AWAY FROM WATER, which will cause deformation and damage.</b></p> <p><b>CAUTION</b>   </p>	<p><b>DO NOT put lit cigarettes on the counter or basin, which will cause discoloration.</b></p> <p><b>CAUTION</b>   </p>
<p><b>DO NOT pour acid or alkaline solutions into the basin, which will cause discoloration, leak or damage.</b></p> <p><b>CAUTION</b>   </p>	<p><b>AVOID DIRECT SUNLIGHT, which may cause deformation and discoloration.</b></p> <p><b>CAUTION</b>   </p>
<p><b>AVOID HEAT, which will cause deformation and discoloration.</b></p> <p><b>CAUTION</b>   </p>	<p><b>DO NOT pour hot water into the basin, which may cause damage.</b></p> <p><b>CAUTION</b>   </p>
<p><b>AVOID nylon brush, toilet cleaner or hydrochloric acid cleaner, which will cause damage</b></p> <p><b>CAUTION</b>   </p>	<p><b>AVOID dropping hard objects into the basin, which may cause damage.</b></p> <p><b>CAUTION</b>   </p>

**To extend the life of the product, please do the maintenance work every day. The following maintenance methods are for reference only.**

- Please dry the cabinet immediately with clean, soft cloth when it encounters water.
- When the product is stained with dirt, wipe the cabinets clean with a soft, damp cloth, apply some cleaners, and dry immediately with another clean, soft cloth.
- The water supply pipes, the drainage pipes, and the connection parts are prone to water leakage under different circumstances. Please check these parts regularly to avoid accidents due to water leakage.
- After the product is used for a period of time, dirt will remain on the drain plug, which will affect drainage, so the plug needs to be cleaned regularly.

# Care & Maintenance for countertop

- For every day cleaning use a soft sponge or dishcloth with warm water.
- For stubborn or greasy clean-ups use a PH neutral liquid cleaner such as Mr. Clean, 409, Simple Green, Fantastic etc. or ordinary dish washing detergent e.g. Palmolive with warm water applied with a soft sponge or dishcloth.
- For any persistent staining issues, Bon Ami, Bar Keepers Friend or Soft Scrub products without bleach can be applied first to a wetted sponge or dishcloth, and then applied to the countertop surface. Please note that an aggressive use of more abrasive non-chemical cleaners can result in the dulling of the quartz surface.
- To sanitize a quartz surface, a 70% isopropyl rubbing alcohol solution can be used or a Lysol Disinfectant spray.
- Avoid using sponges that contain aluminum oxide (the same abrasive in sand paper) as it may dull quartz's finish.
- Though most common household cleaners have no effect of quartz, never allow your quartz countertop to come in contact with drain cleaners, paint strippers, acetone or products containing Hydrofluoric acid, Ammonia, Methylene chloride, Trichloroethylene or any product with a very high or very low PH. These types of chemicals may etch or discolor the surface of the quartz.
- While quartz countertops are resistant to scratches, scuffs, stains and burns, these surfaces are not damage-proof. Homeowners must take care to avoid exposing quartz countertops to permanent inks, markers or dyes, as these substances may not be removable. If a countertop is marked by a permanent marker or dye, rinse the area with water as soon as possible, then apply a cleansing product if the stain is still visible. Clean the area again with water after applying the cleanser.
- Although quartz is resistant to stains from juice, wine, coffee and other food substances, it is best to wipe up spills immediately to prevent possible stains.
- There is no need to seal your quartz countertop. Unlike natural stone products which have porous surfaces, quartz countertop is non-porous, meaning that any sealer applied will not penetrate beyond the surface of the material. Eventually the sealer may start to wear off unevenly in high use areas causing the polish to appear inconsistent.
- Quartz countertop can be damaged by direct exposure to heat. When cooking, use trivets or heating pads to guard the countertop surface against direct exposure to hot cookware or coffee pots.
- Avoid using metal knives and utensils directly on the countertop, as metal may scratch the quartz. When chopping vegetables, slicing bread or preparing other foods with sharp utensils, use a cutting board to prevent scratches.
- Brushed, honed or concrete finishes by nature of their textured surface may require daily cleaning in order to maintain a pristine appearance. These alternate finishes have an increased surface texture and as a result may show more surface markings as a result of normal day to day activities. Markings caused as a result of normal use of the countertop will be only on the surface and should be easily removable by use of any the approved cleaners or cleaner types mentioned above. Over the lifetime of your brushed, honed or concrete finish surface, constant daily use may result in the development of a patina which will be unique to each installation.

# **Cabinet Warranty and care & Maintenance**

---

**All Bathlyn products carry a one-year manufacturer's warranty from the date of purchase.**

- Warranty covers defects in materials and workmanship in the product.
- Proof of purchase & warranty claims must be submitted to the place of purchase.
- **Please note that the warranty will be void if:**
- Damage caused by improper use, unauthorized or unreasonable modification
- Damage caused by carelessness or negligence during installation
- Damage caused by dirt or gravel
- Damage caused by harsh chemicals or cleaning solutions
- Damage caused by natural disaster
- Failed to present proof of purchase.

**We reserve the right to repair product using parts or technicians or replace items at our own discretion.**

## **Thank you for your purchase!**

We appreciate your business and know you will enjoy your product for many years to come.

If you have any questions, require technical assistance or have any problems with your product,

We will be glad to assist you .

Please contact our customer service team 1-844-688-2284 or [info@bathlyn.com](mailto:info@bathlyn.com)

To learn more about our products, please visit: [www.bathlyn.com](http://www.bathlyn.com).

Sincerely

The Bathlyn Team