

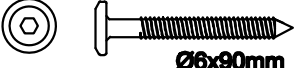

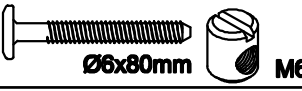



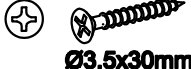

A	 Ø8x30mm	52
B	 Ø6x90mm	2
C	 Ø6x80mm M6	12
D	 Ø6x25mm	8

E	 Ø3.5x30mm	94
F		1
G	 Ø7x50mm	4
H	 Ø6x70mm	2

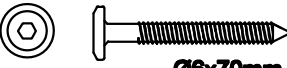
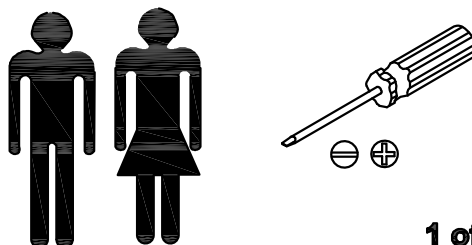
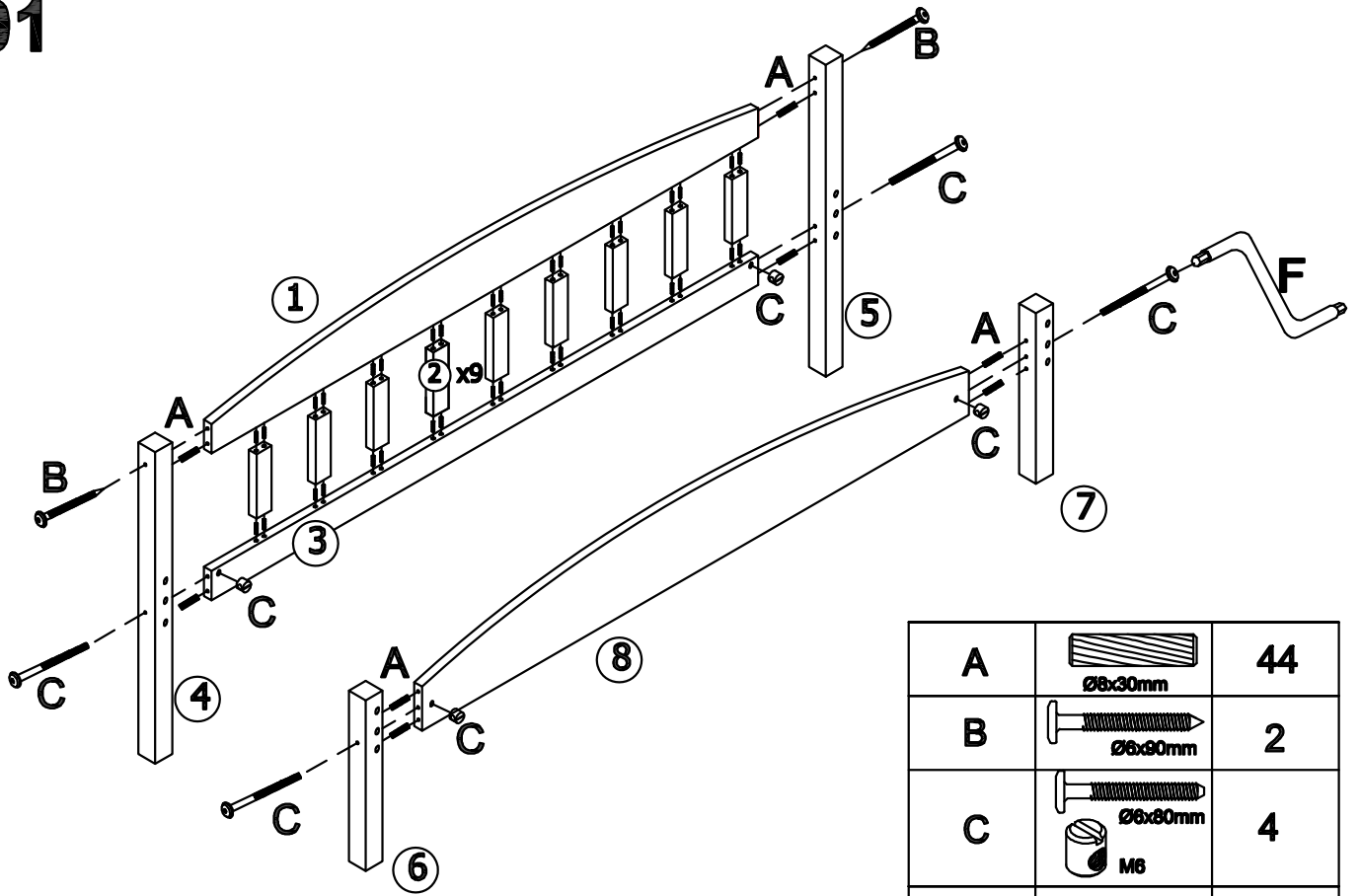



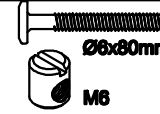

01

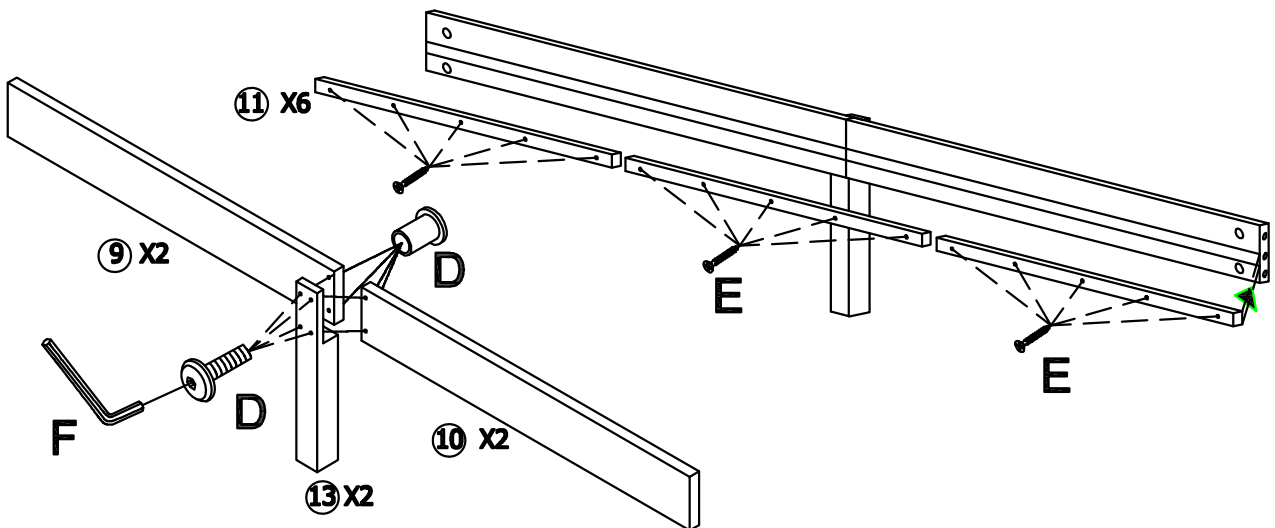

A	 Ø6x30mm	44
B	 Ø6x90mm	2
C	 Ø6x90mm M6	4
F		1





02

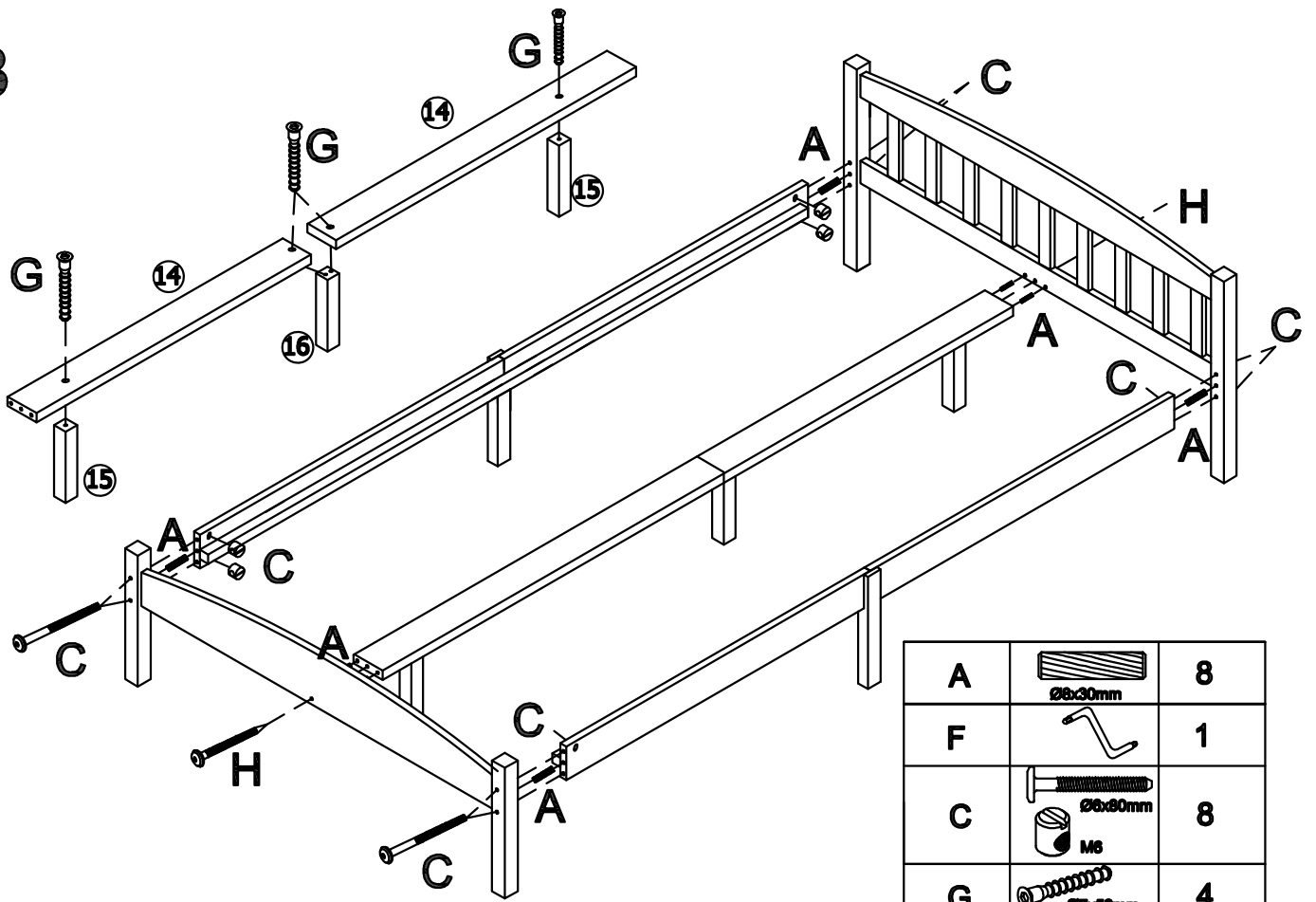

D		8
E	 Ø3.5x30mm	30
F		1

03



A	 Ø6x30mm	8
F		1
C	 Ø6x80mm M6	8
G	 Ø7x50mm	4
H	 Ø6x70mm	2

04

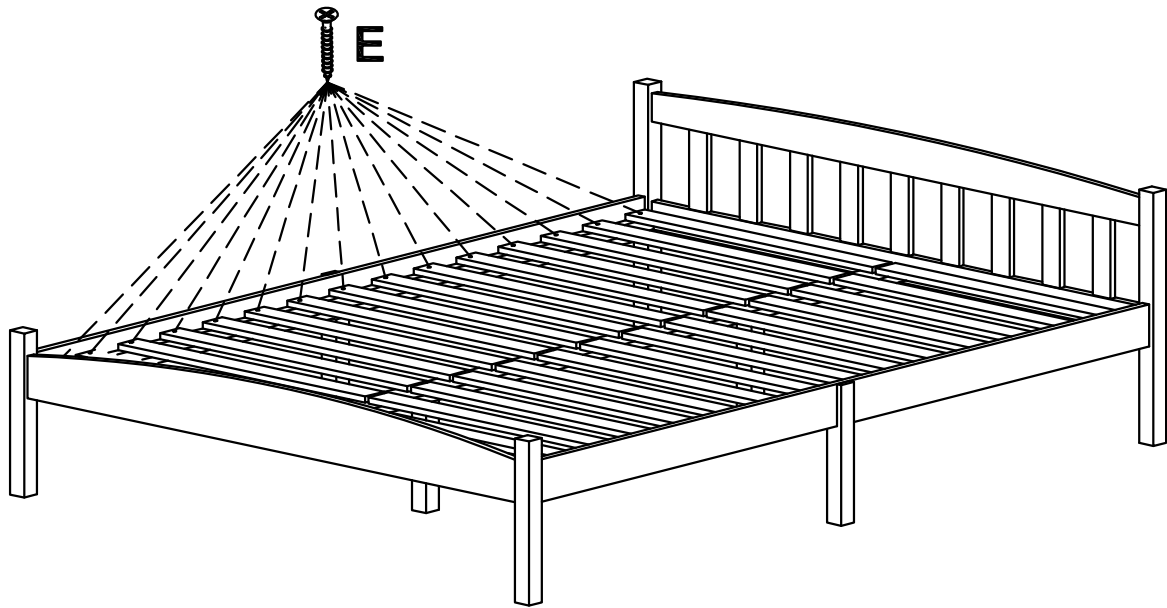

E	 Ø3.5x30mm	64
---	--	----