

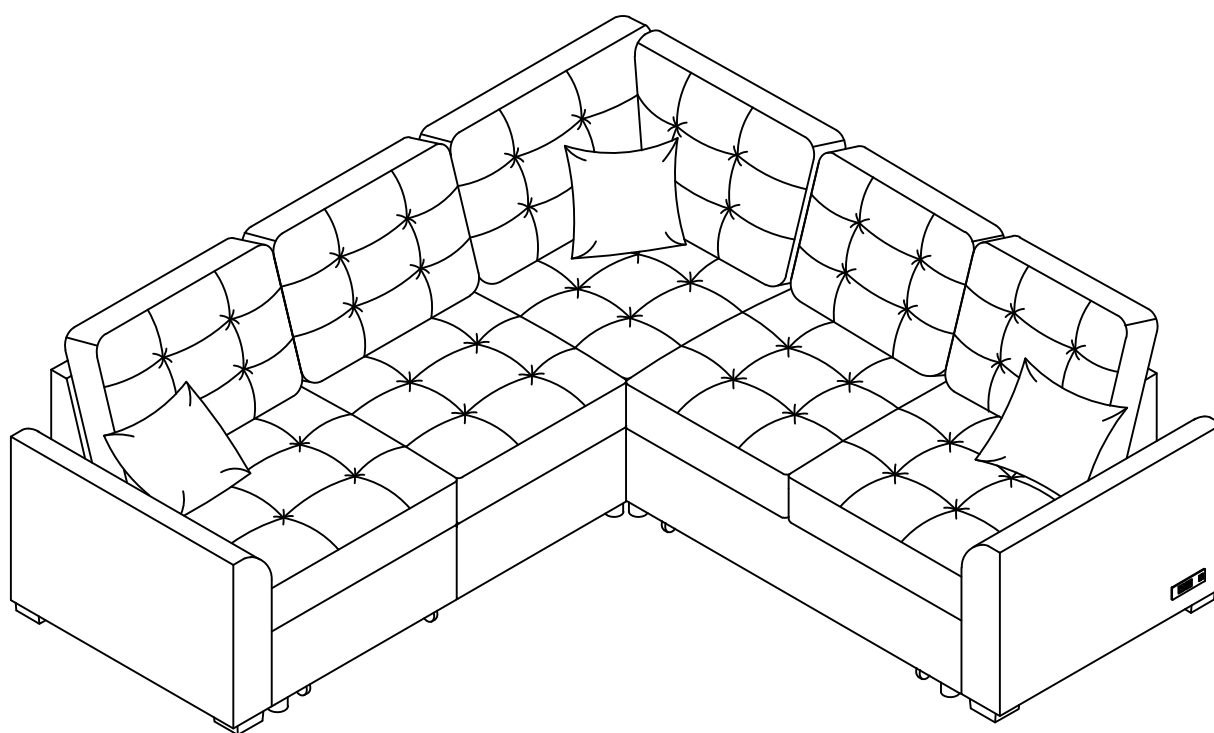

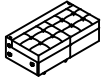

# ASSEMBLY INSTRUCTION





ITEM NO.: WF311428-WF311429-WF311430-WF311431  
N719P175258-N719P175259-N719P175260-N719P175262





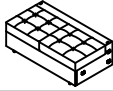



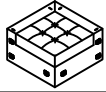

**WF311428 / N719P175258 -COMPONENT LIST**

NO.	DRAWING	QTY	DESCRIPTION
B		1	Loveseat Body
E		1	Corner short Back Frame
I		4	Round legs
K		3	Back Cushion



**WF311429 / N719P175259-COMPONENT LIST**

G		1	Chair Body
C		1	Loveseat Back Frame
J		1	Chair Back Frame
N		3	Pillow
I		4	Round legs

**WF311430 / N719P175260-COMPONENT LIST**

D		1	Corner Frame
F		1	Corner Long Back Frame
K		1	Back Cushion
L		1	Corner Long Back Cushion
M		1	Corner Short Back Cushion
I		4	Round legs
O		4	Square Leg
P		8	Bolt
G		1	Allen key

**WF311431 / N719P175262-COMPONENT LIST**

A		1	Left Arm
H		1	Right Arm

# PARTS LIST

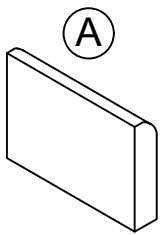
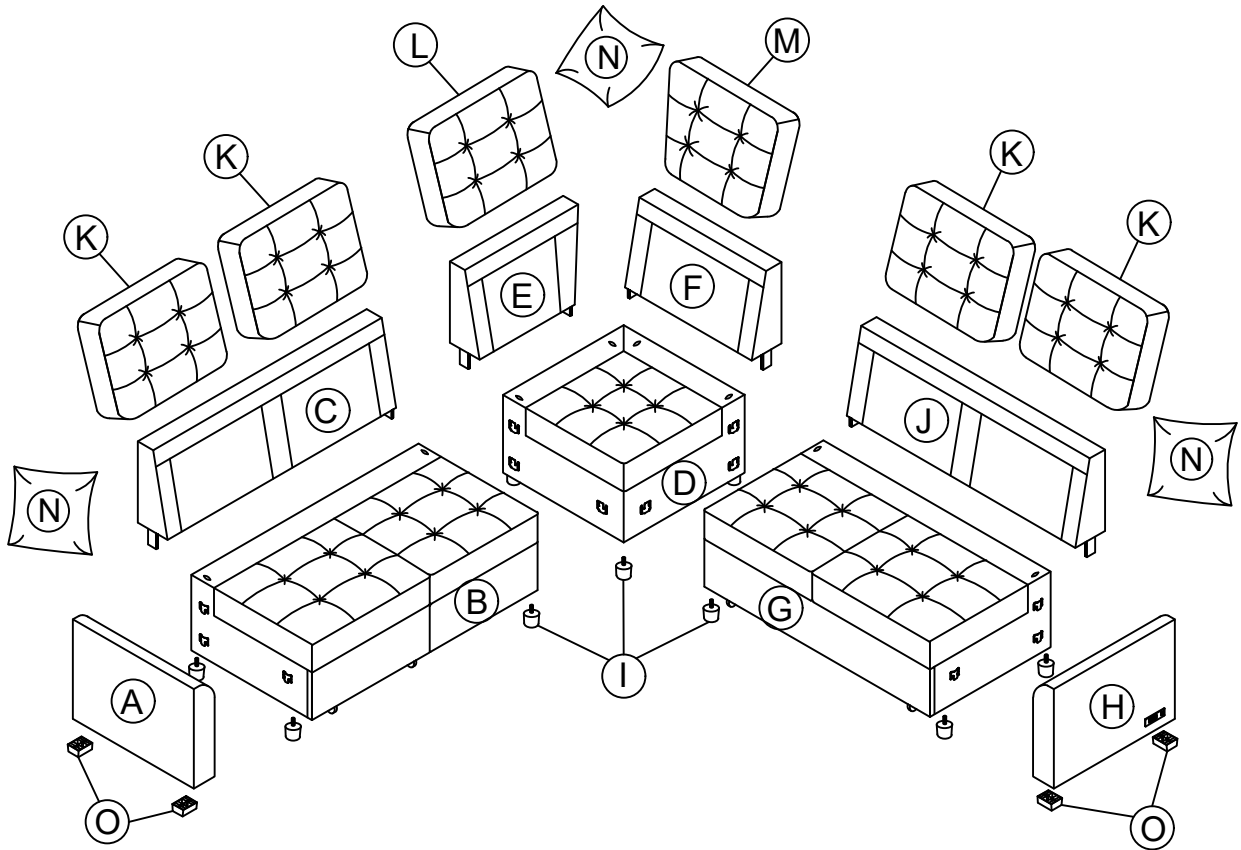

**A**  
Left Arm  
X 1PC

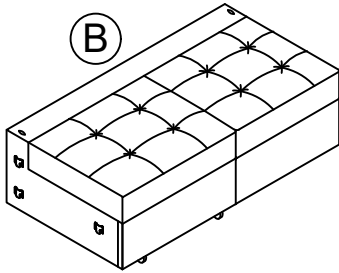

**B**  
Loveseat Body  
X 1PC

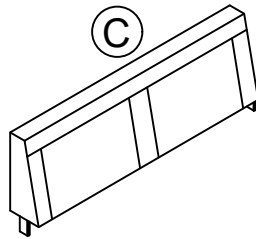

**C**  
Loveseat Back Frame  
X 1PC

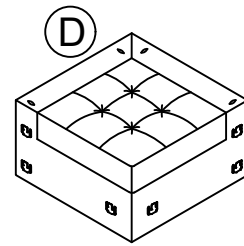

**D**  
Corner Frame  
X 1PC

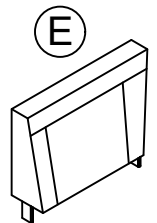

**E**  
Corner Short Back  
Frame X 1PC

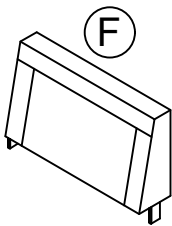

**F**  
Corner Long Back  
Frame X 1PC

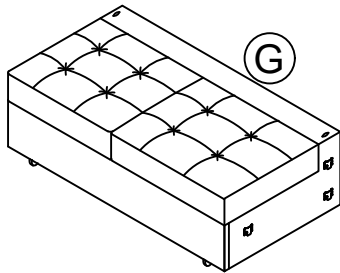

**G**  
Chair Body  
X 1PC

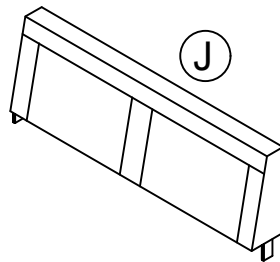

**J**  
Chair Back Frame  
X 1PC

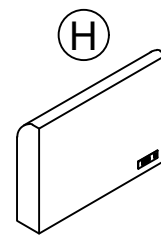

**H**  
Right Arm  
X 1PC

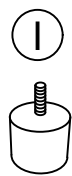

**I**  
Round Leg  
X 12 PCS

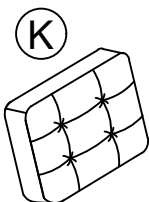

**K**  
Back Cushion  
X 4PCS

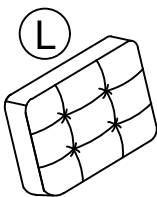

**L**  
Corner Long  
Back Cushion  
X 1PC

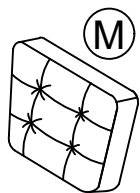

**M**  
Corner Short  
Back Cushion  
X 1PC



**N**  
Pillow  
X 3PCS

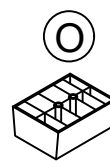

**O**  
Square Leg  
X 4PCS

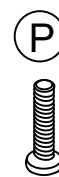

**P**  
Bolt 5/16"X50mm  
X 8PCS



**G**  
Allen key  
1PC

### STEP 1:

- 1.1 Attach I x4 to B x1
- 1.2 Attach I x4 to D x1
- 1.3 Attach I x4 to G x1.

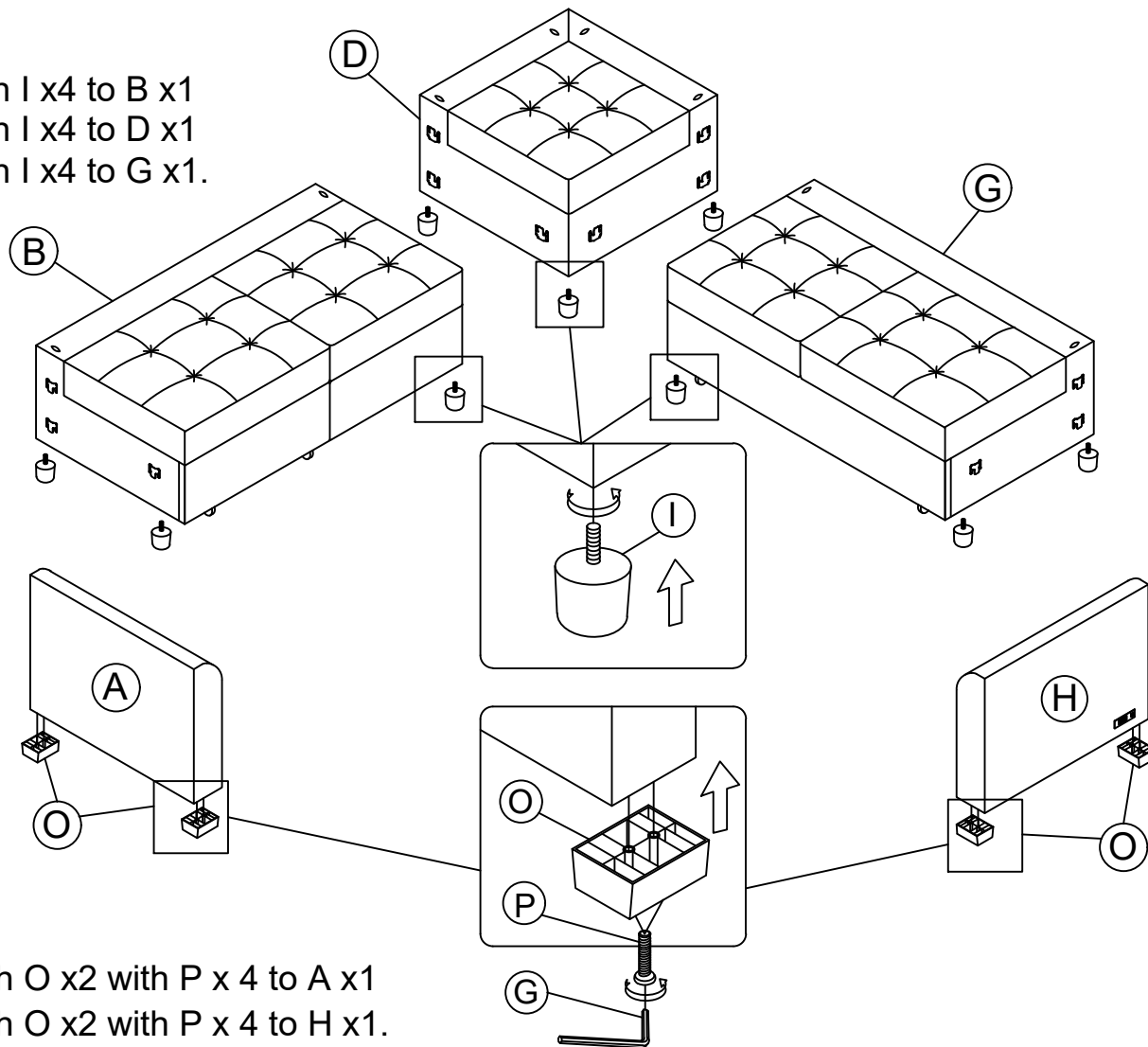

### STEP 2:

- 2.1 Attach O x2 with P x 4 to A x1
- 2.2 Attach O x2 with P x 4 to H x1.

### STEP 3:

- 3.1 Attach C x1 to B x1
- 3.2 Attach E x1 with F x1 to D x1
- 3.3 Attach J x1 to G x1.

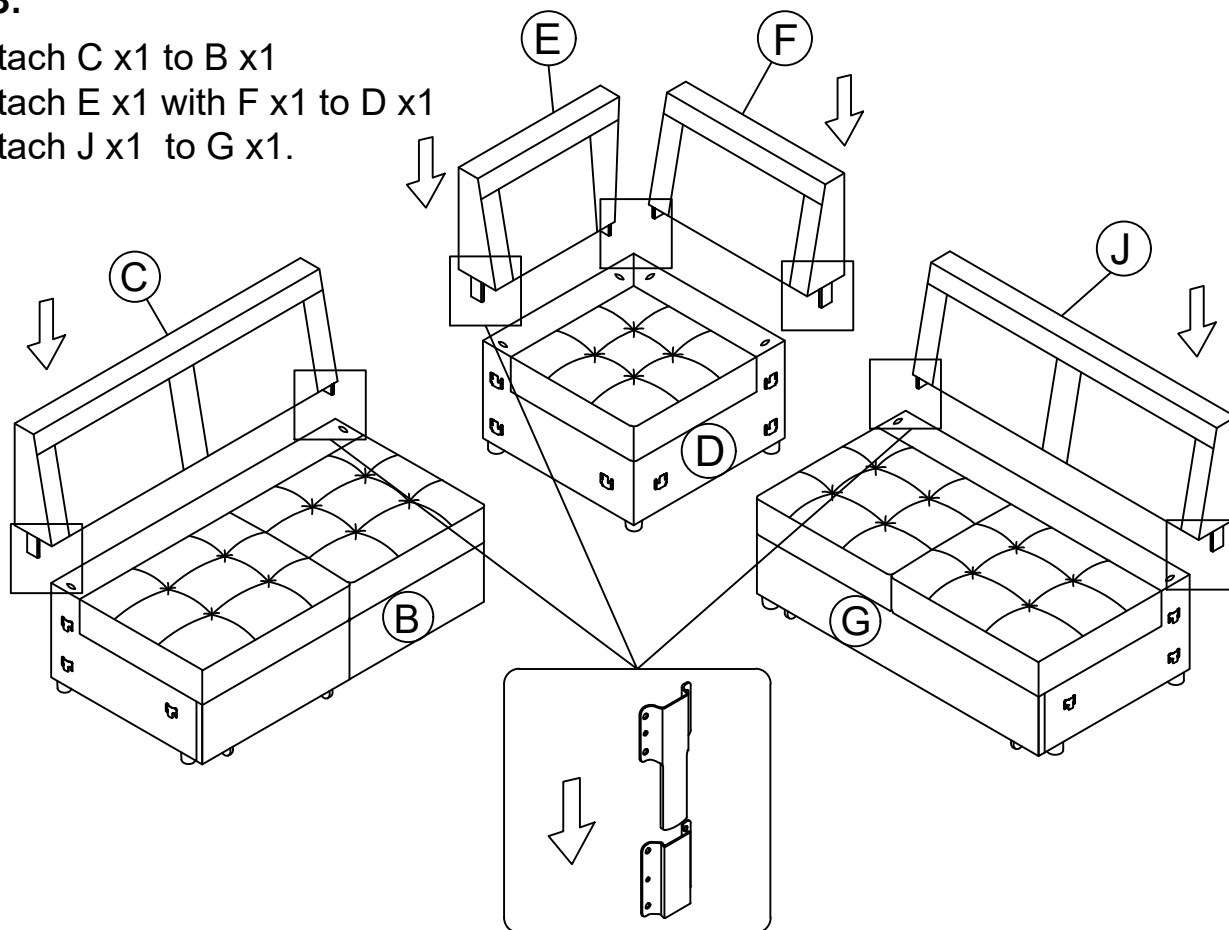

## STEP 4:

- 4.1 Attach B x1 to A x1 with D x1
- 4.2 Attach G x1 to H x1 with D x1.

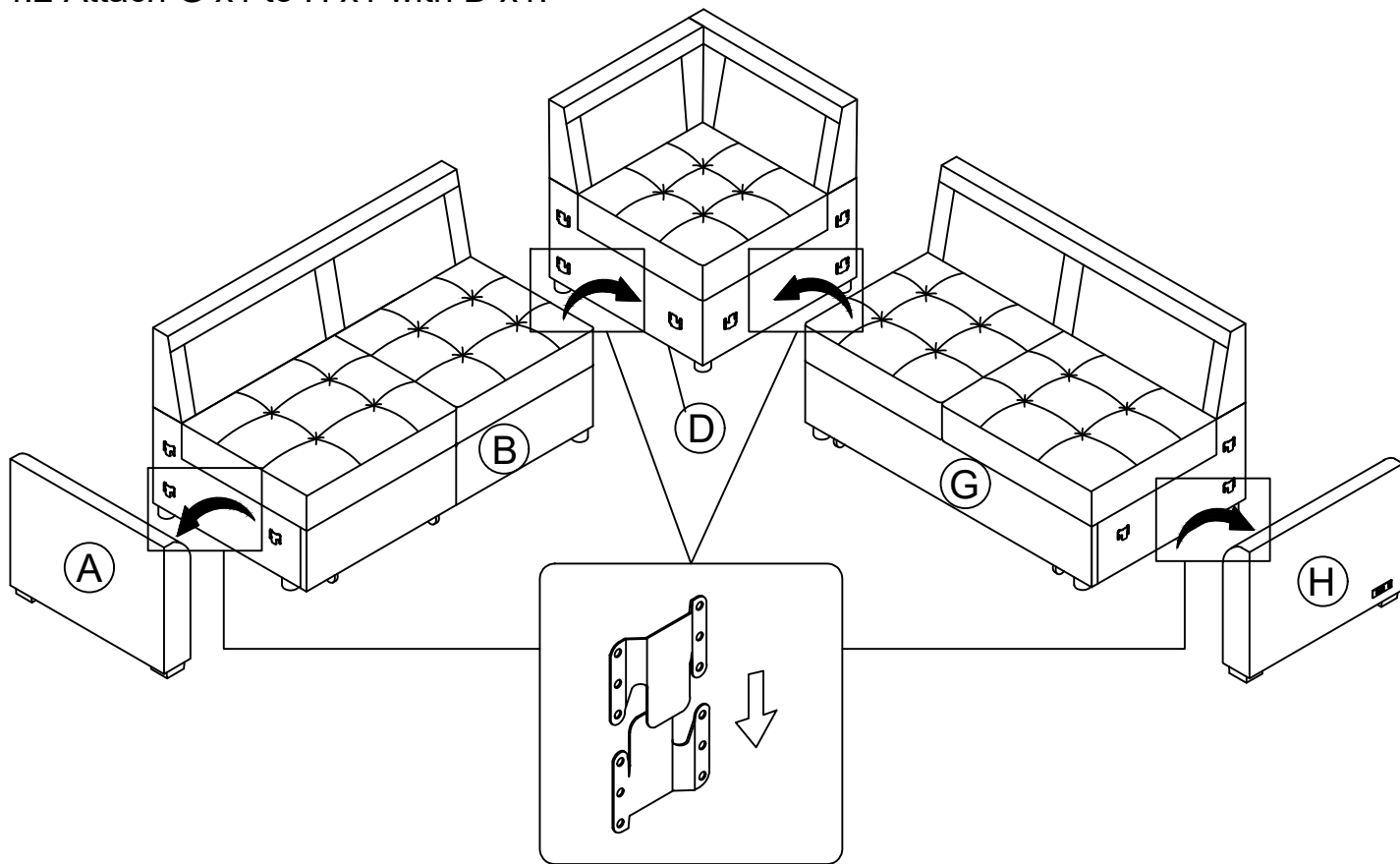

## STEP 5:

- 5.1 Attach K x4 to C x1 with J x1
- 5.2 Attach L x1 to E & M with F.

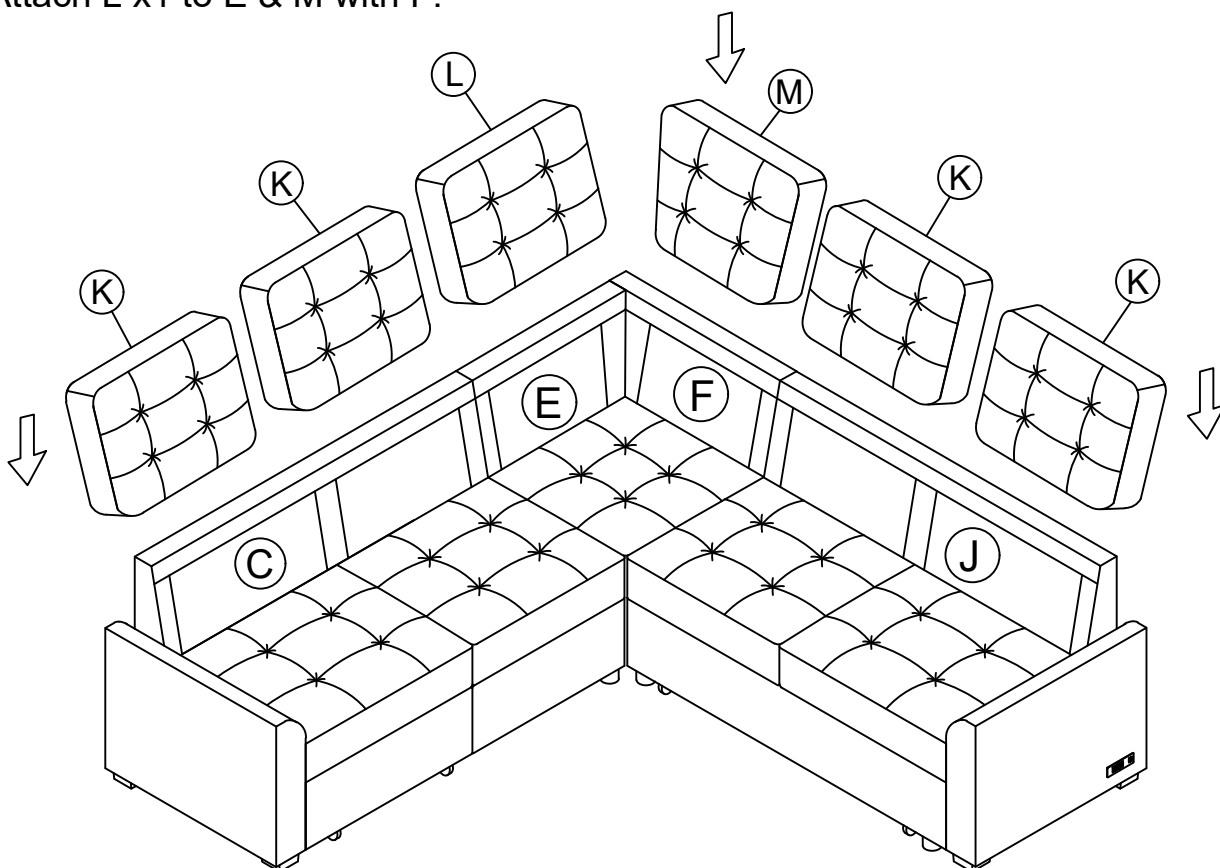

## STEP 6:

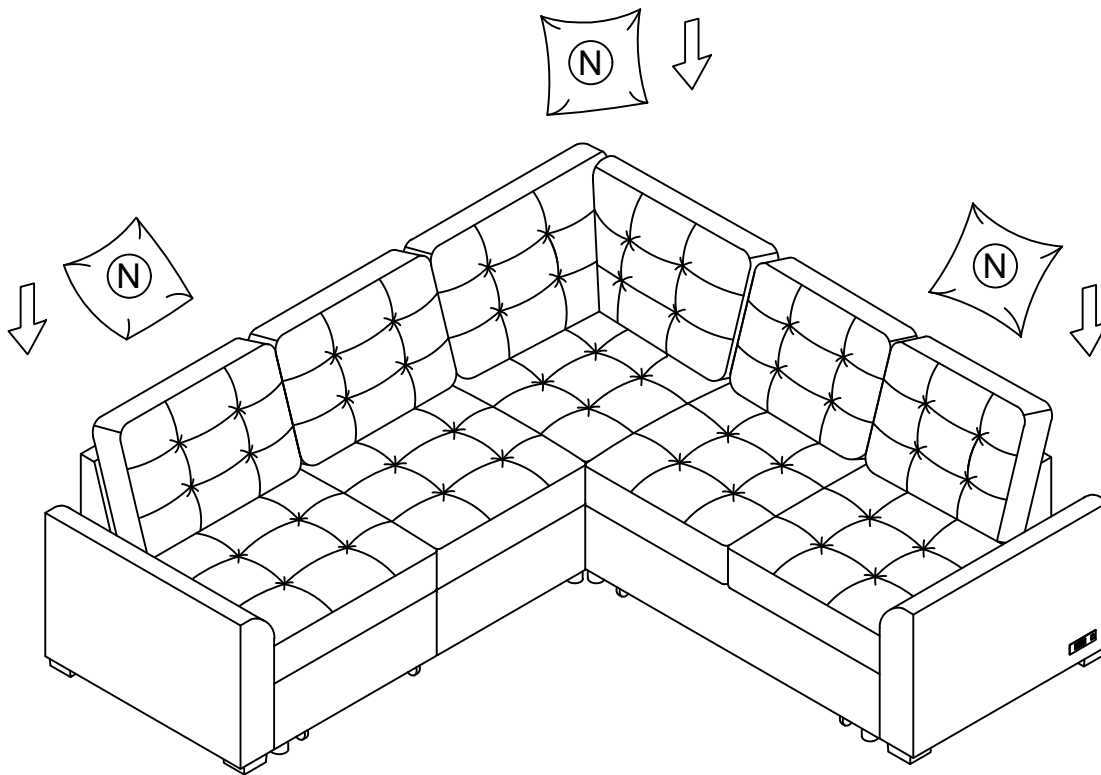

## Helpful Hints

- Sectional sofa can transform into a sleeper
- Move your new furniture carefully, with two people lifting and carrying the unit to its new location.
- Your furniture can be disassembled and reassembled to move.
- Clean the product with a soft damp cloth. DO NOT use harsh chemicals or abrasive cleaners.

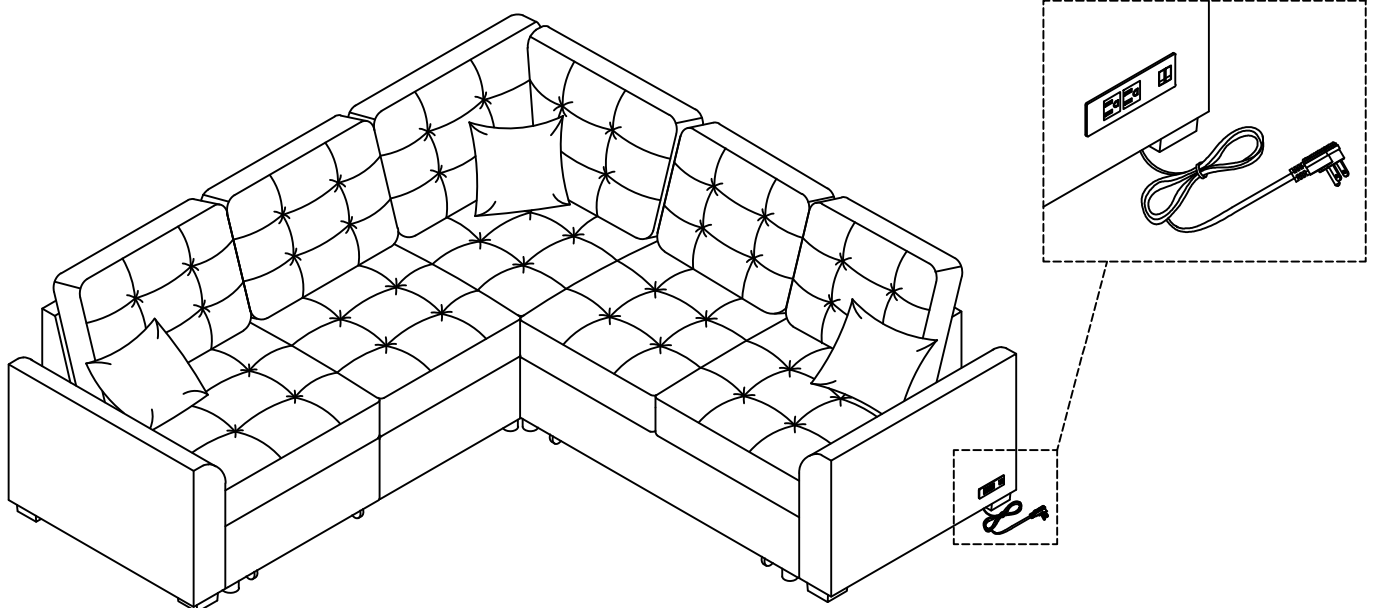

COMPLETE

