

ASSEMBLY INSTRUCTION / INSTRUCTIONS DE MONTAGE

N709P203153

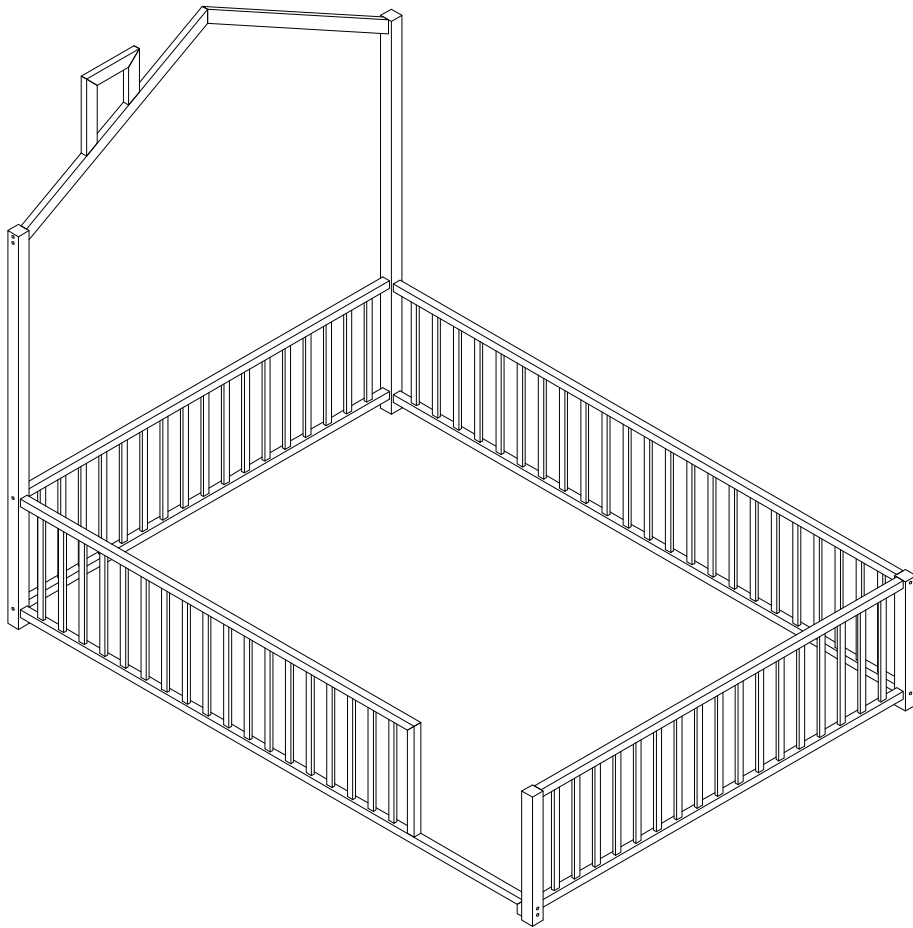

Minimum no. 2 of people
recommended to assemble
this product: Approx.

assembly time: 60 mins /

Nombre minimum 2 de personnes
recommandé d'assembler
ce produit : env.

temps de montage : 60 minutes

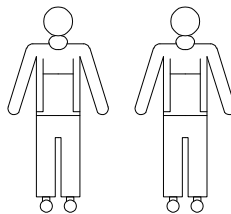

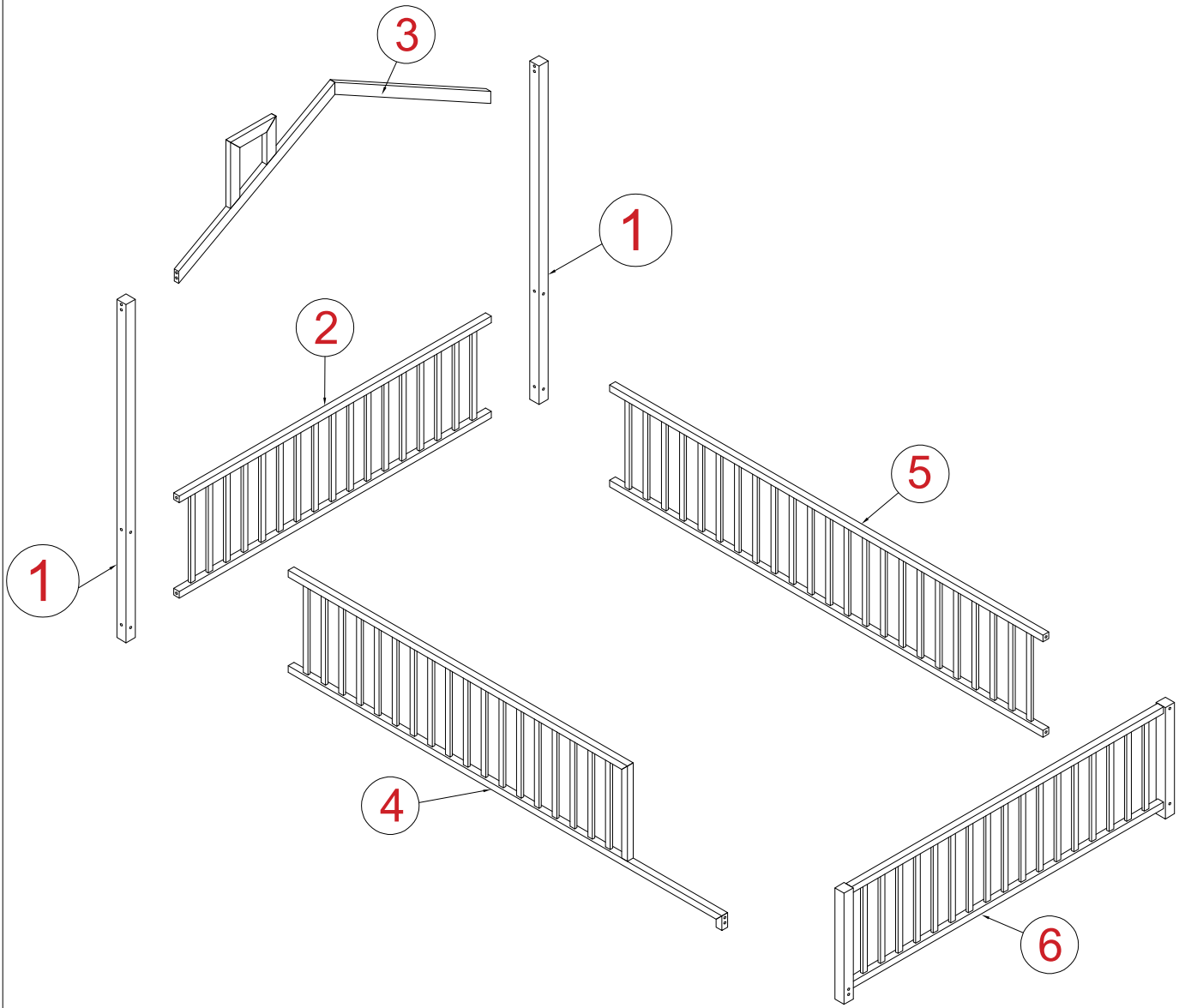



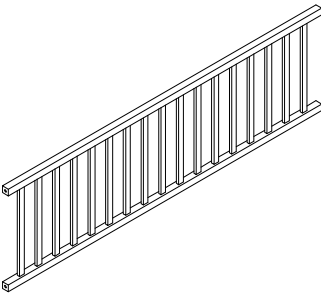
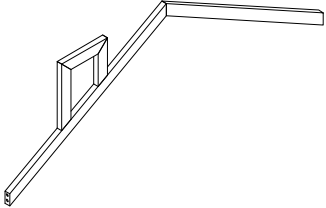
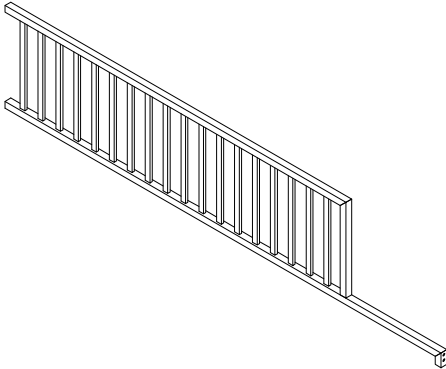
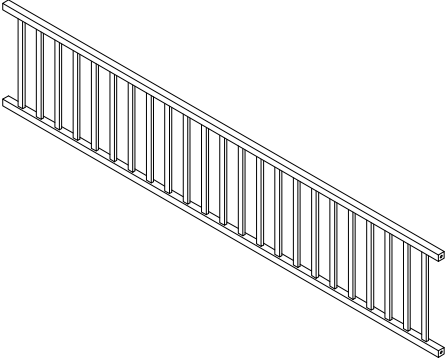
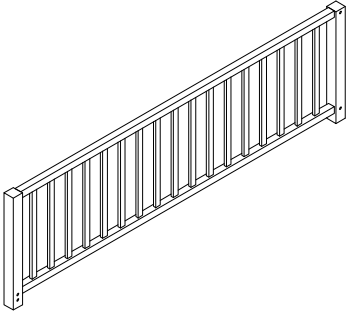

PART LIST N709P203153
/LISTE DES PIÈCES N709P203153

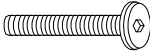
<p align="center">1</p>  <p>Leg 1 Étape 1</p> <p align="right">2PCS</p>	<p align="center">2</p>  <p>Horizontal shoulders 2/ Épaules horizontales 2</p> <p align="right">1PC</p>	<p align="center">3</p>  <p>Link bar 3/ Barre de liens 3</p> <p align="right">1PC</p>
<p align="center">4</p>  <p>Horizontal shoulders 4/ Épaules horizontales 4</p> <p align="right">1PC</p>	<p align="center">5</p>  <p>Bed shoulder 5/ Épaule de lit 5</p> <p align="right">1PC</p>	<p align="center">6</p>  <p>Horizontal shoulders 6/ Épaules horizontales 6</p> <p align="right">1PC</p>

HARDWARE LIST N709P203153
/LISTE DU MATÉRIEL N709P203153



<p align="center">A</p>  <p>M$\frac{1}{4}$"X55 16PCS</p>	<p align="center">B</p>  <p>#40x40x13 4PCS</p>	<p align="center">C</p>  <p>1PC M4X23X57</p>	
---	--	---	--

STEP 1/
ÉTAPE 1

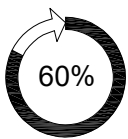
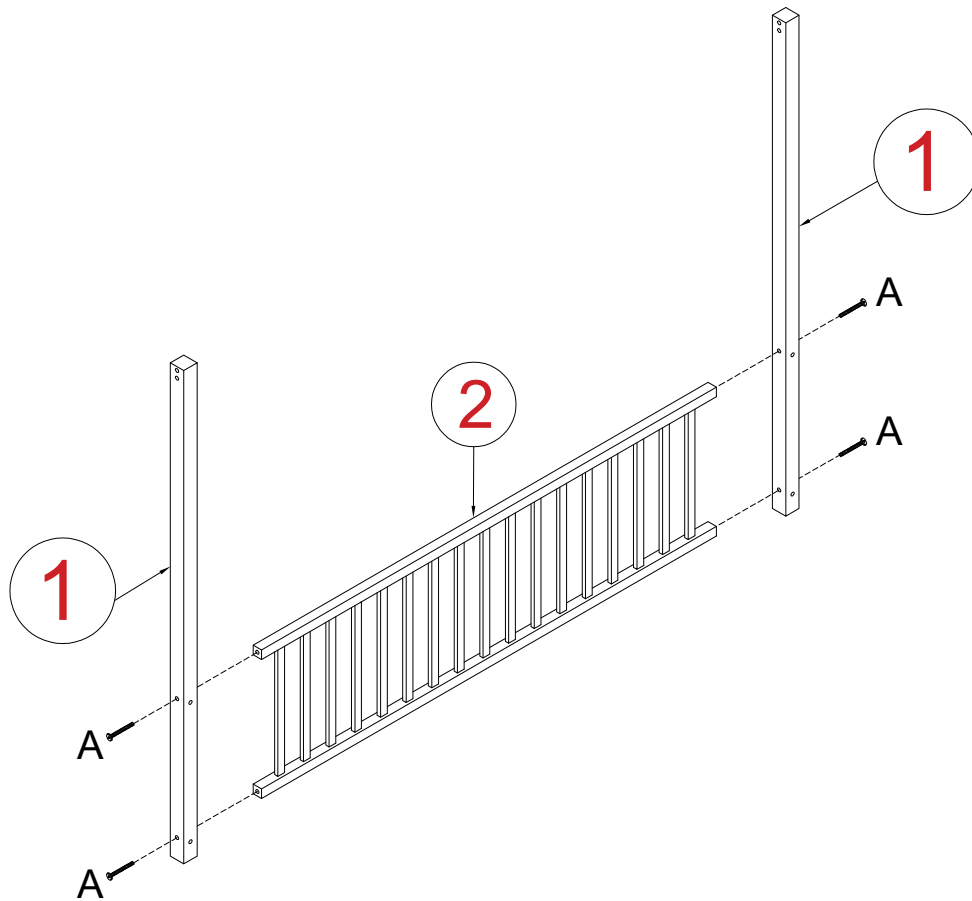
A

M $\frac{1}{4}$ "x55
4 PCS



STEP 2/
ÉTAPE 2

A	B
	
M $\frac{1}{4}$ "x55	#40x40x13
4 PCS	2 PCS

X-X

