

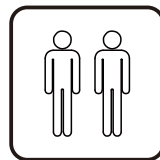

IN230800168V01_GL

845-921V00

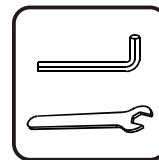
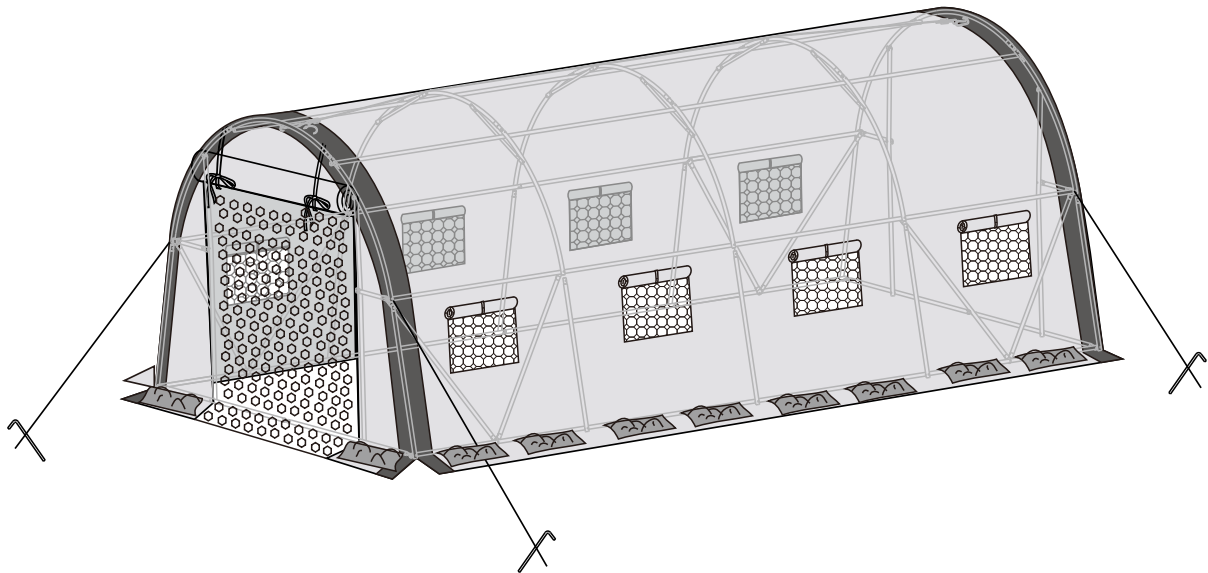

Tools Recommended

EN_IMPORTANT, RETAIN FOR FUTURE REFERENCE: READ CAREFULLY.

FR_IMPORTANT: A LIRE ATTENTIVEMENT ET À CONSERVER POUR CONSULTATION ULTÉRIEURE.

ES_IMPORTANTE, LEA Y GUARDE PARA FUTURAS REFERENCIAS.

PT_IMPORTANTE, RETER PARA REFERÊNCIA FUTURA: LEIA ATENTAMENTE.

DE_WICHTIG! SORGFÄLTIG LESEN UND FÜR SPÄTER NACHSCHLAGEN AUFBEWAHREN.

IT_IMPORTANTE! CONSERVARE IL PRESENTE MANUALE PER FUTURO RIFERIMENTO E LEGGERLO ATTENTAMENTE.

EN

Dear customer,

Thank you for purchasing this product. So that your appliance serves you well, please read all the instructions in this user's manual. If you have any questions, please contact our customer care center, Our contact details are below:

FR

Cher client,

Nous vous remercions d'avoir acheté ce produit. Afin que vous puissiez profiter pleinement de votre appareil, veuillez lire toutes les instructions de ce manuel d'utilisation. Si vous avez la moindre question, veuillez contacter notre centre d'assistance à la clientèle, Nos coordonnées sont les suivantes:

DE

Sehr geehrter Kunde,

Vielen Dank, dass Sie dieses Produkt erworben haben. Damit Ihr Gerät Ihnen gute Dienste leistet, lesen Sie bitte alle Hinweise in diesem Benutzerhandbuch. Wenn Sie Fragen haben, wenden Sie sich bitte an unser Kundendienstzentrum, Unsere Kontaktdaten stehen unten:

ES

Queridos clientes,

Gracias por comprar este producto. Para que su electrodoméstico le sirva mejor, lea todas las instrucciones de este manual del usuario. Si tiene alguna pregunta, comuníquese con nuestro Centro de Atención al Cliente, Nuestros datos de contacto son los siguientes:

PT



Caros clientes,

Obrigado por adquirir este produto. Para que o seu aparelho o sirva melhor, leia todas as instruções deste manual do utilizador. Se tiver alguma dúvida, por favor contacte o nosso Centro de Atendimento ao Cliente, Os nossos dados de contacto são os seguintes:

IT

Caro Cliente,

Grazie per aver acquistato questo prodotto. Per servirti meglio con questo apparecchio ti prego di leggere tutte le istruzioni in presente manuale utente. In caso di dubbio, si prega di contattare il nostro centro assistenza clienti, I nostri dettagli di contatto sono di seguito:

Country	 Phone	 Email
US	001-877-644-9366	customerservice@aosom.com
CA	416-792-6088	customerservice@aosom.ca
UK	0044-800-240-4004	enquiries@mhstar.co.uk
DE	0049-0(40)-88307530	service@aosom.de
FR	0033-1-84166106	aosom@mhfrance.fr
ES	0034-931294512	atencioncliente@aosom.es
PT	0034-931294512	info@aosom.pt
IT	0039-0249471447	clienti@aosom.it

① x 3

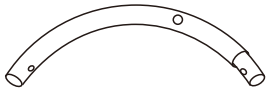

② x 3

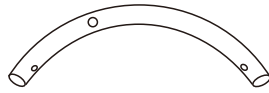

③ x 10



④ x 4

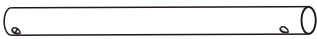

⑤ x 12

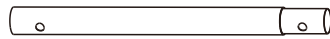

⑥ x 4

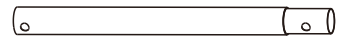

⑦ x 2

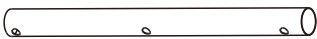

⑧ x 6

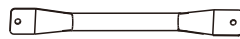

⑩ x 2

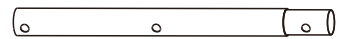

⑪ x 3



⑫ x 2



⑬ x 2

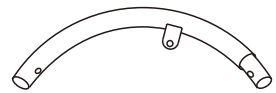

⑭ x 2

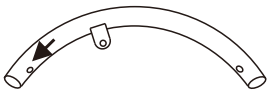

⑮ x 2

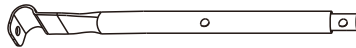

⑯ x 2

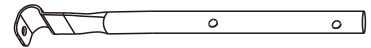

⑰ x 8

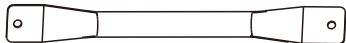

⑱ x 4



⑲ x 4

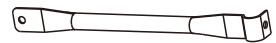

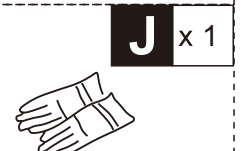
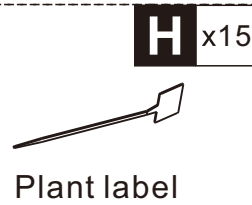
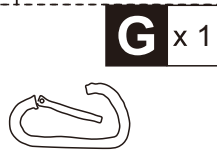
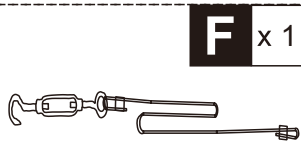
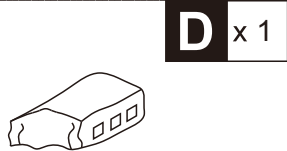
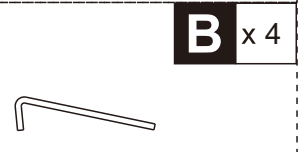
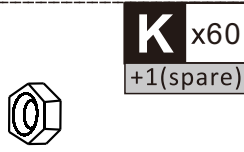
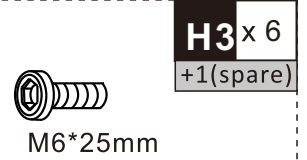
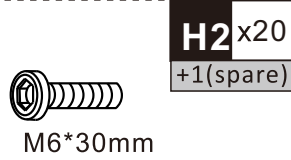
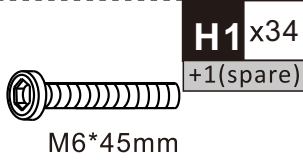

- 1 x1
- 2 x1
- 4 x2
- 5 x2
- 11 x1
- 12 x1
- 13 x1
- 14 x1
- A x2
- H₁ x4
- K x4

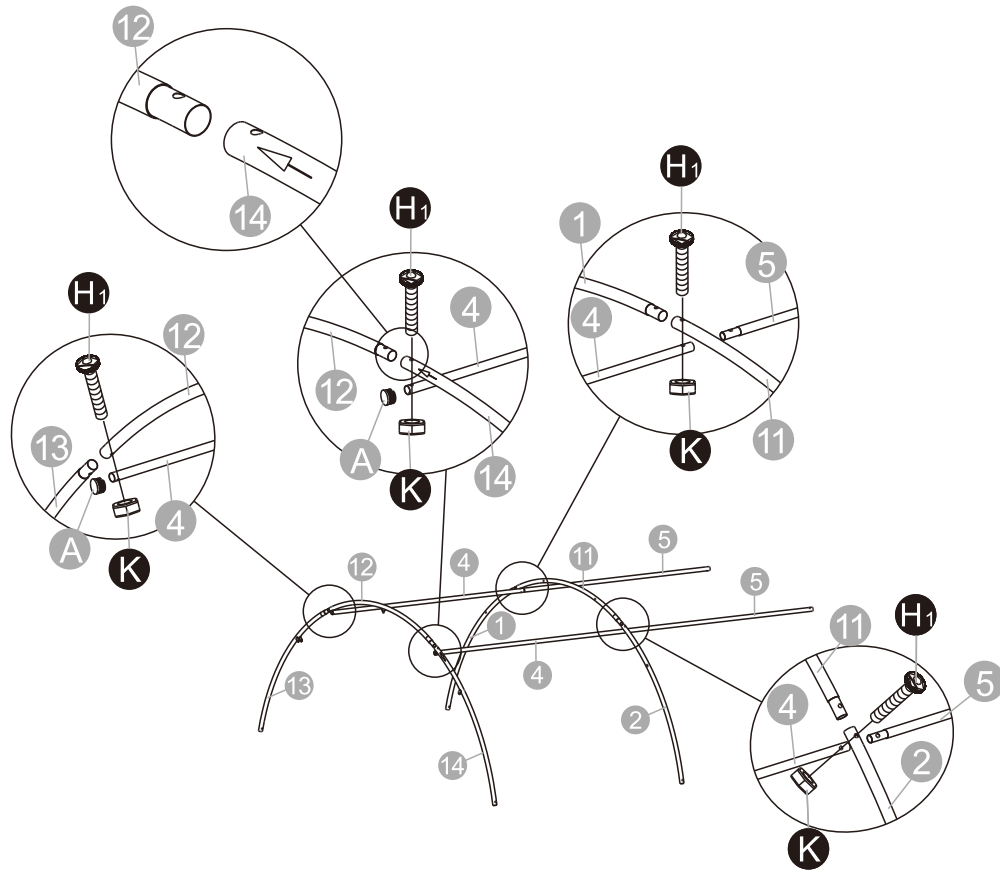

- 3 x4
- 4 x2
- 5 x4
- 7 x2
- 15 x1
- 16 x1
- 17 x4
- 19 x2
- A x2
- H₁ x8
- H₂ x2
- H₃ x1
- K x11

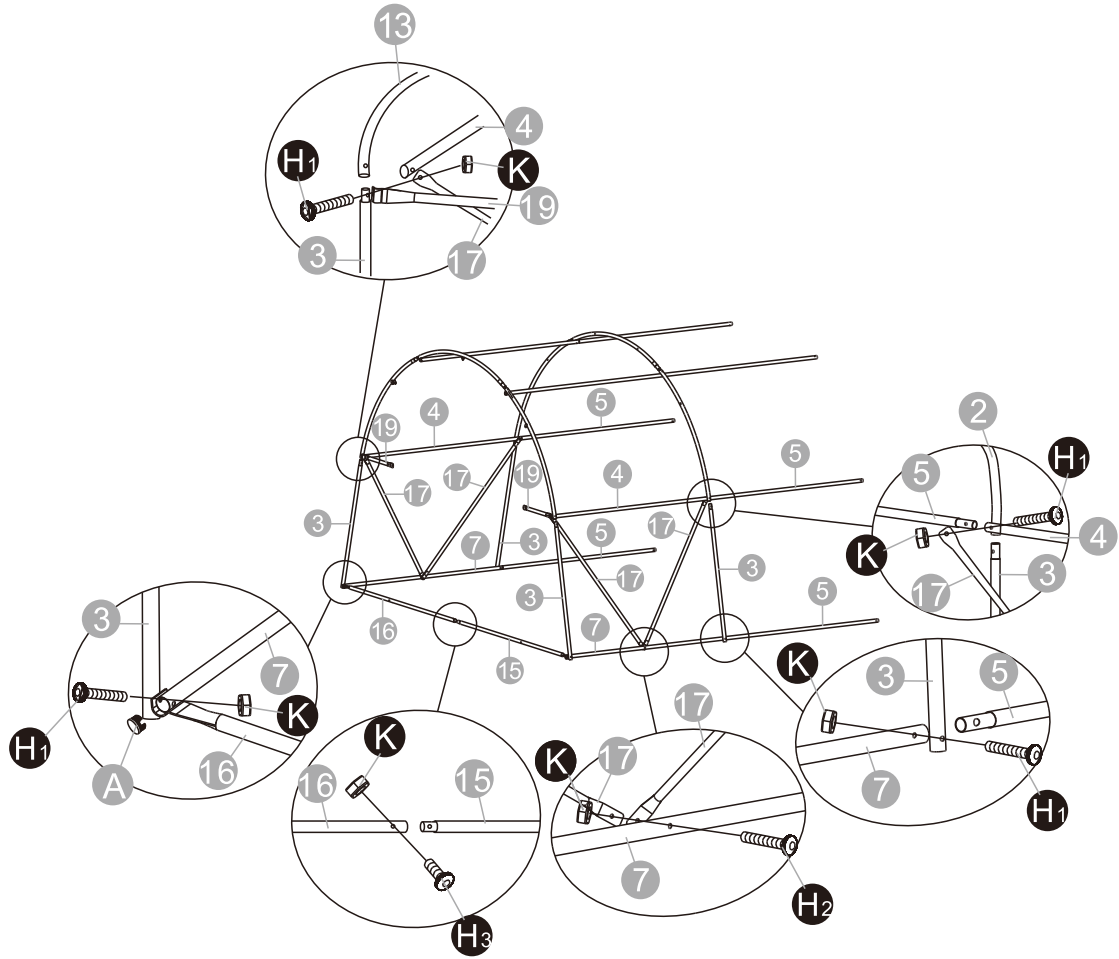

- 18 x2
- A x2
- H₁ x2
- H₂ x2
- H₃ x2
- K x6

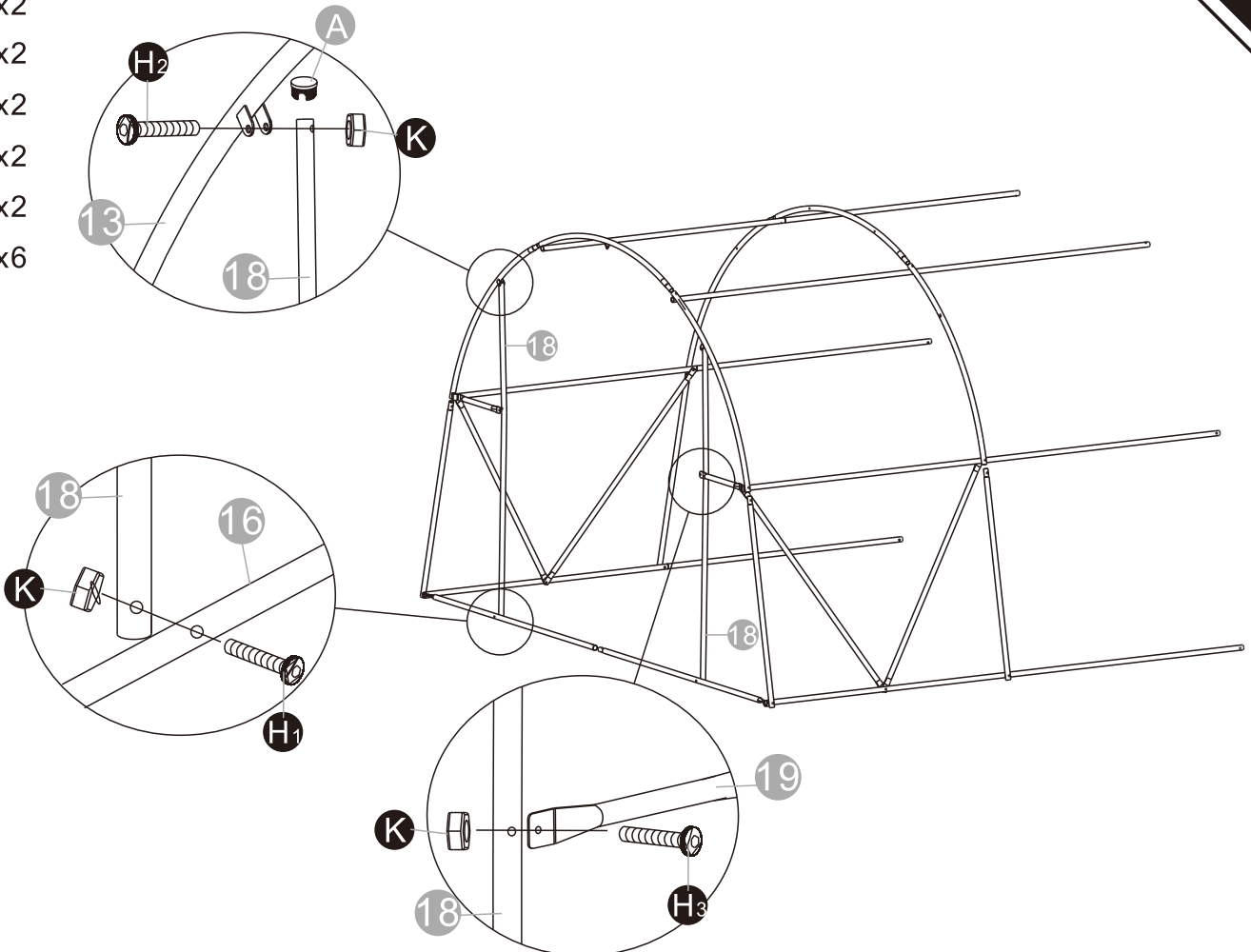

- 1 x1
- 2 x1
- 3 x2
- 5 x6
- 11 x1
- H₁ x6
- K x6

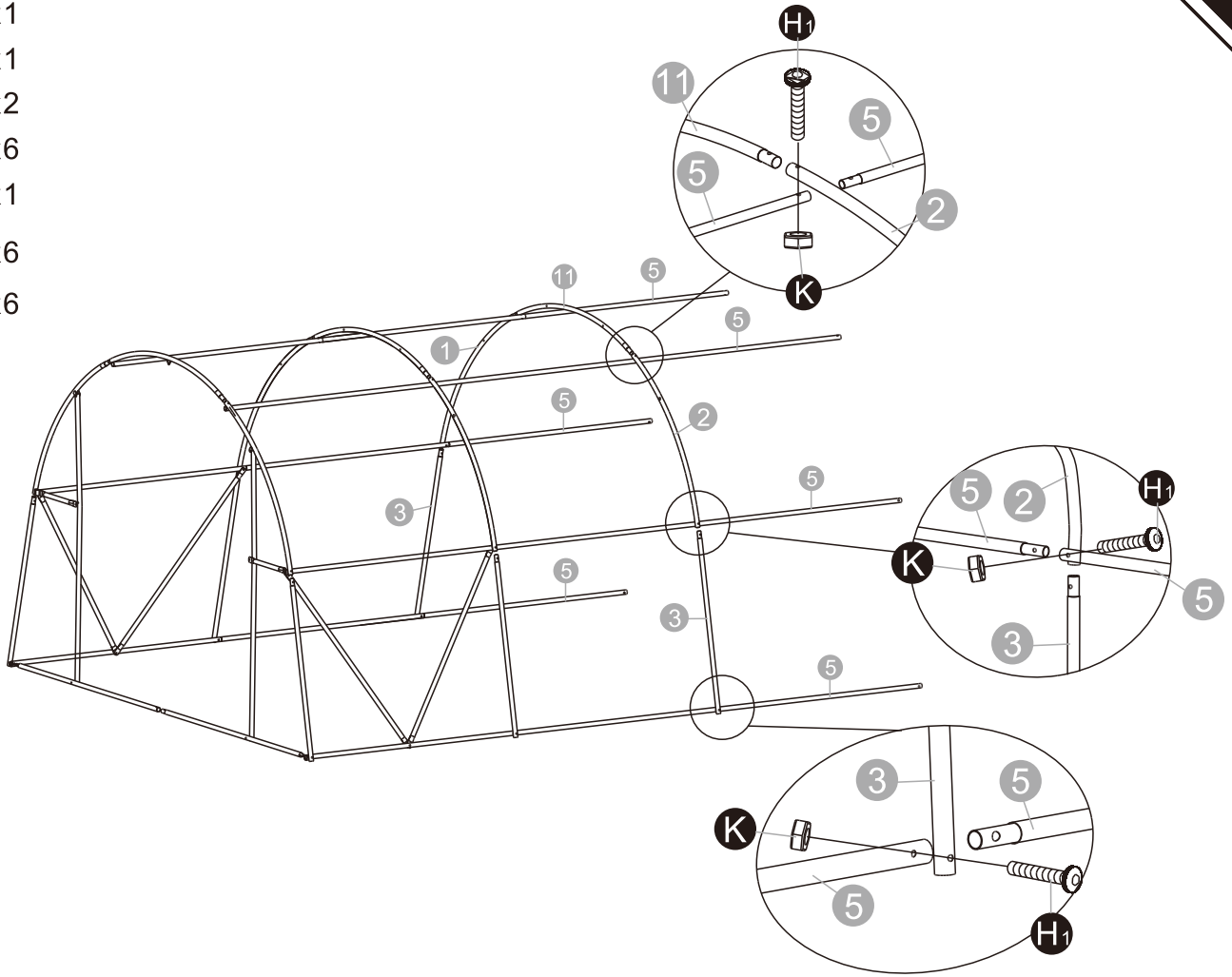

- 1 x1
- 2 x1
- 3 x2
- 6 x4
- 10 x2
- 11 x1
- 17 x4
- H₁ x6
- H₂ x2
- K x8

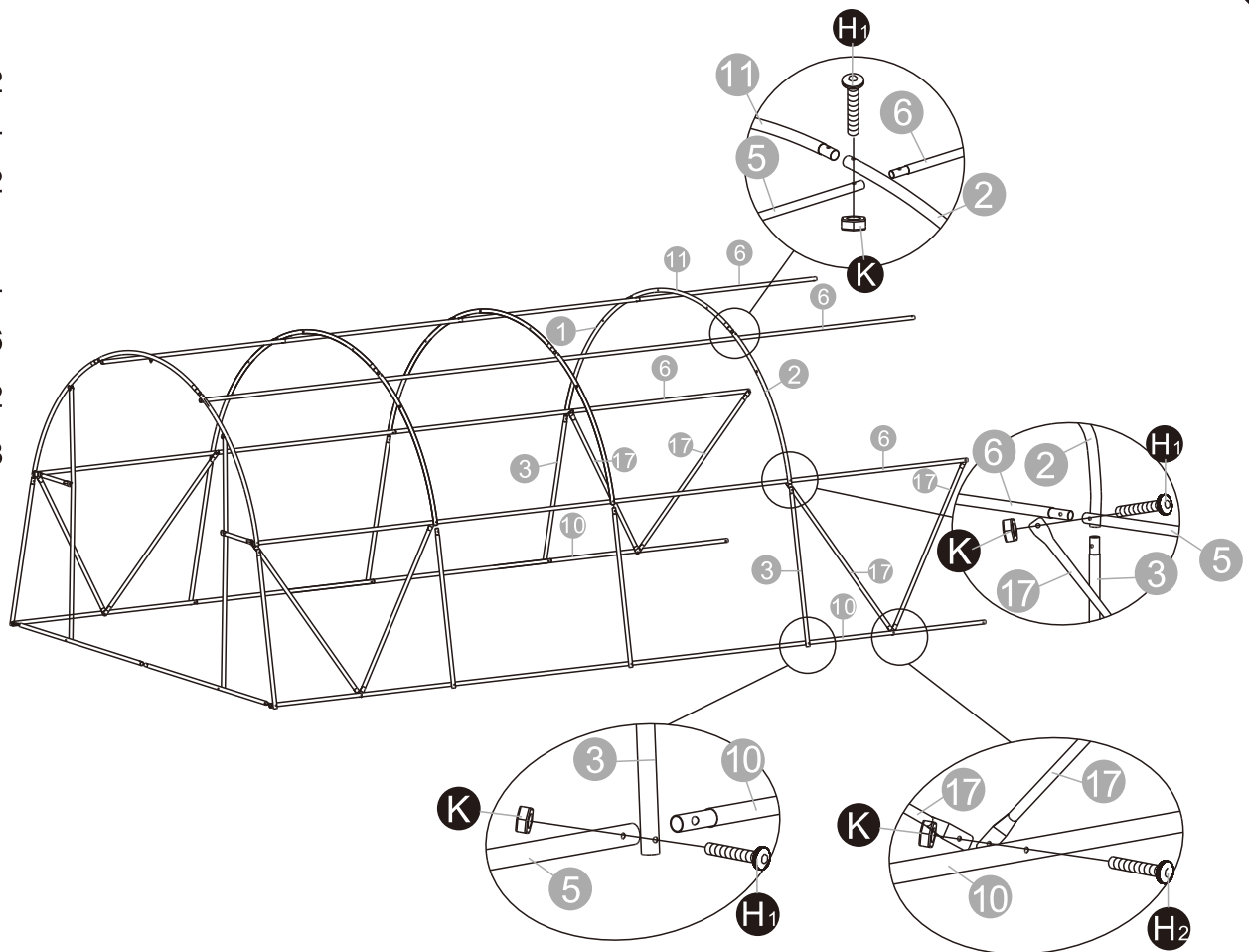

- 3 x2
- 12 x1
- 13 x1
- 14 x1
- 15 x1
- 16 x1
- 19 x2
- A x4
- H₁ x6
- H₃ x1
- K x7

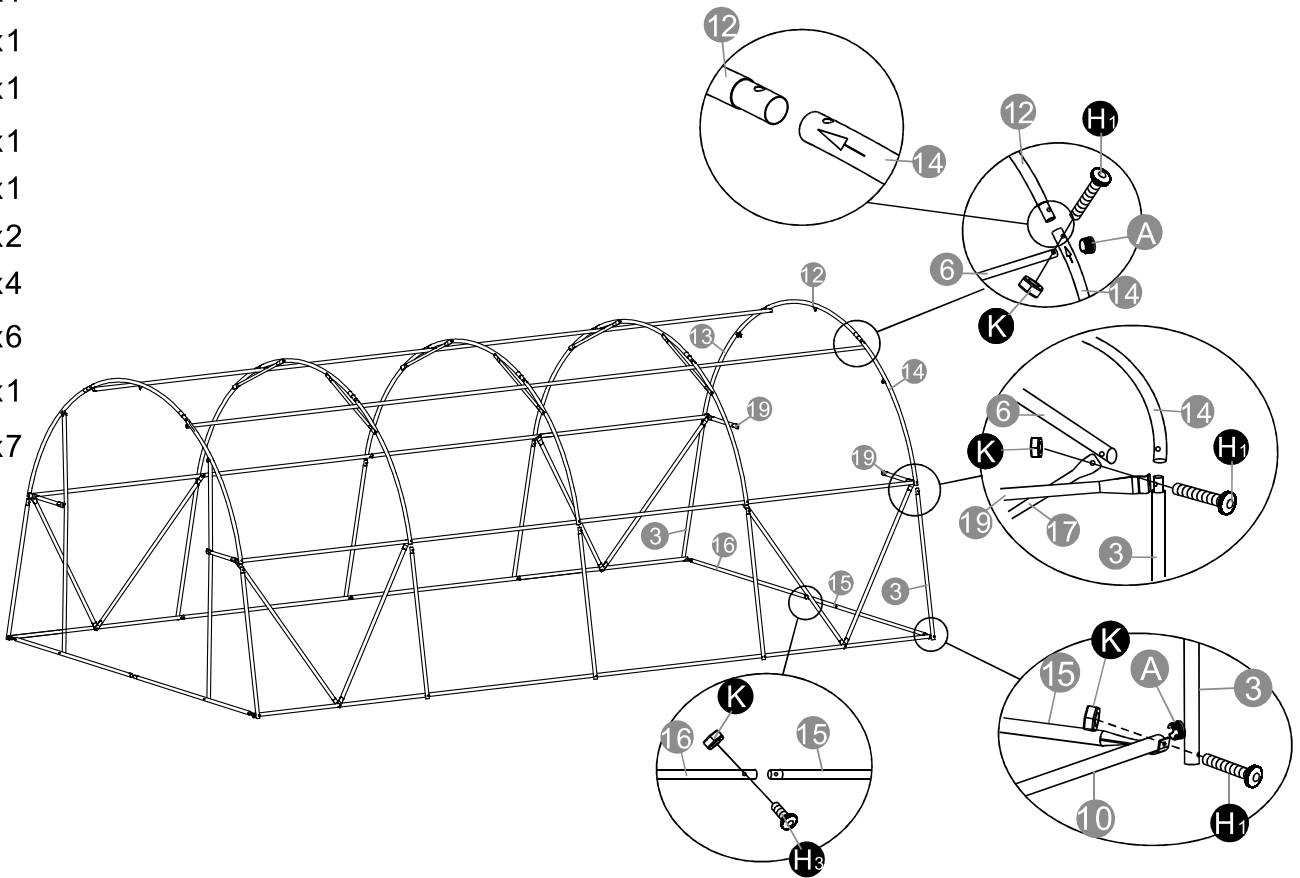

- 8 x6
- 18 x2
- A x2
- H₁ x2
- H₂ x14
- H₃ x2
- K x18

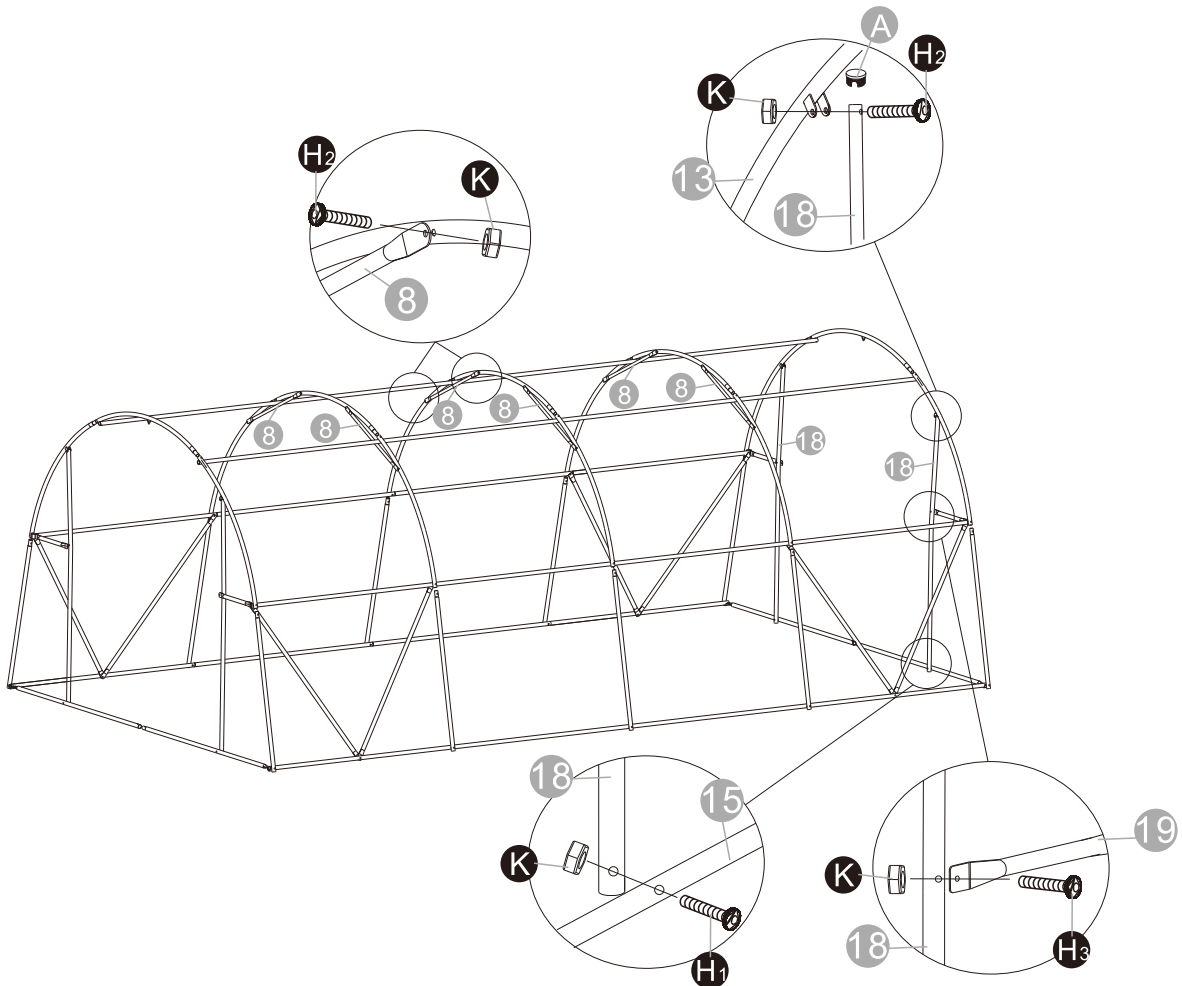

EN Press the soil on the edge of the soil around the greenhouse.

FR Tasser la terre sur le bord du sol autour de la serre.

ES Presione el suelo en el borde de tierra alrededor del invernadero.

PT Pressionar o solo na borda do solo em redor da estufa.

DE Drücken Sie die Erde am Rand des Bodens um das Gewächshaus herum an.

IT Premere il terreno sul bordo attorno alla serra.

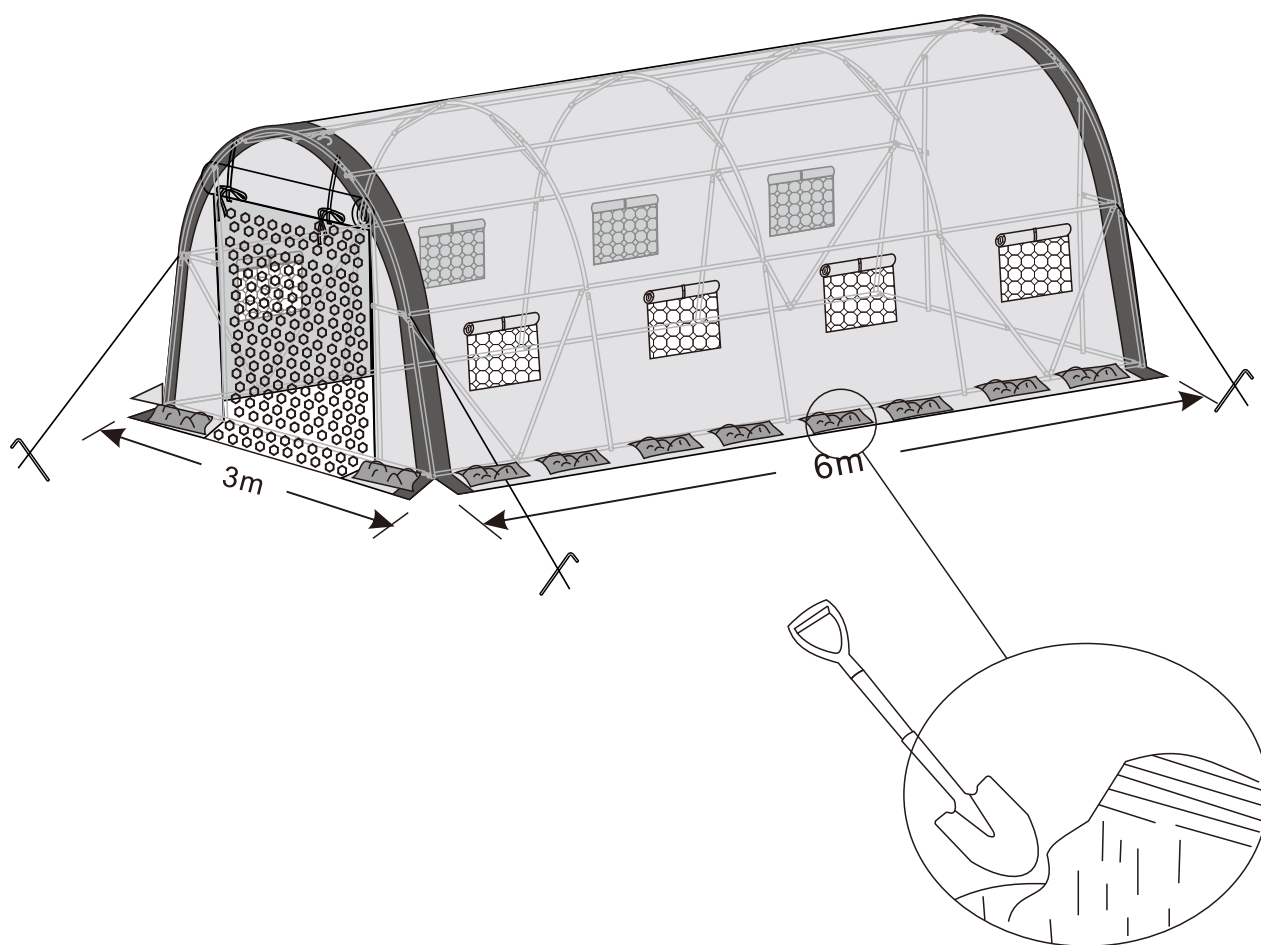

EN Be sure to always secure this greenhouse with rope attached to ground nail when in use

FR Assurez-vous toujours de sécuriser cette serre avec une corde attachée à un piquet de sol lorsque vous l'utilisez.

ES Asegúrese de atar las cuerdas a los clavos de tierra para fijar este invernadero cuando esté en uso.

PT Durante o uso, por favor, não se esqueça de prender a estufa amarrando a corda a uma estaca no chão.

DE Bitte befestigen Sie das Seil bei der Verwendung des Gewächshauses an den Heringen, um es zu fixieren.

IT Per garantire la sicurezza durante l'uso, fissare sempre la serra al terreno utilizzando una corda agganciata ad un picchetto infisso nel terreno.

US

Imported by Aosom LLC
 27150 SW Kinsman Rd Wilsonville, OR 97070 USA
 MADE IN CHINA

CA

Imported by Aosom Canada Inc.
 7270 Woodbine Avenue, Unit 307, Markham, Ontario Canada
 L3R 4B9
 MADE IN CHINA

Importé par Aosom Canada Inc.
 7270 Woodbine Avenue, unité 307, Markham, Ontario Canada
 L3R 4B9
 Fabriqué en Chine

UK

IMPORTER ADDRESS:
 MH STAR UK LTD
 Unit 27, Perivale Park,
 Horsenden lane South
 Perivale, UB6 7RH
 MADE IN CHINA

FR

ADRESSE D'IMPORTATION:
 MH FRANCE
 2 Rue Maurice Hartmann
 92130 Issy Les Moulineaux
 France
 FABRIQUÉ EN CHINE

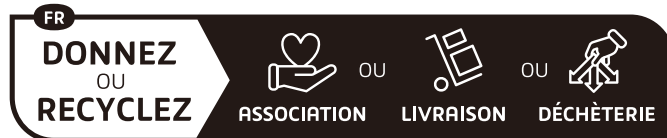

Adresses sur quefairedemesdechets.fr

ES

IMPORTADOR:
 SPANISH AOSOM, S.L.
 C/ROC GROS, Nº15.08550, ELS HOSTALET DE BALENYÀ, SPAIN.
 B66295775
 WWW.AOSOM.ES
 ATENCIONCLIENTE@AOSOM.ES
 TEL: 931294512
 HECHO EN CHINA

PT

SPANISH AOSOM, S.L
 C.ROC GROS N.15, 08550. ELS HOSTALET DE BALENYÀ
 TEL: 931294512 (SEG-SEX DAS 7:30H ÀS 16:30H)
 INFO@AOSOM.PT
 WWW.AOSOM.PT

DE

ADRESSE DES IMPORTEURE:
 MH Handel GmbH
 Wendenstraße 309
 D-20537 Hamburg
 Germany
 IN CHINA HERGESTELLT

IT

IMPORTATO DA:
 AOSOM Italy srl
 Centro Direzionale Milanofiori
 Strada 1 Palazzo F1
 20057 Assago (MI)
 P.I.: 08567220960
 FATTO IN CINA