

Assembly Instructions

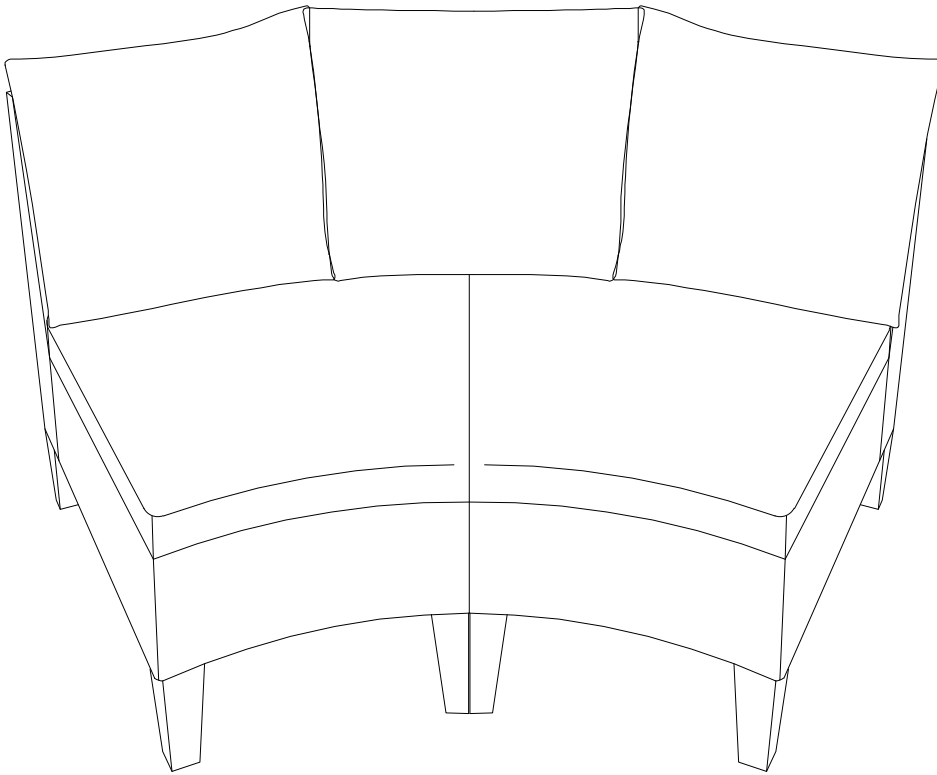

**Assembly
Video**







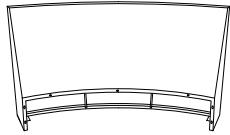
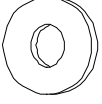
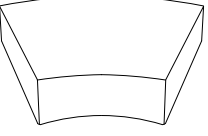
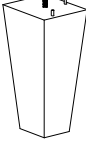

For any missing hardware, damaged parts and other problems.
WELCOME to email us at: service@behousewell.com

Or call at 1-888-733-8169 Toll free
Between 9AM and 5PM Eastern time, Monday through Friday

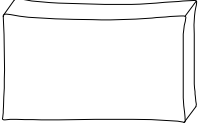
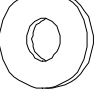
***Don't fully tighten all the bolts till the very end!**

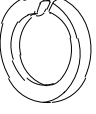
PRE-ASSEMBLY PREPARATION:

- Please read through the instructions before beginning assembly.
- Clear out the space for assembly and lay out all of the parts based on the Parts List, extra room will allow you to easily determine if all the pieces are present.
- Keep small parts and pieces away from children until fully assembled.

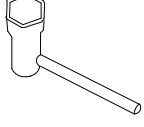
Part no.	Part	QTY	Image	Part no.	Part	QTY	Image
A	Back	2		H	Washer Ø16*Ø6.5*1mm	14	
B	Seat	2		I	Leg	8	
C	Seat cushion	2		J	Nut M8	8	
D	Long back cushion	2		K	Washer Ø18*Ø8.5*1mm	8	
E	Short back cushion	1		L	Spring washer Ø8.5mm	8	
F	Bolt (M6*30mm)	8		M	Allen Wrench	1	
G	Bolt (M6*40mm)	6		N	Wrench	1	

Step 1: Attach 1pc seat B to 1pc back A with 4pcs bolts F, 3pcs bolt G and 7pcs washers H, using Allen wrench M.

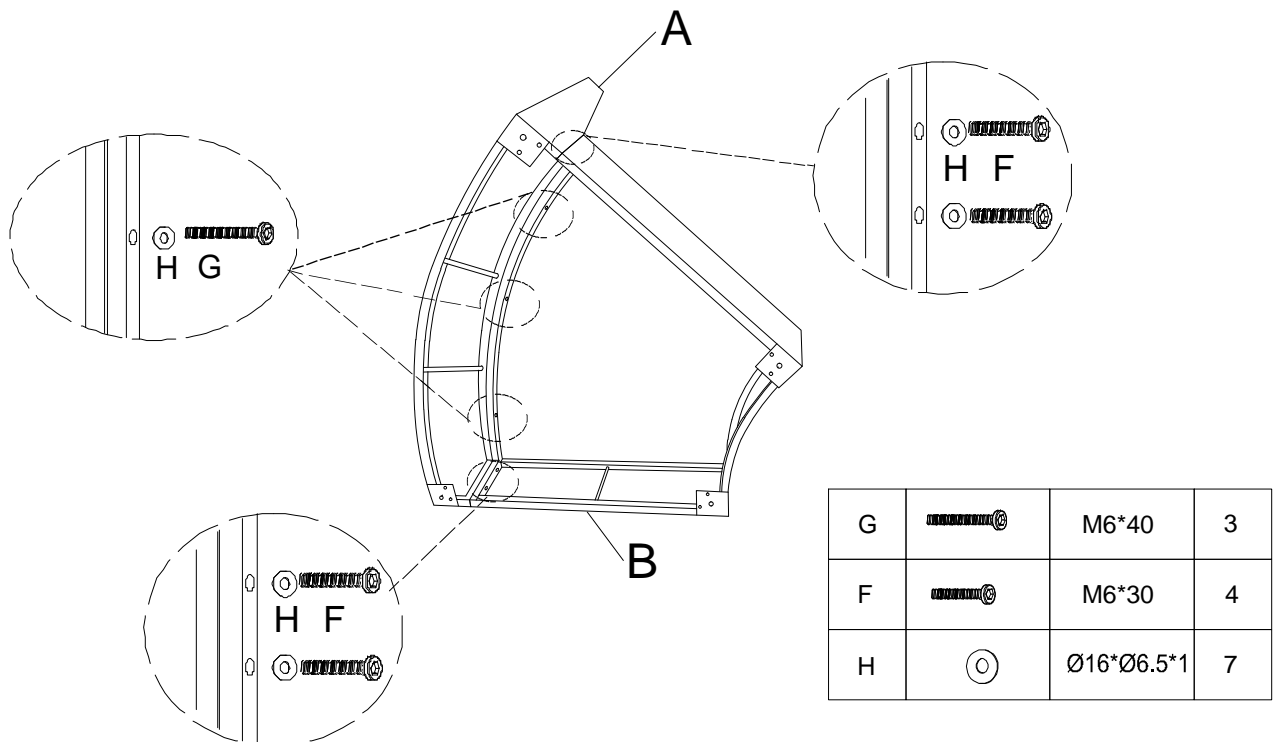

Step 2: Attach 4pcs legs I to back A and seat B with 4pcs washers K, 4pcs spring washers L and 4pcs nuts J, using wrench N. Repeat step 1 and 2 to get another one chair.

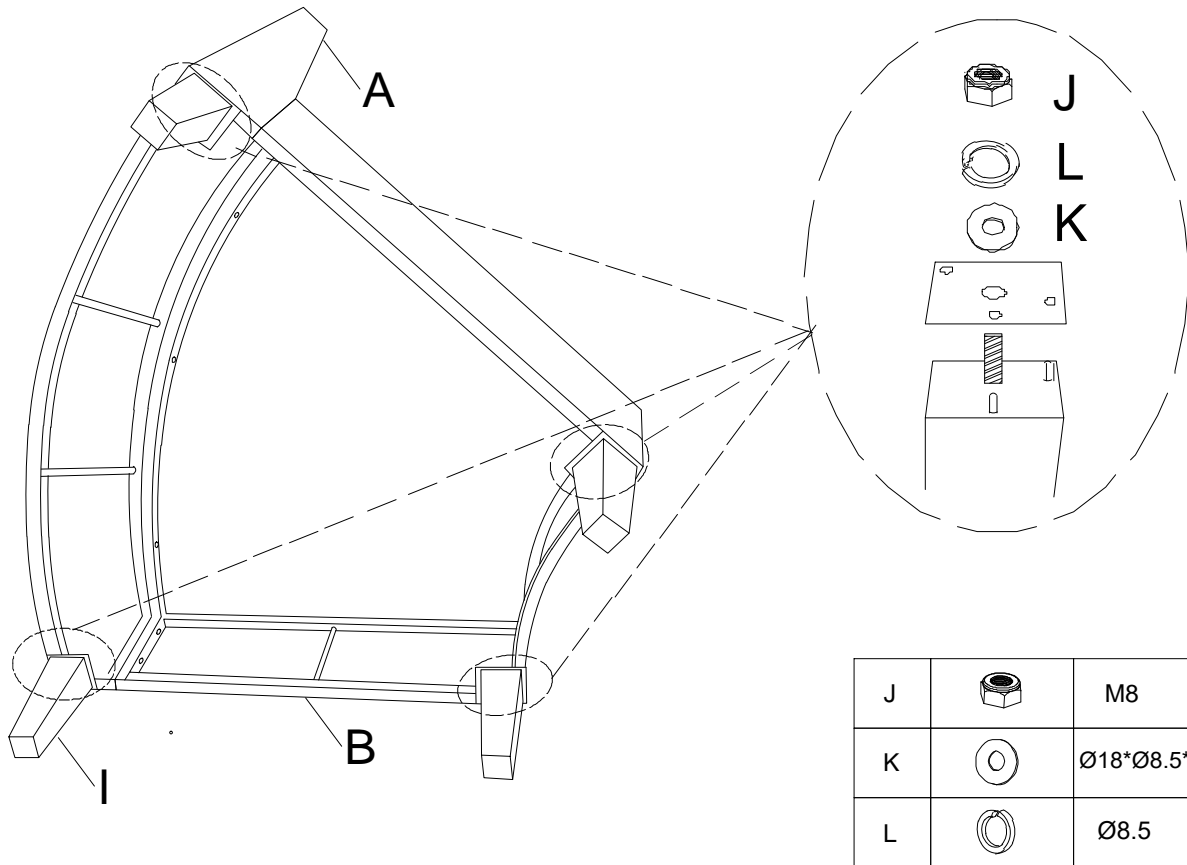

Step 3: Put seat cushions C and back cushions D & E onto the seat of 2 chairs. Assembly is now complete and the product is ready for use.

