

Safety Instructions

Please read this notice carefully and keep it all along the use of this product. Follow the instructions for a safe and correct installation and functioning of the fitting.

The manufacturer does not accept any responsibility for damage caused by improper installation and service.

Always isolate the power before commencing installation, maintenance or repair. In case of doubts, please contact a qualified electrician.

This product is for indoor use only. Please do not use it on humid places. Do not put it in contact with water or any liquids or inflammable products. Always respect the minimal distance (indicated on the light) to inflammable products.

During installation, make sure that the cables will not be squeezed or damaged by sharp edges. If the external flexible cable is damaged, it needs to be replaced exclusively by the manufacturer, his service agent, or another qualified electrician. This is to avoid all risks.

This Light is with Glass Shades, it's fragile, please be careful while cleaning and installing.

DC12V LED G4 Bulbs Required, Max 3W

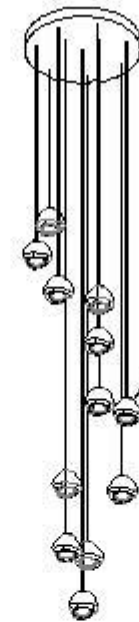

How to hang the balls

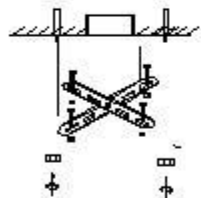
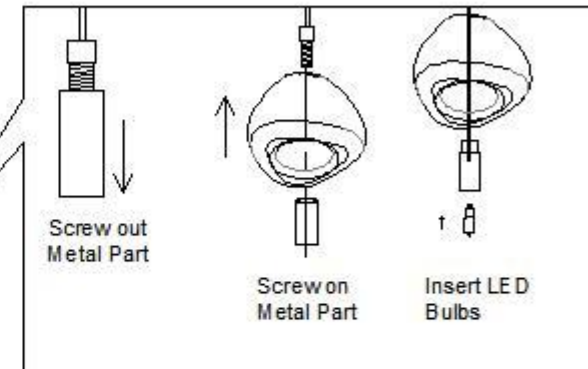

Install Metal Bracket to Ceiling

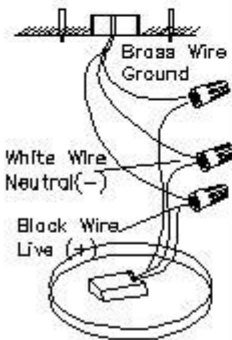

Connect the wires

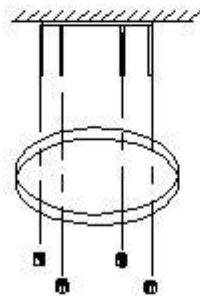

install the canopy to ceiling

How to lower and extend the wires

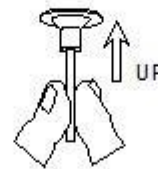

1. simply push up on the cable to raise the height of the fixture

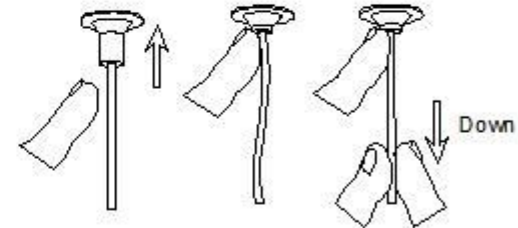

1. Using the tip of your finger or fingernail, depress the pin into the ceiling canopy, this will release the cable locking mechanism

2. While holding the pin in place, simply push down on the cable to lower the height of the fixture