

ASSEMBLY INSTRUCTION FOR ACME FURNITURE







MODEL #DN01370 ARM CHAIR (SET-2)

Thank you for purchasing this quality product. Be sure to check all packing material carefully for small parts which may have come loose inside the carton during shipment. Separate, identify and count all parts and metal hardware. Compare with parts list to be sure all parts are present. If any part are missing or damaged, please contact your local furniture dealer. For efficient and speedy service, please indicate the model number and code letter of part needed.

*** Do not fully tighten screws until fully assembled ***

Component Parts		
Descr ip Tion	Part Name	Q'TY(Pcs)
①	Leg	2
②	Frame	1
③	Back	1
④	Left Armrest	1
⑤	Right Armrest	1

Hardwares Required

(A)		Bolt	5/16"*3-1/4"	4	Pcs
(B)		Bolt	5/16"*2-1/4"	4	Pcs
(C)		Bolt	5/16"*1-3/4"	3	Pcs
(D)		Spring Washer	5/16"	11	Pcs
(E)		Flat Washer	5/16"*22mm	11	Pcs
(F)		Allen Wrench	5mm	1	Pcs
(G)		Screw	8mm*1-1/2"	2	Pcs

Step 1

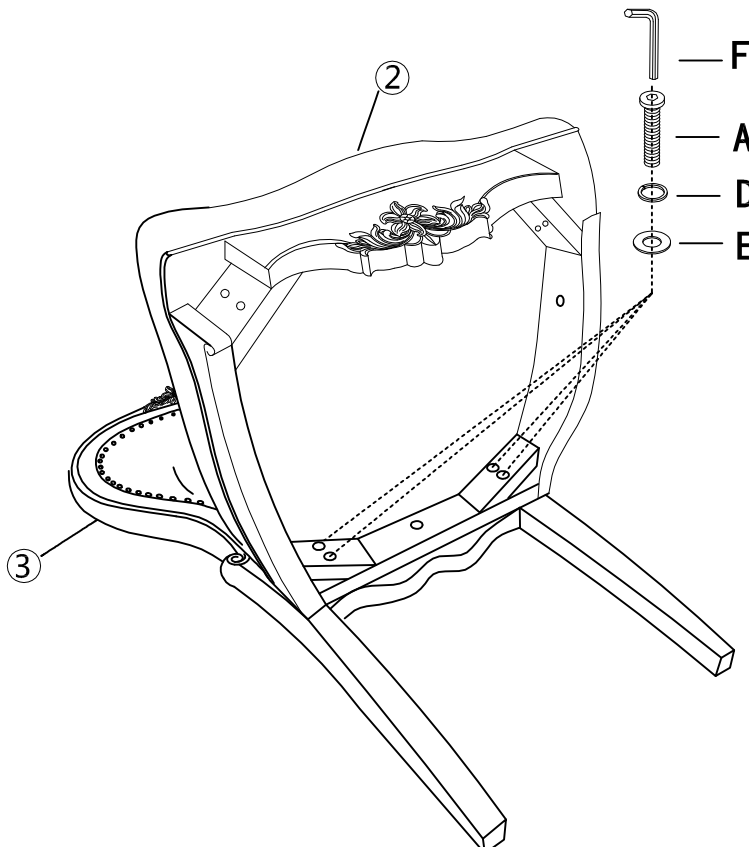

Step 2

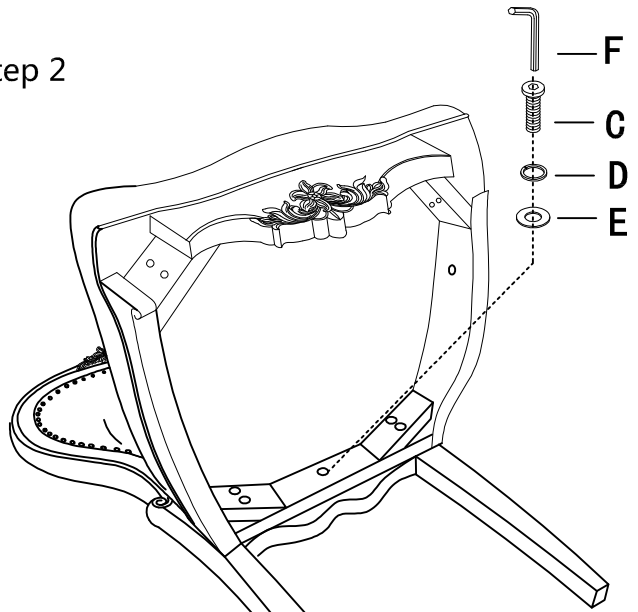

Step 3

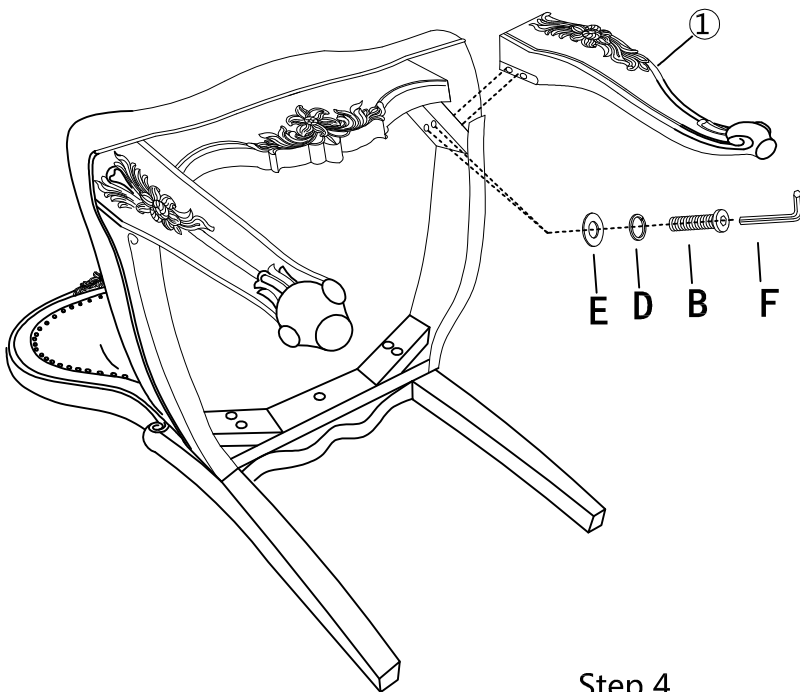

Step 4

