

# Assembly Instruction

SKU:WF310556/WF310557/WF310558

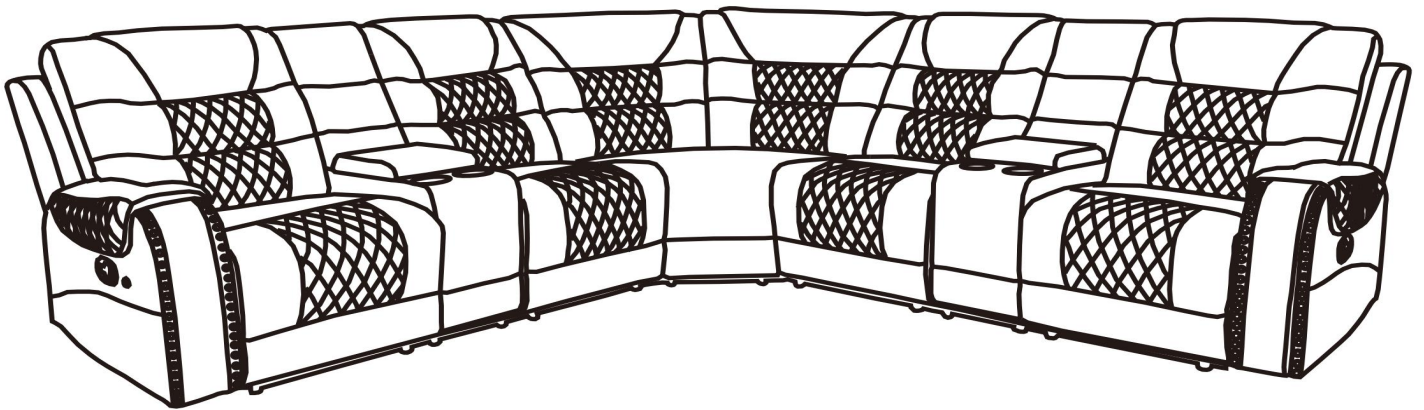

# PARTS

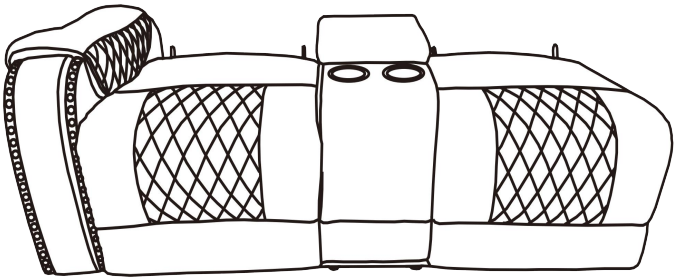

A

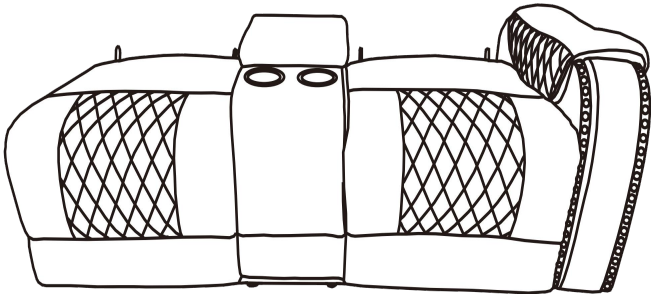

B

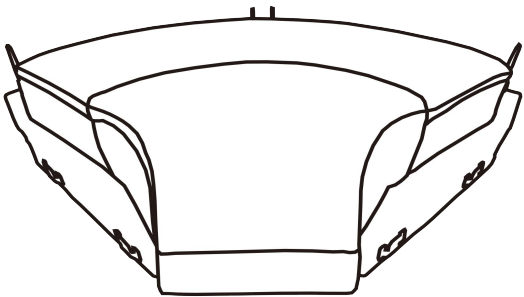

C

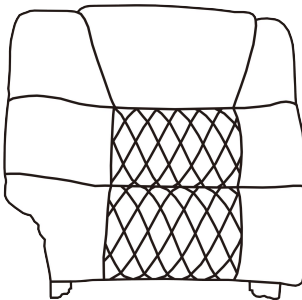

D

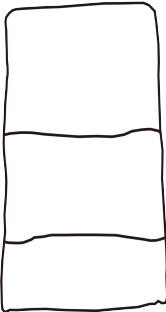

EX2

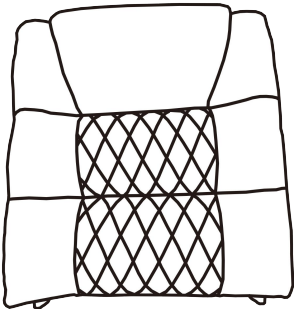

FX2

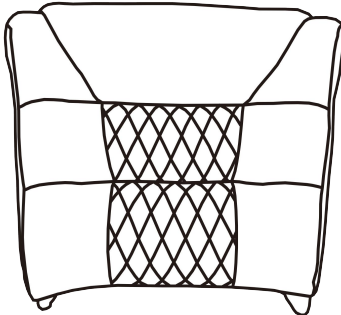

GX2

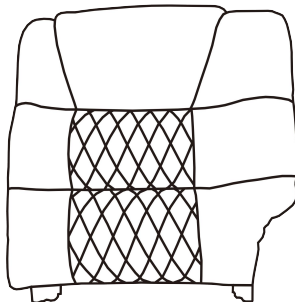

H

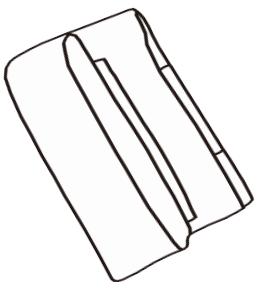

I

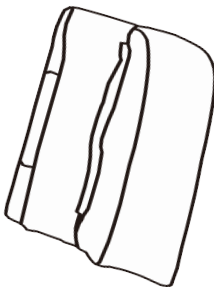

J

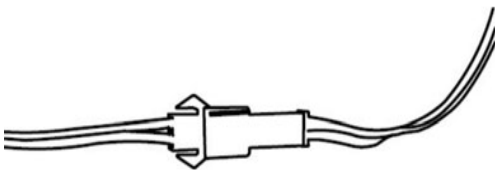

K

PARTS LIST - BOX 1  
SKU:WF310556

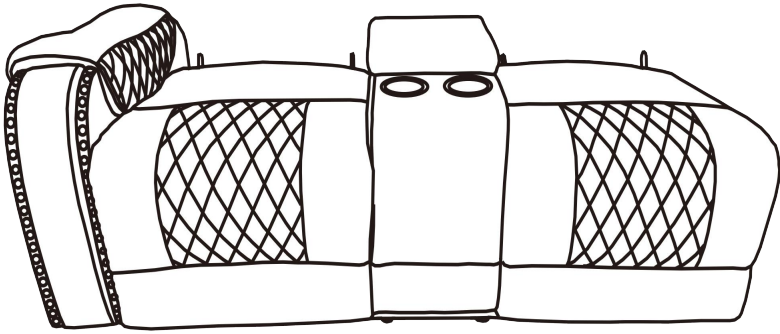

A



D

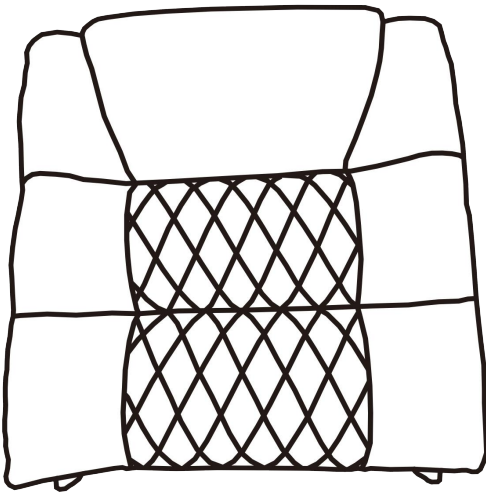

F

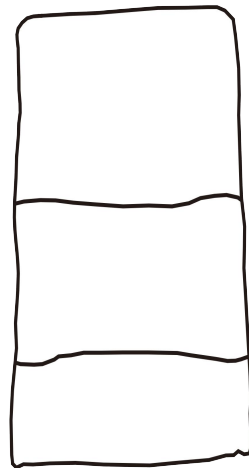

E

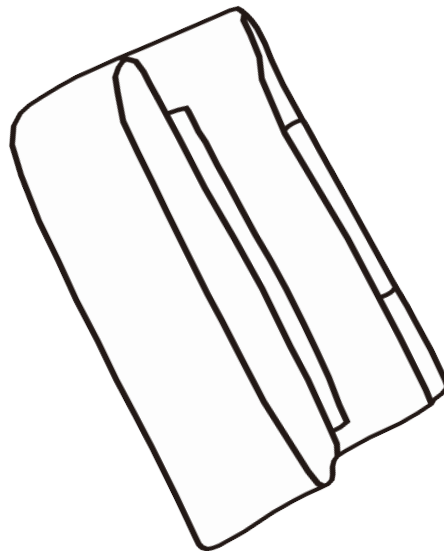

I

PARTS LIST - BOX 2  
SKU:WF310558

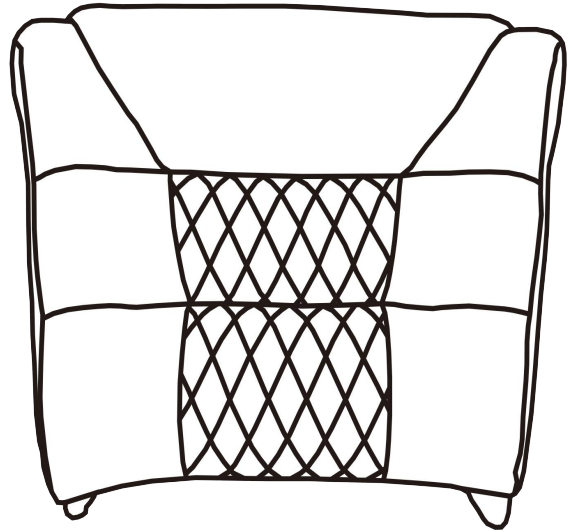
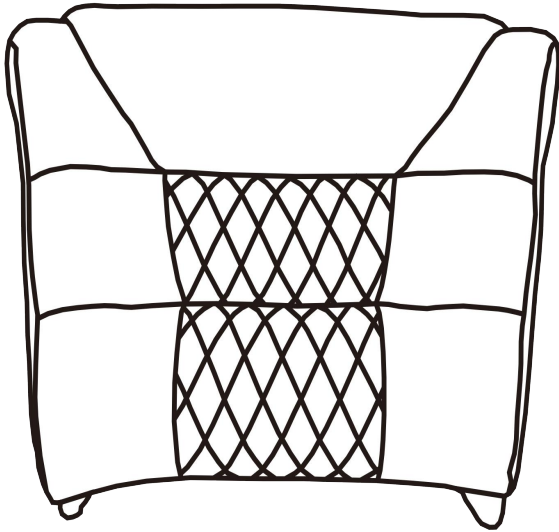

GX2

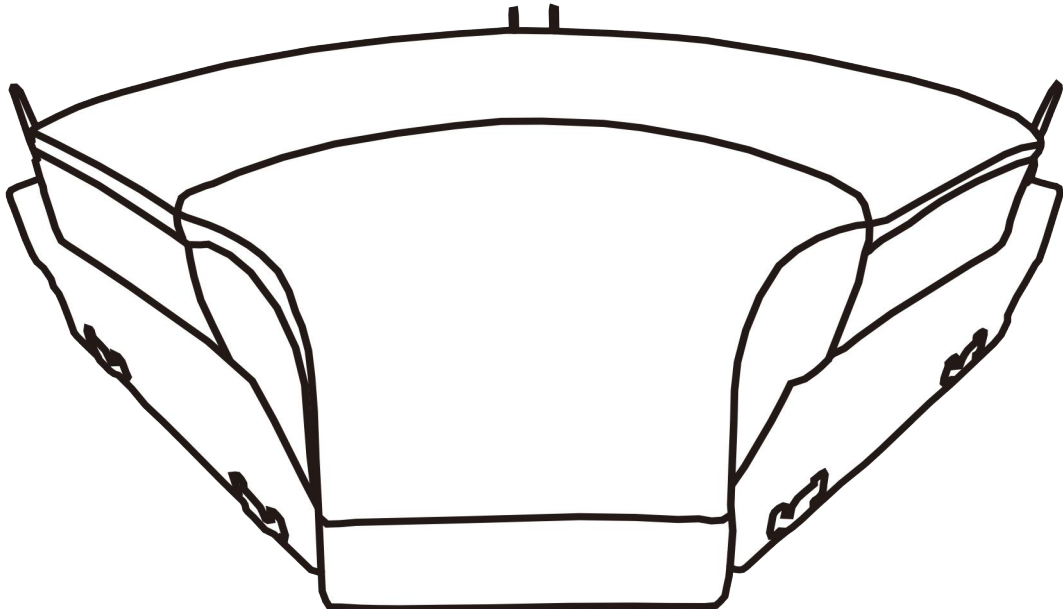

C

PARTS LIST - BOX 3  
SKU:WF310557

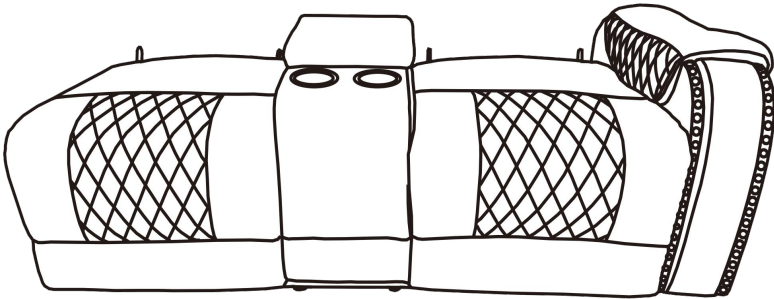

B

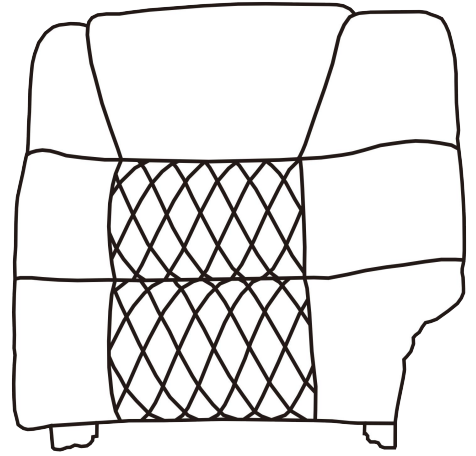

H

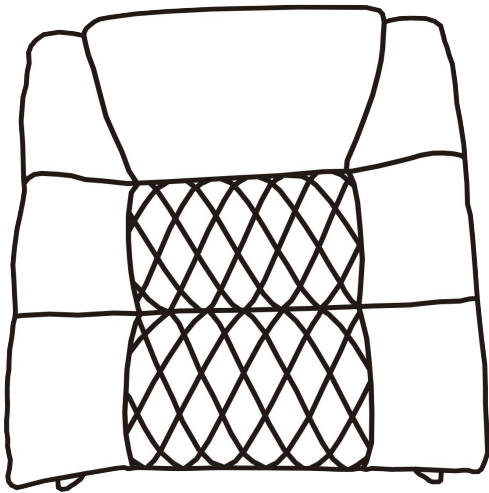

F

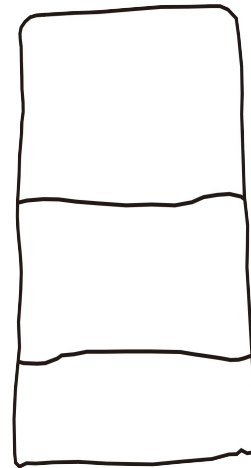

E



J

Step1:

Take the Console Backrest (D) out of the Console Base part of the Seat (A&B)

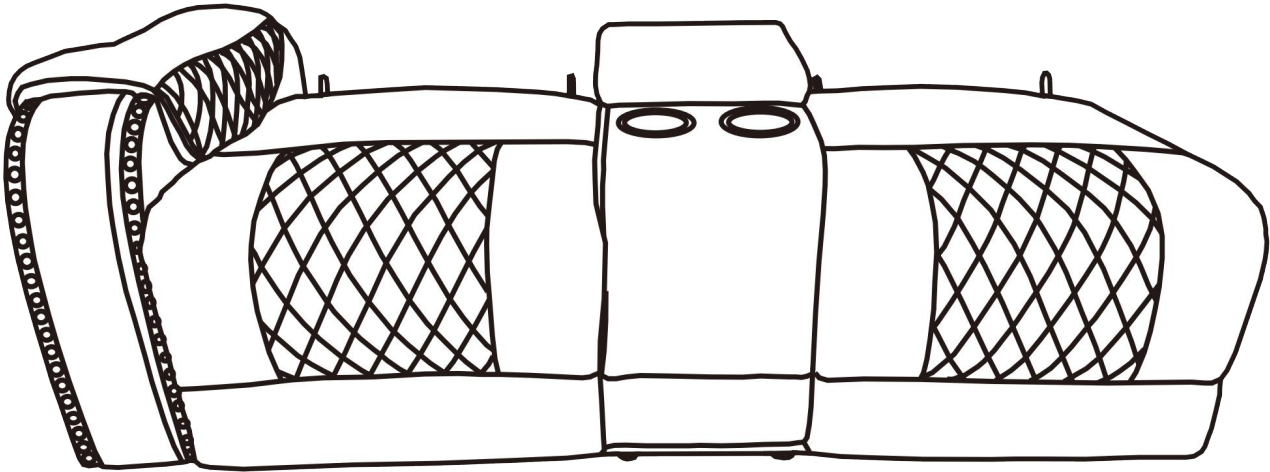

A



E

Console backrest

Step2:

Install the LSF backrest (D), Console back (E), and RSF backrest (F) by align and insert the metal bracket to the metal brackets of the seat (A). Please make sure the brackets and console back are inserted all the way and secured into position.

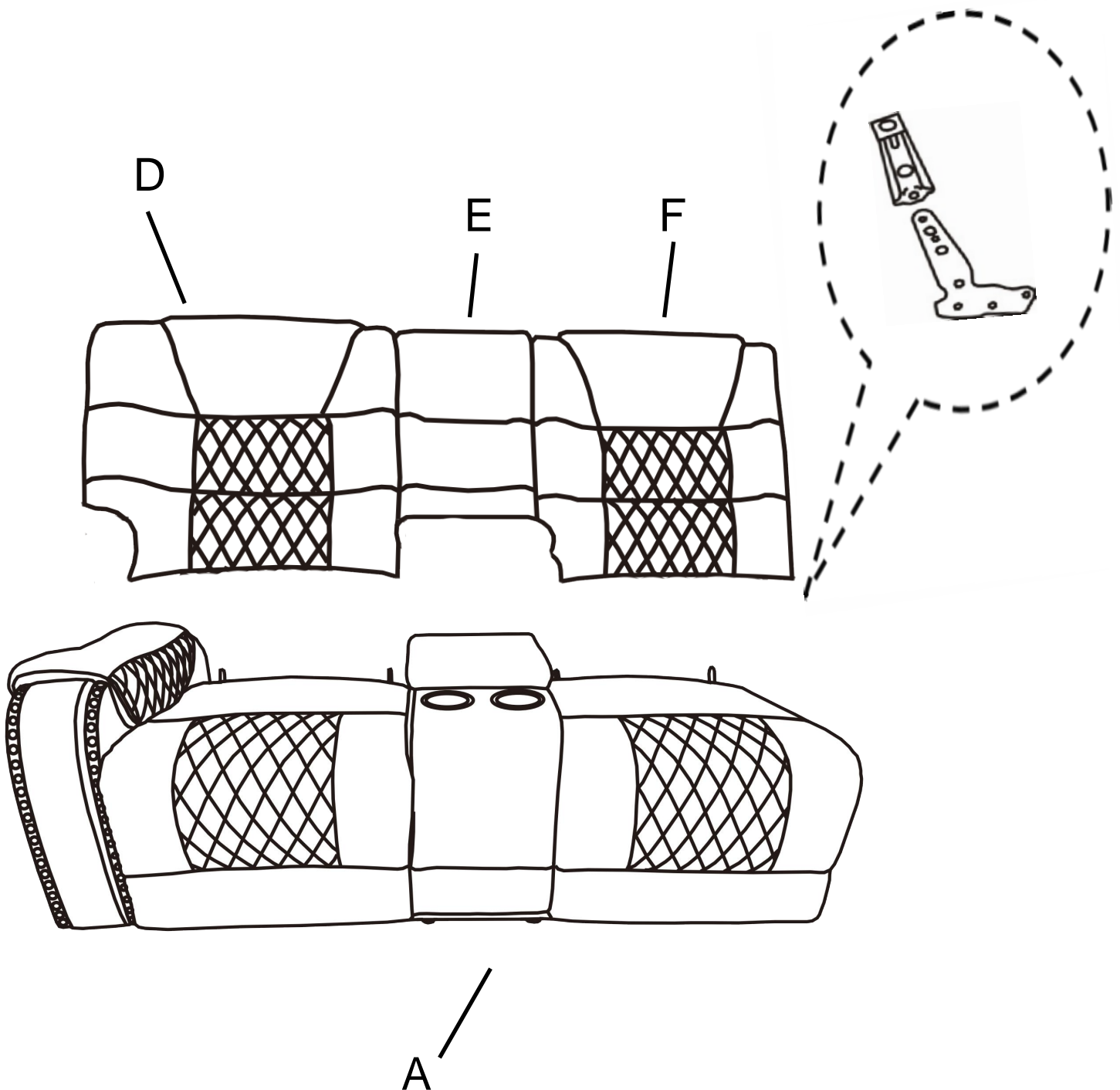

**Step3:**

Install the Corner back (G), kests of the seat (C).  
Please make sure the brackets and console back are inserted all the way and secured into position.

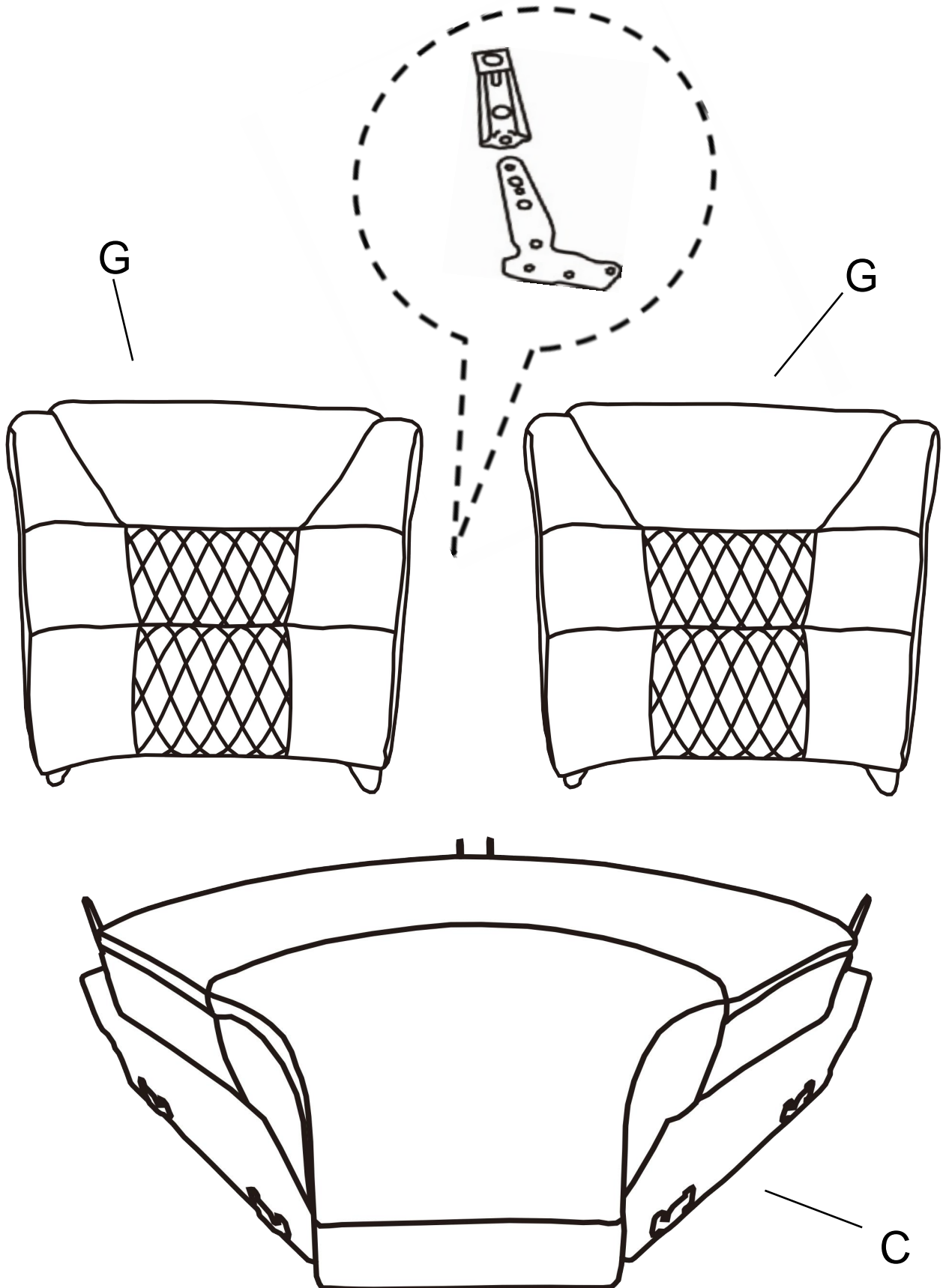

#### Step4:

Install the LSF backrest (F), Console back (E), and RSF backrest (H) by align and insert the metal bracket to the metal brackets of the seat (B). Please make sure the brackets and console back are inserted all the way and secured into position.

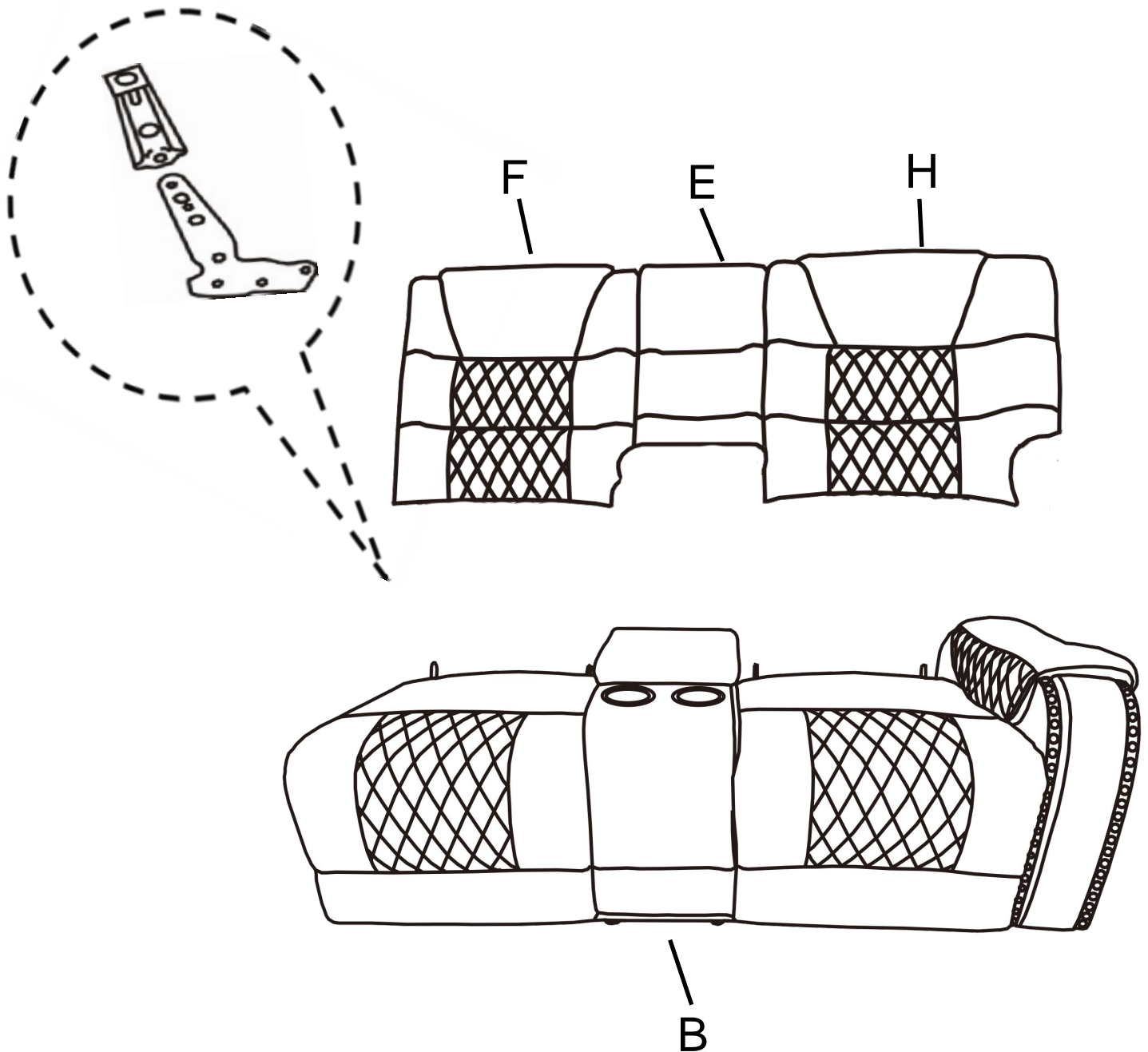

Step5:

Insert A to C, as shown.

Connect the power connector (K) located between the two seats

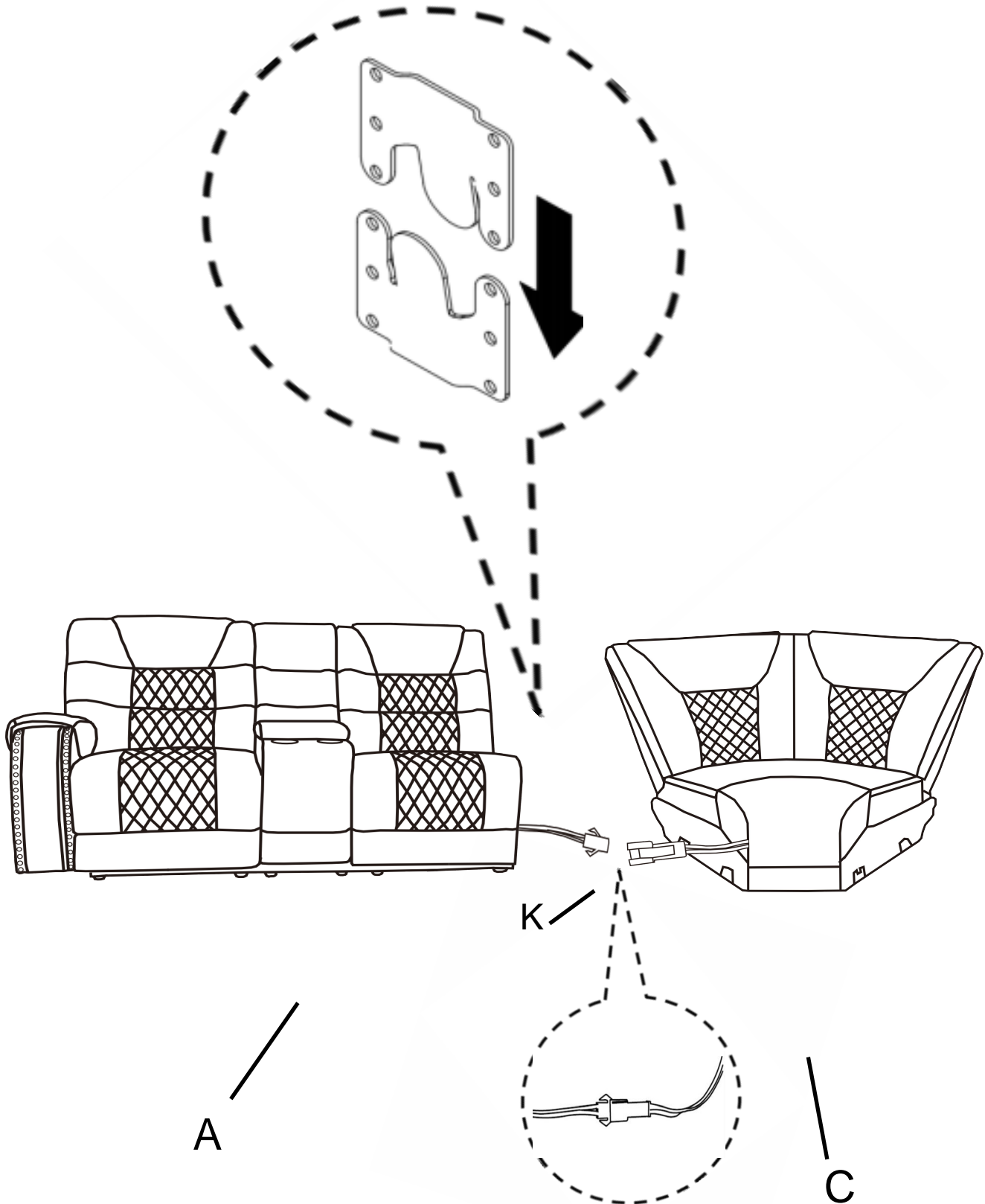

Step6:

Insert B to C, as shown.

Connect the power connector (K) located between the two seats

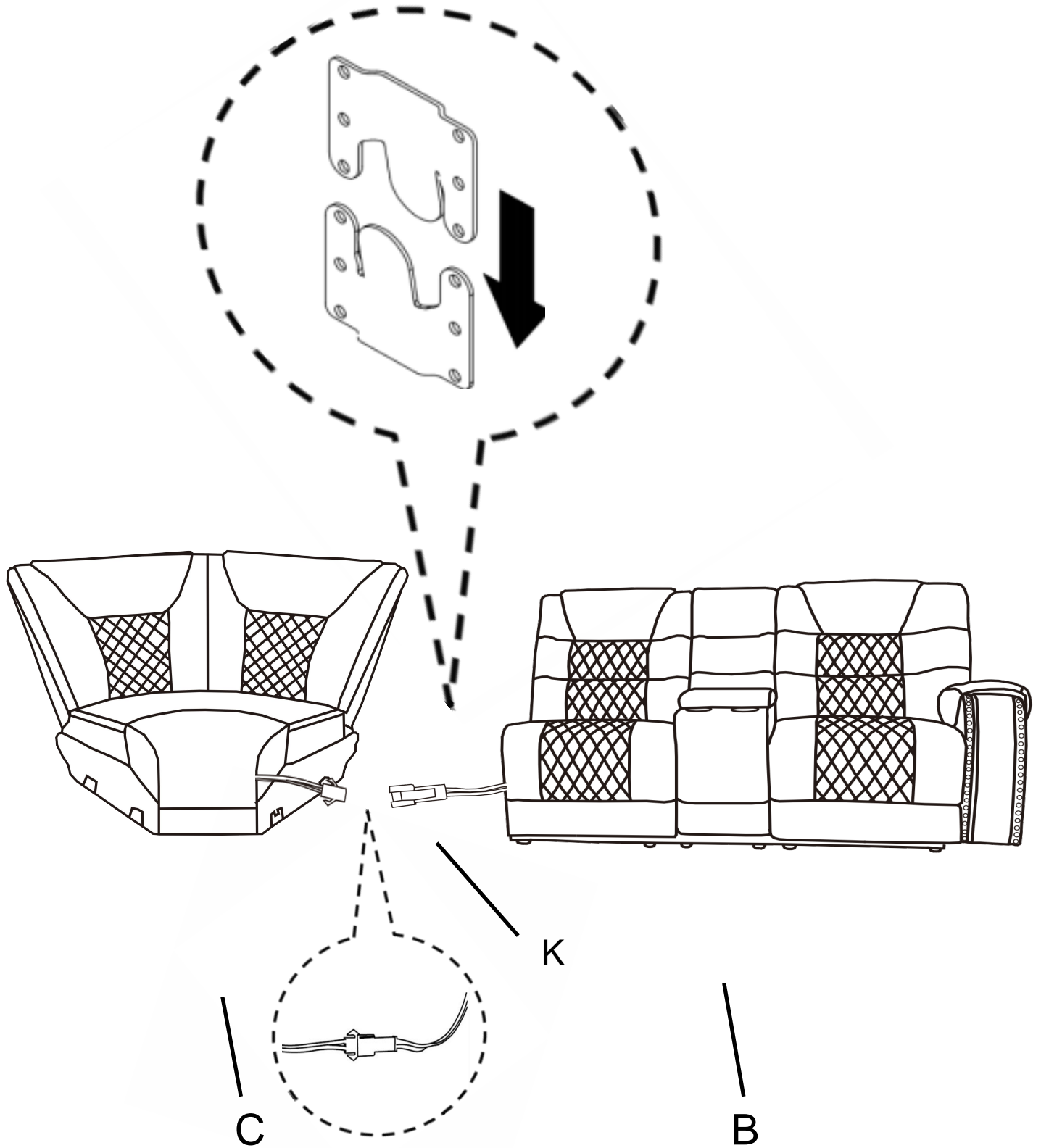

## Step7:

Install the the wings by inserting metal bracket on the LSF wing (I) and RSF wing (J) into the metal bracket on the backrest (A&B). Please make sure the brackets are inserted all the way and secured into position.

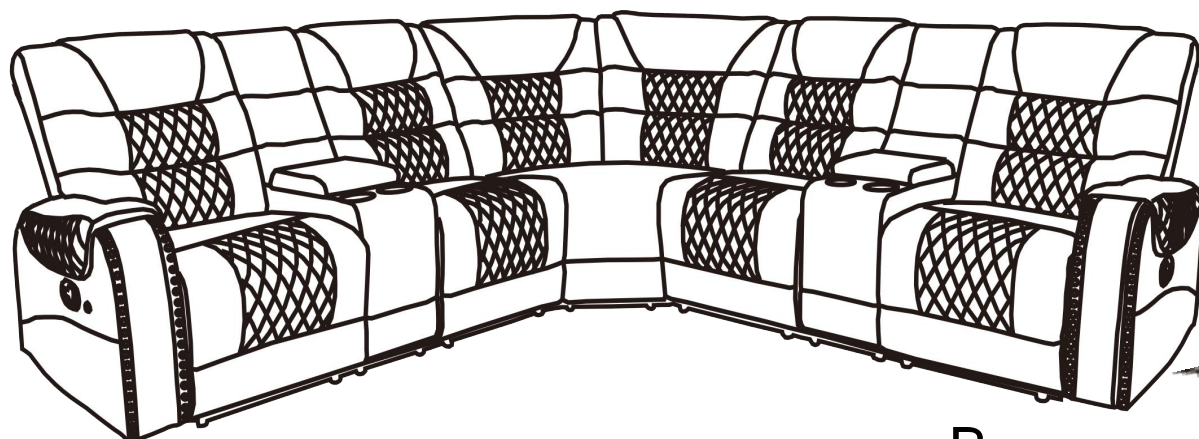

A

B

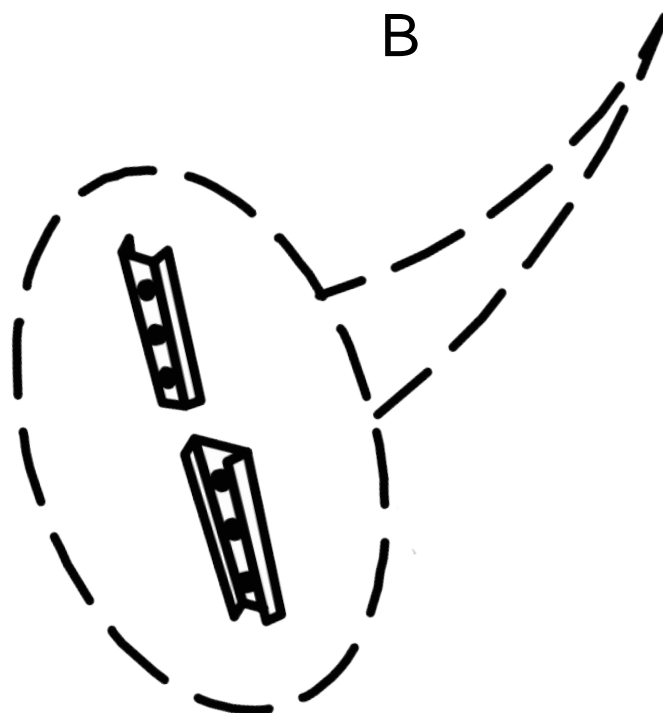

## Step 8:

Your product will look similar to this when assembly is complete.

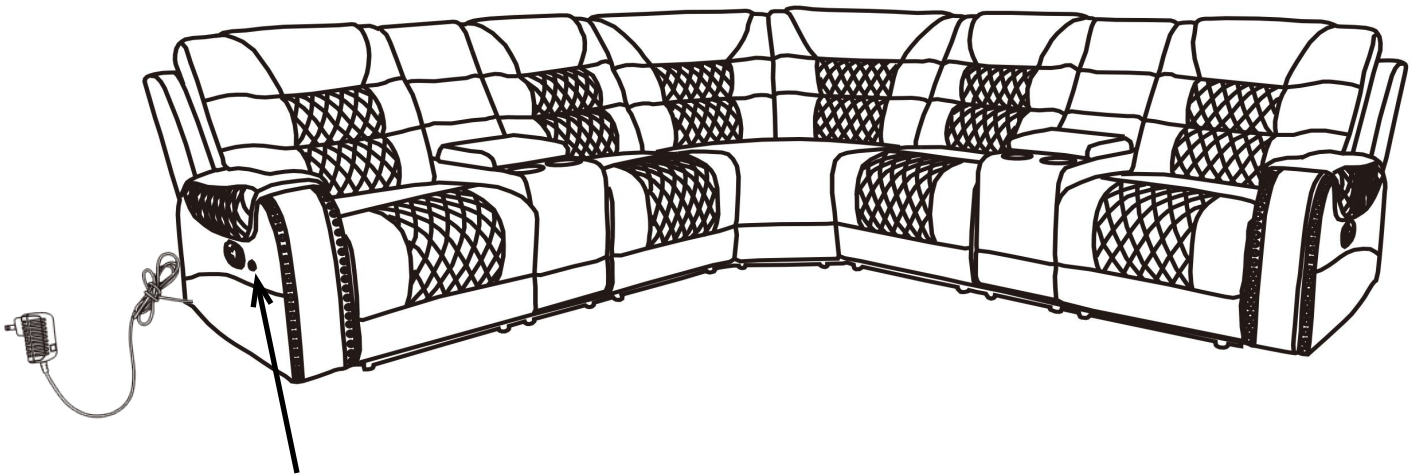

Light tape switch

Insert the plug into the power socket, press the light strip switch, and the LED light will light up