

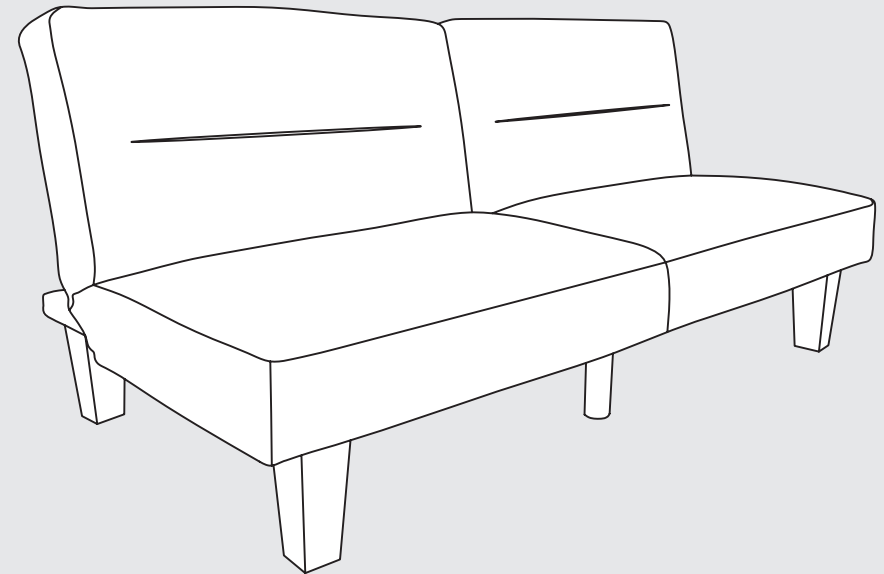

FINGER GUARD

- U.S. Patent No. 8,875,321
- Provides Users a Permanent Safety Solution
- Eliminates the Risk & Liability of an Accident
- Heavy Duty, Fully Welded, Protective Metal Plate

CONVERTIBLE SOFA



ADULT ASSEMBLY REQUIRED

If you are missing any parts or have any questions regarding assembly, do not return this item to the retailers store. Please call our toll-free, customer service number and have this assembly manual open to the parts list ready to provide the model name, number and part name or number.



WARNING: This product may contain small components, please ensure they are kept away from small children.

PARTS

Avoid using sharp objects such as a knife to cut open packing as you may accidentally damage the upholstery.

4 Enjoy your new convertible sofa.

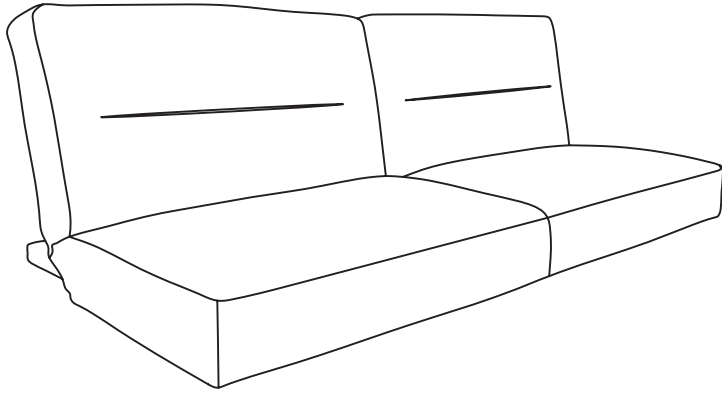

A. Sofa Body
1x

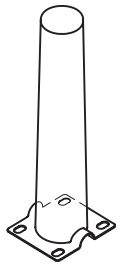

B. Center Support Leg
2x

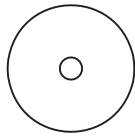

C. Plastic Disk
4x

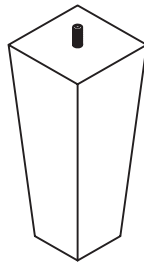

D. Legs
4x

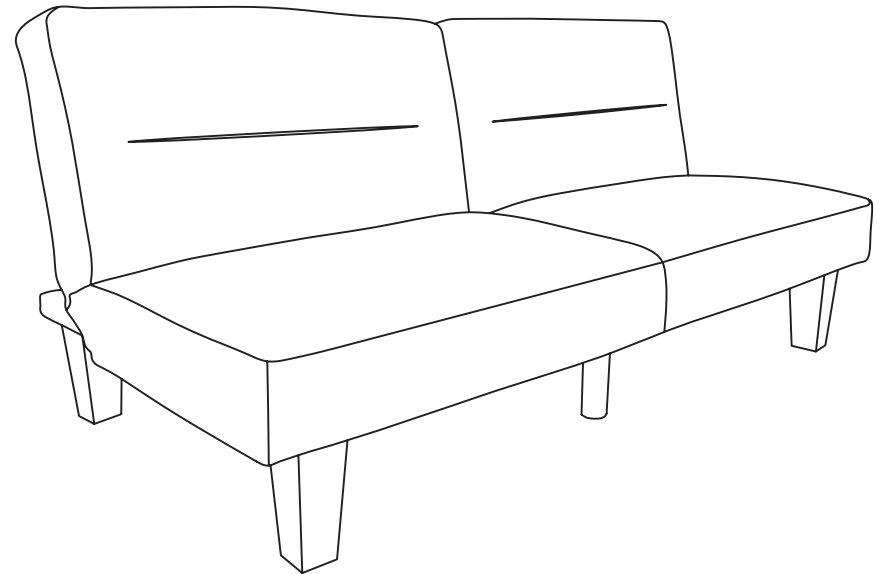

3 Operate your convertible sofa by pushing the backrest forward, this will release the sofa to the bed position. Lift the backrest up to transition from bed position to either lounge or sofa position. This sofa has a split back which will allow you to operate either the left or right side independently.

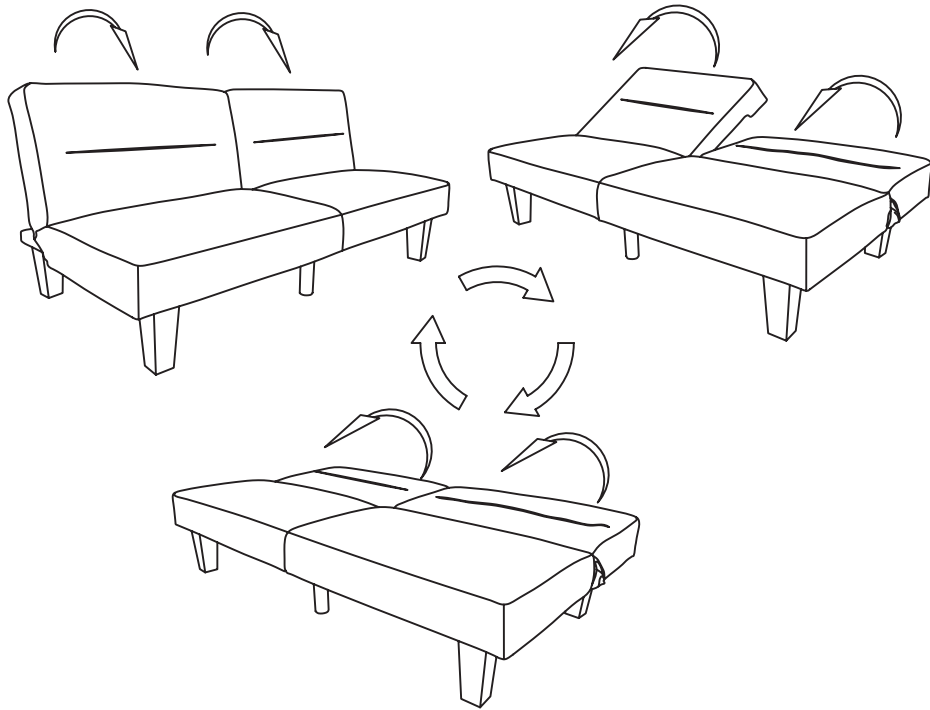

HARDWARE

Avoid using sharp objects such as a knife to cut open packing as you may accidentally damage the upholstery.

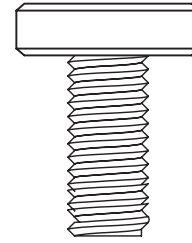

1. 1/4 x 3/8 Bolt
8x

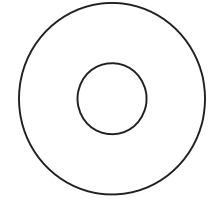

2. Washer
8x

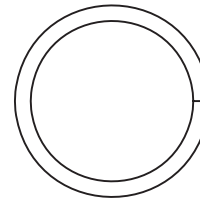

3. Lock Washer
8x

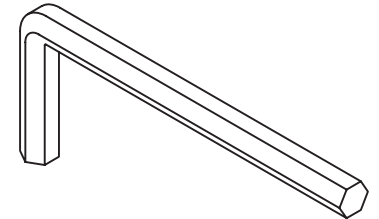

4. Allen Key
1x

ASSEMBLY INSTRUCTIONS

Do not fully tighten bolts until assembly is complete.

- 1** Flip Sofa Body (A) over.
Pull out Hardware and Parts from the zippered compartment.

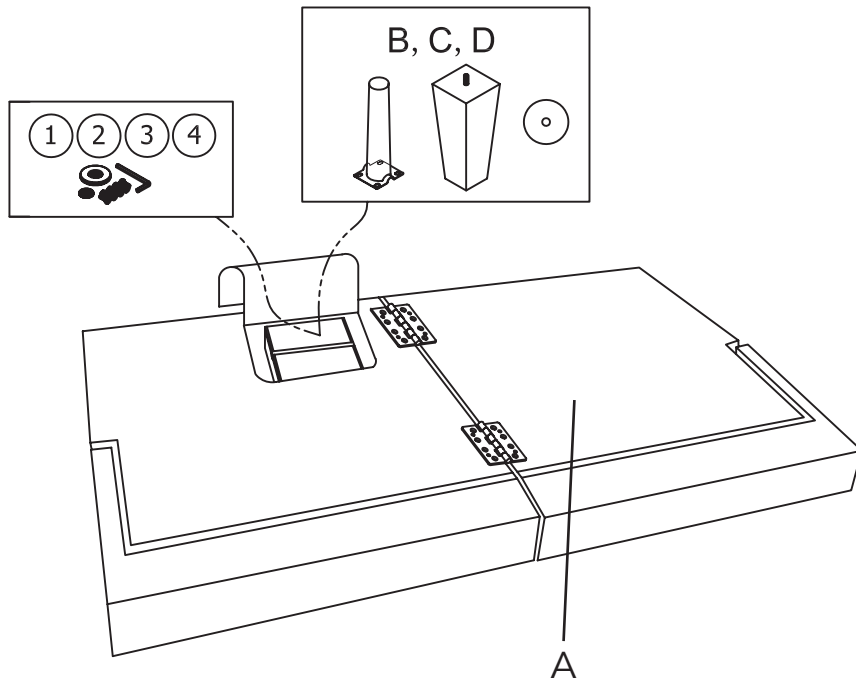

- 2** Attach Legs (C) to Sofa Body (A) using Plastic Disk (D) and hand turning until tight.

Then attach Center Support Leg (B) to Sofa Body (A) using Bolt (1), Lock Washer (3) and Washer (2). Tighten using provided Allen Key (4).

