



**INSTRUCTIONS D'ASSEMBLAGE  
ASSEMBLY INSTRUCTIONS**

---

---

**BUREAU -  
58"L / FAUX MARBRE BLANC DE COIN / METAL  
NOIR**

**COMPUTER DESK -  
58"L / WHITE MARBLE / BLACK METAL CORNER**



**POUR DE L'ASSISTANCE OU POUR COMMANDER  
DES PIÈCES CONTACTEZ NOTRE DÉPARTEMENT  
DE SERVICE À LA CLIENTÈLE.**

**FOR ASSISTANCE OR TO ORDER PARTS  
CONTACT OUR CUSTOMER SERVICE DEPARTMENT**

**LISTE DES PIÈCES**  
**PARTS LIST**

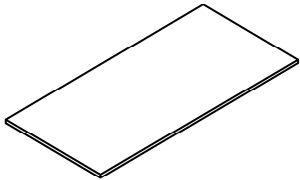
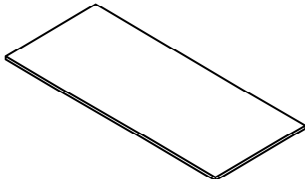
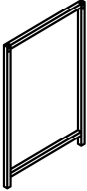
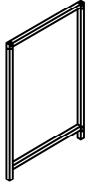
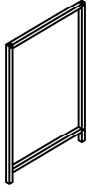
PIÈCE / PART #	IMAGE	DESCRIPTION	QTY / QTÉ
1		DESK TOP SURFACE DU BUREAU	1
2		DESK TOP SURFACE DU BUREAU	1
3		LEG PATTE	1
4		FRONT FACING LEFT LEG PATTE AVANT GAUCHE	1
5		FRONT FACING RIGHT LEG PATTE AVANT DROITE	1

**LISTE DES PIÈCES**  
**PARTS LIST**

PIÈCE / PART #	IMAGE	DESCRIPTION	QTY / QTÉ
<b>6</b>		CONNECTOR CONNECTEUR	1
<b>7</b>		CONNECTOR CONNECTEUR	1
<b>8</b>		CONNECTOR CONNECTEUR	1
<b>9</b>		CONNECTOR CONNECTEUR	1
<b>10</b>		CONNECTOR CONNECTEUR	1

## LISTE DES PIÈCES DE MONTAGE HARDWARE LIST

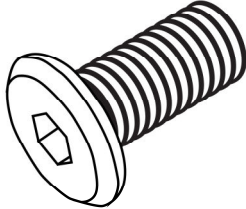
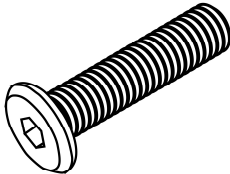
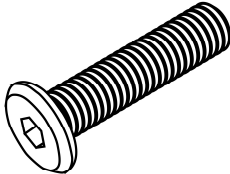
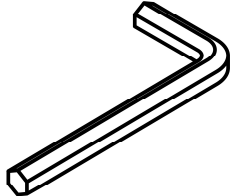
PIÈCE / PART #	IMAGE	DESCRIPTION	QTY / QTÉ
<b>A</b>		<b>ASSEMBLING BOLT - Ø 1/4" X 1/2"</b> <b>BOULON D'ASSEMBLAGE - Ø 1/4" X 1/2"</b>	<b>9</b>
<b>B</b>		<b>ASSEMBLING BOLT - Ø 1/4" X 1 1/8"</b> <b>BOULON D'ASSEMBLAGE - Ø 1/4" X 1 1/8"</b>	<b>20</b>
<b>C</b>		<b>ASSEMBLING BOLT - Ø 1/4" X 1 1/2"</b> <b>BOULON D'ASSEMBLAGE - Ø 1/4" X 1 1/2"</b>	<b>1</b>
<b>D</b>		<b>HEX KEY - M4, 3M</b> <b>CLÉ HEXAGONALE - M4, 3M</b>	<b>1</b>



OUTIL DE VÉRIFICATION DE DIMENSIONS DES PIÈCES  
HARDWARE DIMENSIONS VERIFICATION TOOL



ÉTAPE / STEP 1

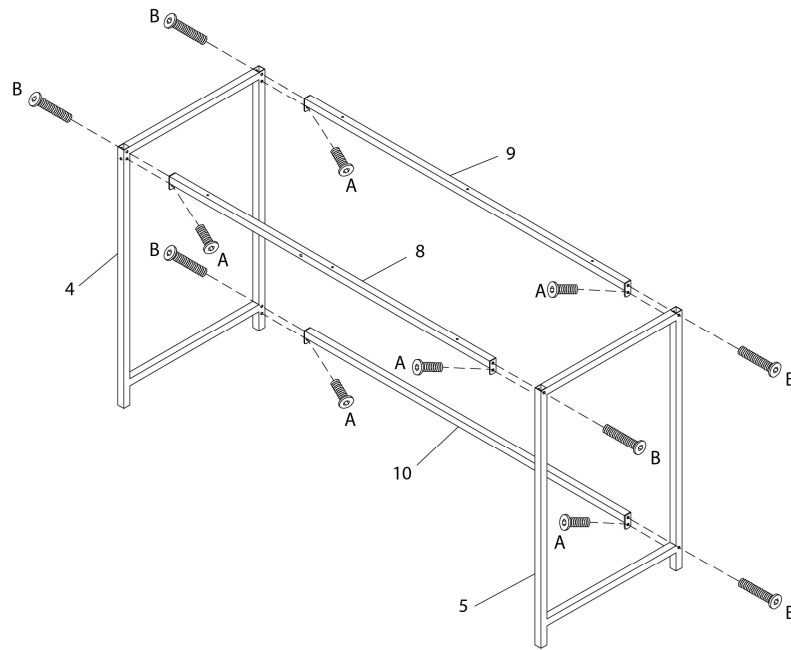

ÉTAPE / STEP 2

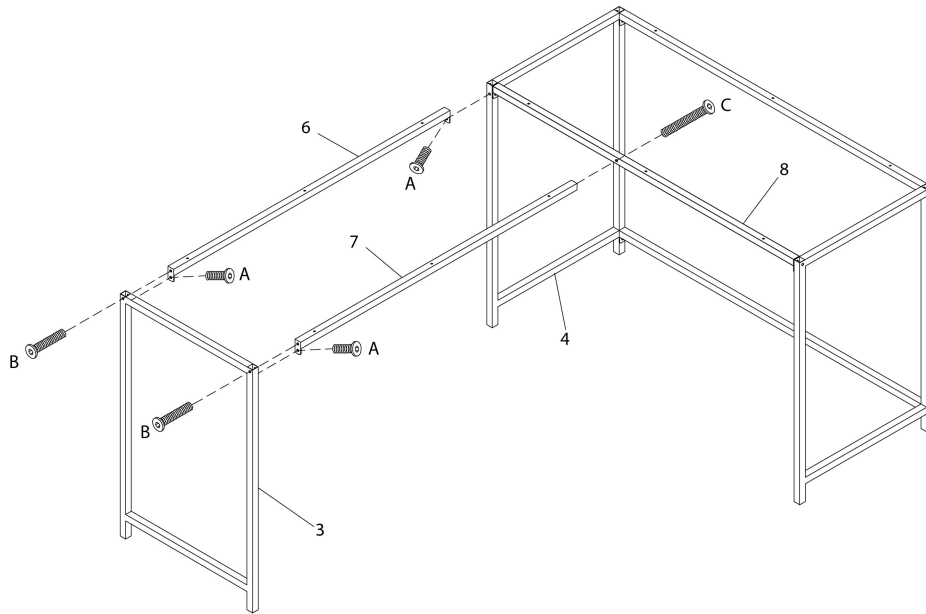

**ÉTAPE / STEP 3**

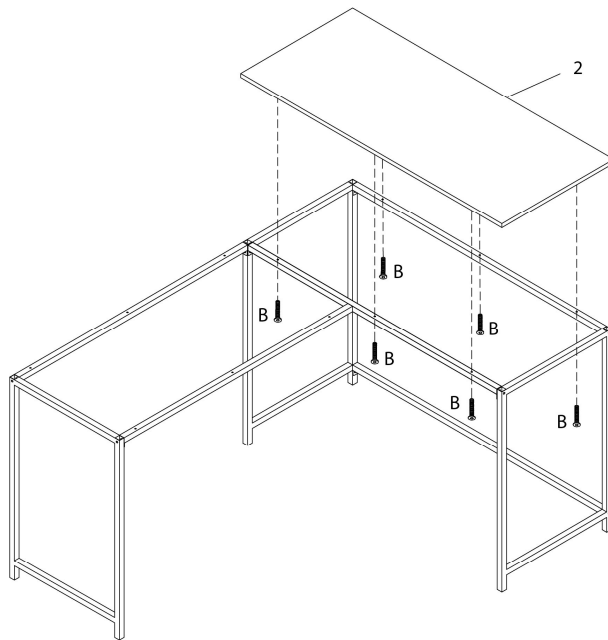

**ÉTAPE / STEP 4**

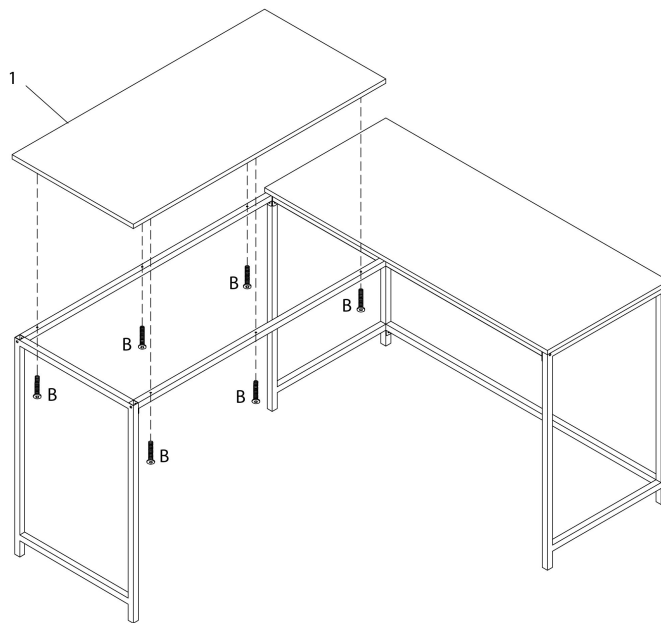

ÉTAPE / STEP 5

