

- (PL) INSTRUKCJA MONTAŻOWA
- (D) MONTAGENLEITUNG
- (GB) ASSEMBLY INSTRUCTIONS
- (SK) NÁVOD NA MONTÁŽ
- (CZ) MONTÁŽNÍ NÁVOD
- (IT) ISTRUZIONI DI ASSEMBLAGGIO
- (FR) NOTICE DE MONTAGE

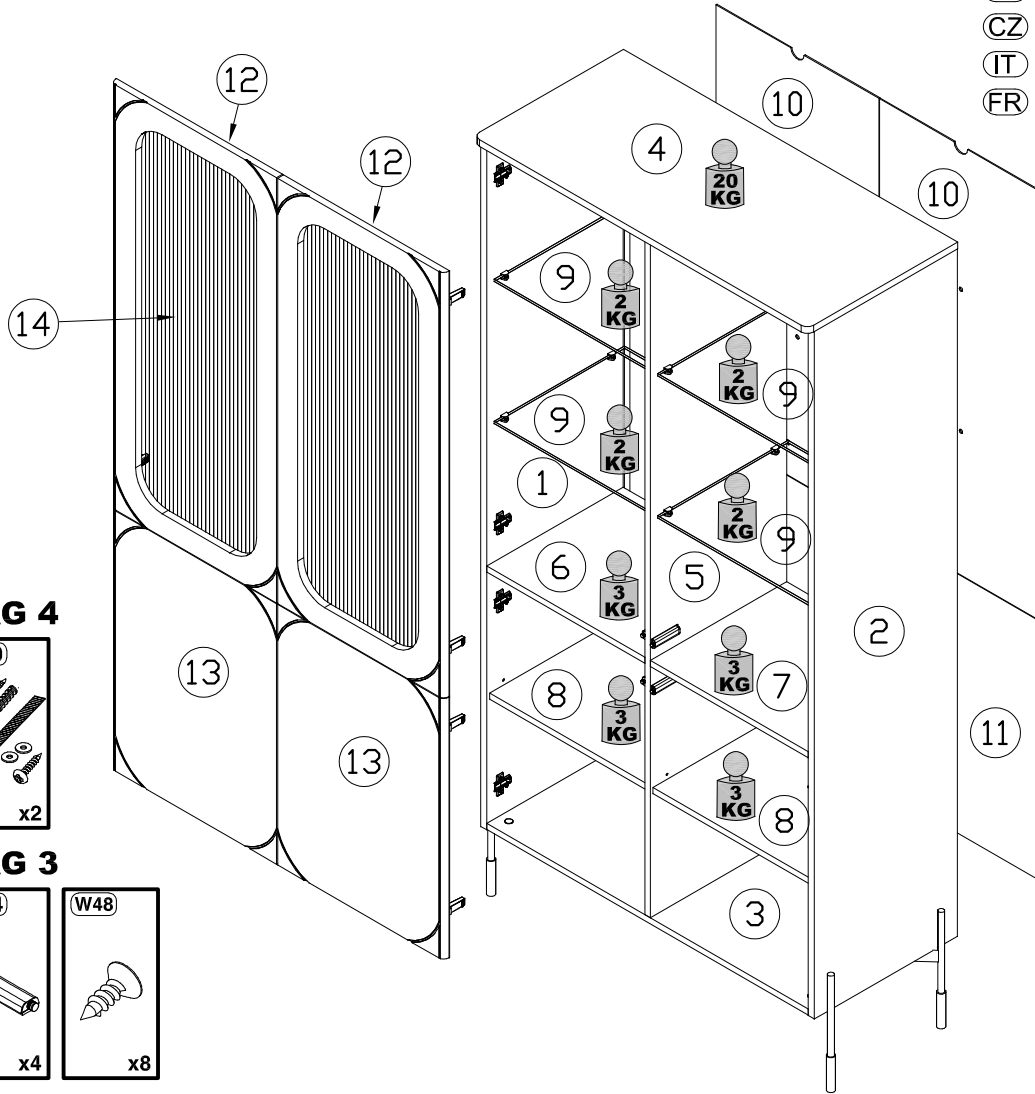

Do montażu potrzebne są:
Für die Montage dieser Type benötigen Sie:
For assembly you need:
Pour le montage, vous avez besoin de :

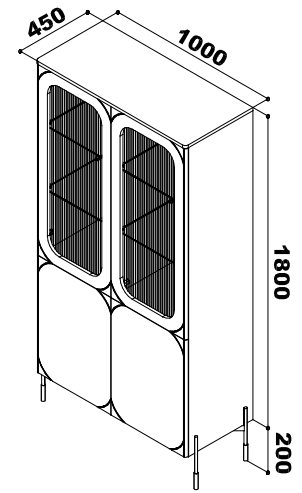
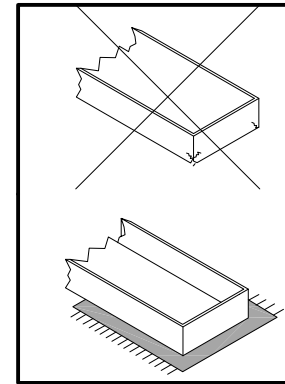
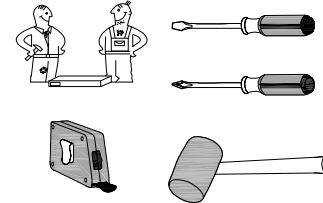

BAG 4



BAG 3

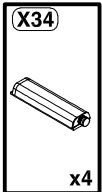

BAG 1

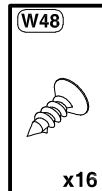
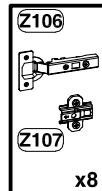
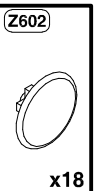
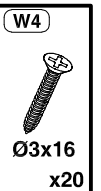
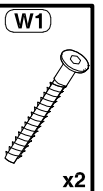
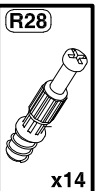
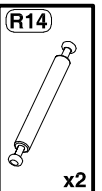
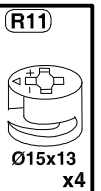
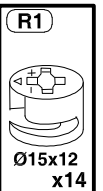
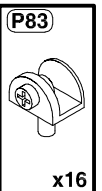
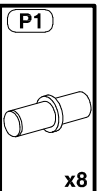
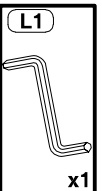
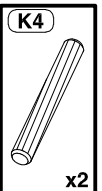
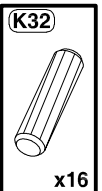
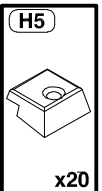
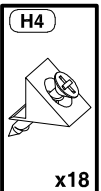
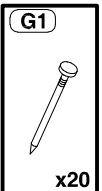
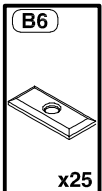

BAG 2

PL Szanowny Kliencie. Gdyby brakowało jakiejś części lub była by uszkodzona, to proszę oznaczyć część krzyżykiem na instrukcji montażowej i przesłać instrukcję razem z reklamacją.

D Sehr geehrter Kunde. Sollte ein Teil fehlen oder beschädigt sein, kreuzen Sie bitte dieses deutlich auf der Montageanleitung an und schicken Sie zu uns ab.

GB Dear customer. Should there be any place missing or damaged, kindly mark this place clearly on the attached assembly instructions and return it to us.

SK Vážený zákazník, keby chýball nejaká časť, alebo by bola poškodená, označte ju prosím krížikom na montážnom návode a zašlite návod spolu s reklamáciou.

CZ Vážený zákazníku kdyby chyběla nějaká část nebo byla poškozená, označte ji prosím křížkem na montážním návodu a zašlete návod spolu s reklamací.

IT Gentile cliente. In caso di parti mancanti o danneggiate, contrassegnare la parte con una croce sulle istruzioni di montaggio e inviare le istruzioni insieme al reclamo

FR Cher client, si une pièce est manquante ou endommagée, veuillez marquer la pièce d'une croix sur la notice de montage et envoyer la avec votre réclamation.

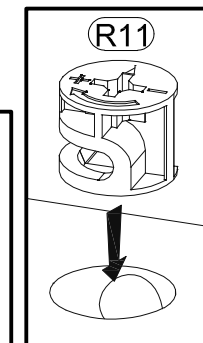
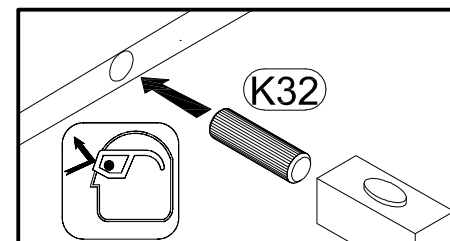
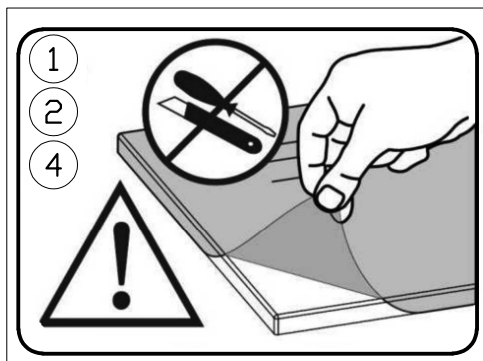
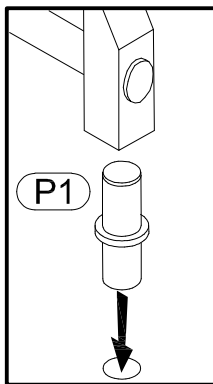
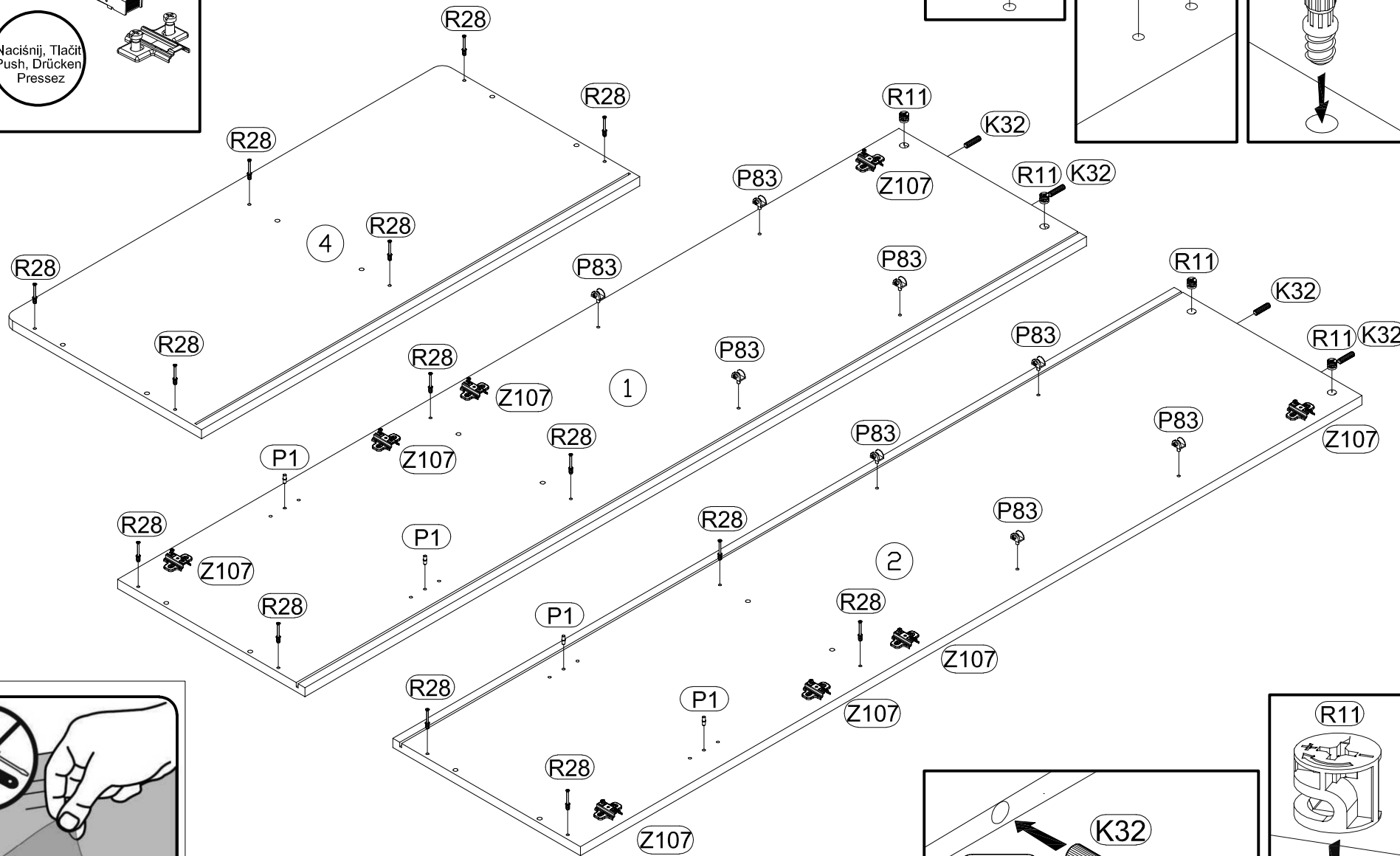
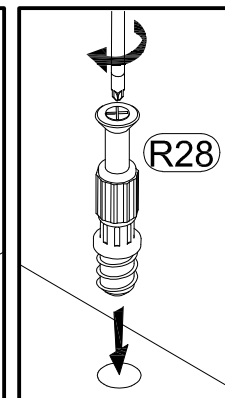
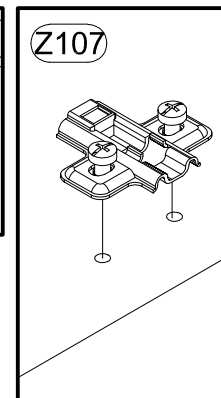
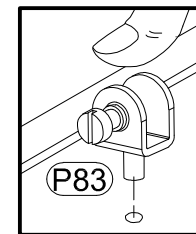
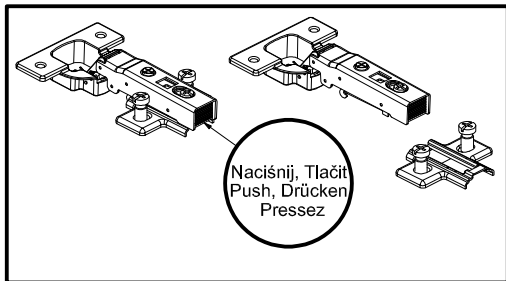

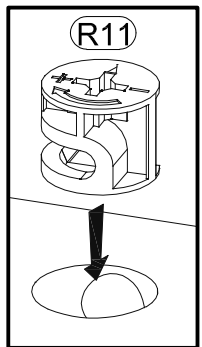
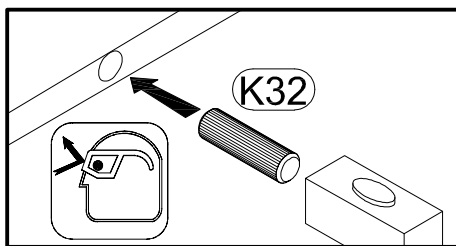
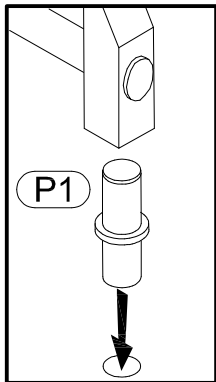
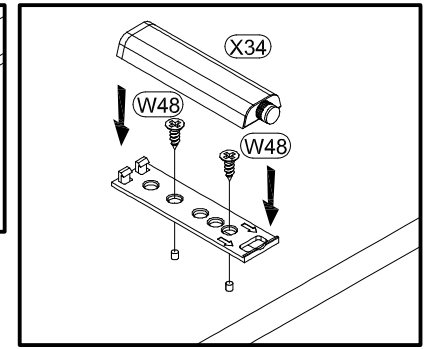
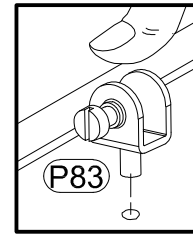
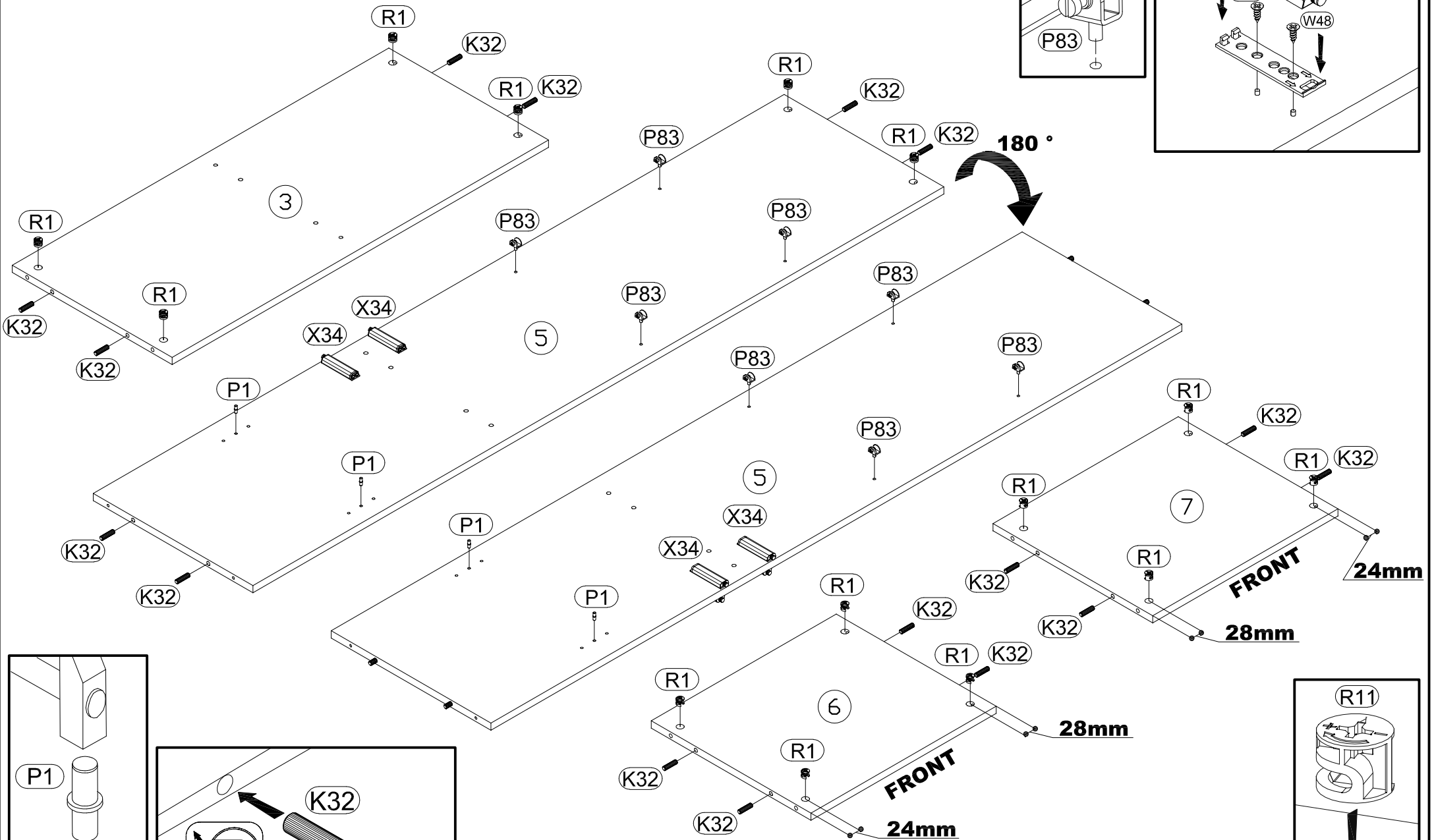

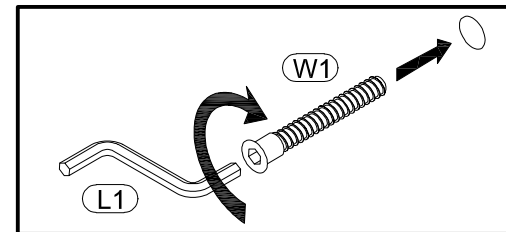
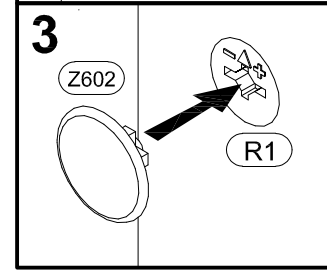
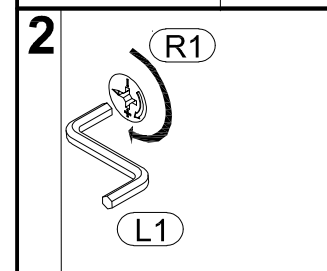
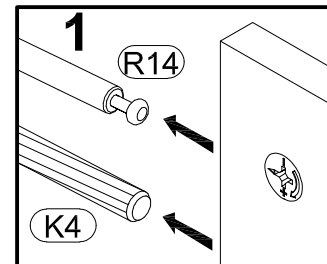
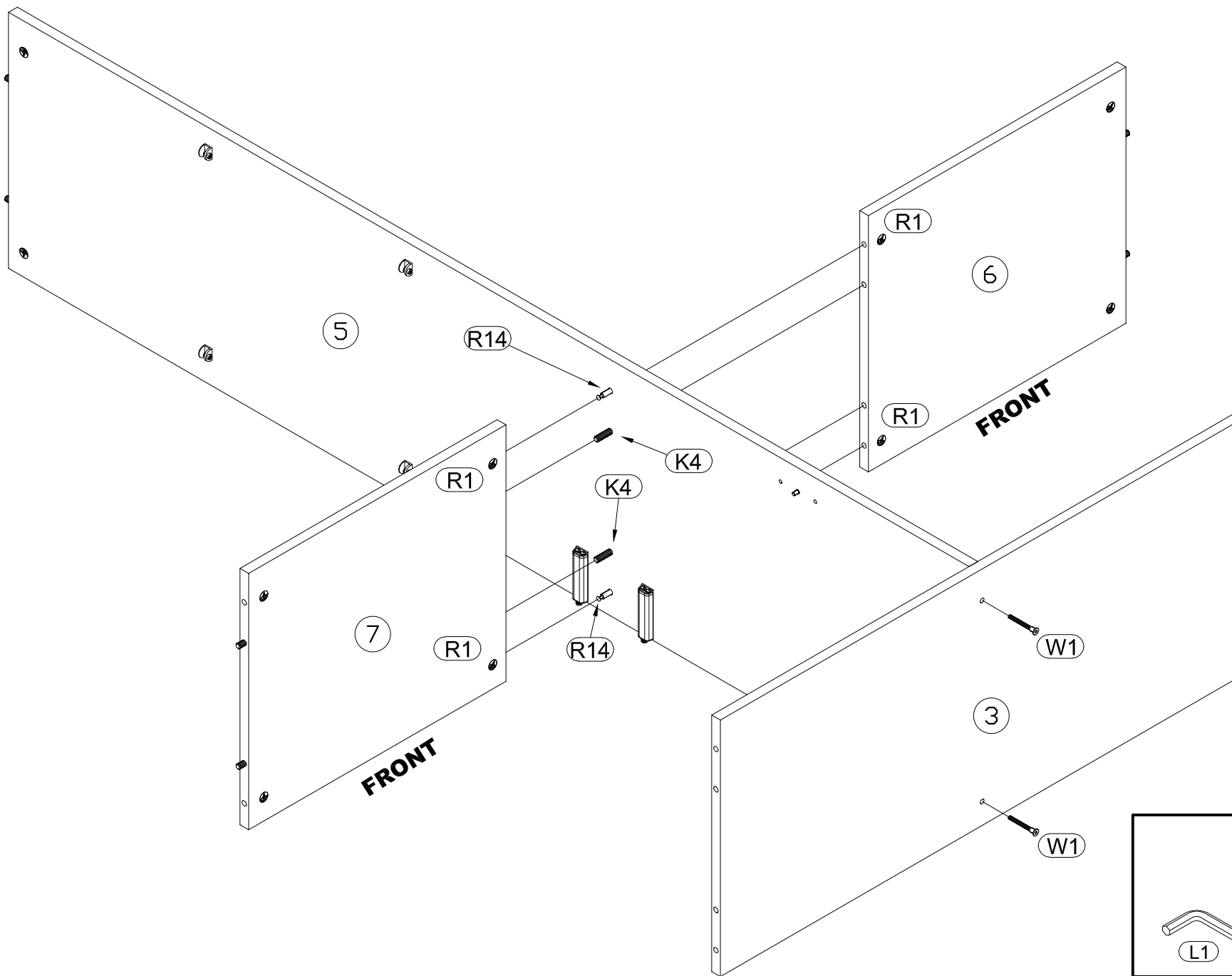

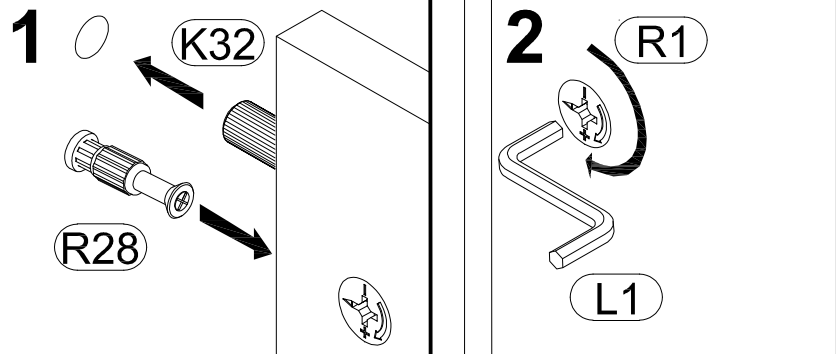
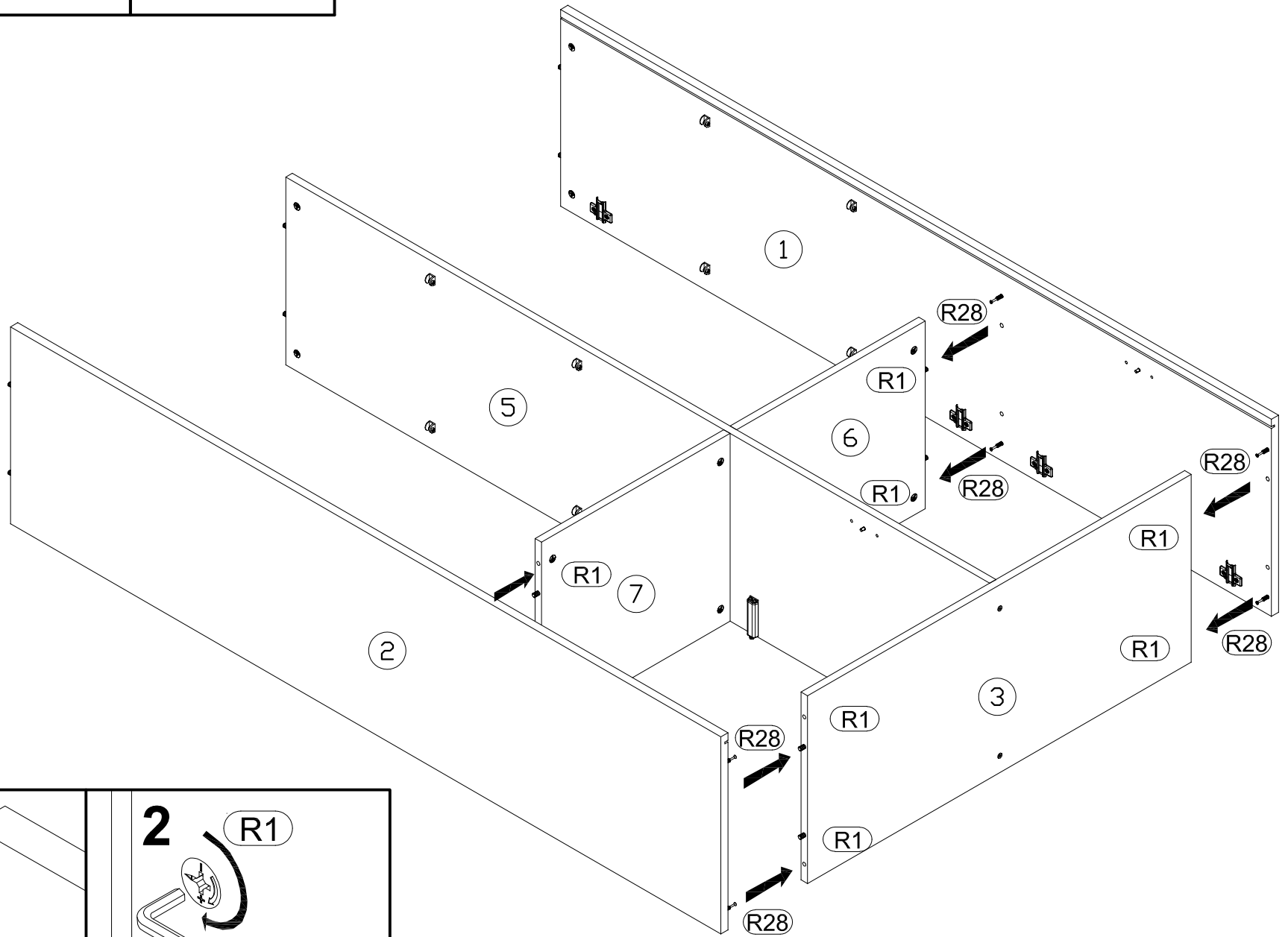

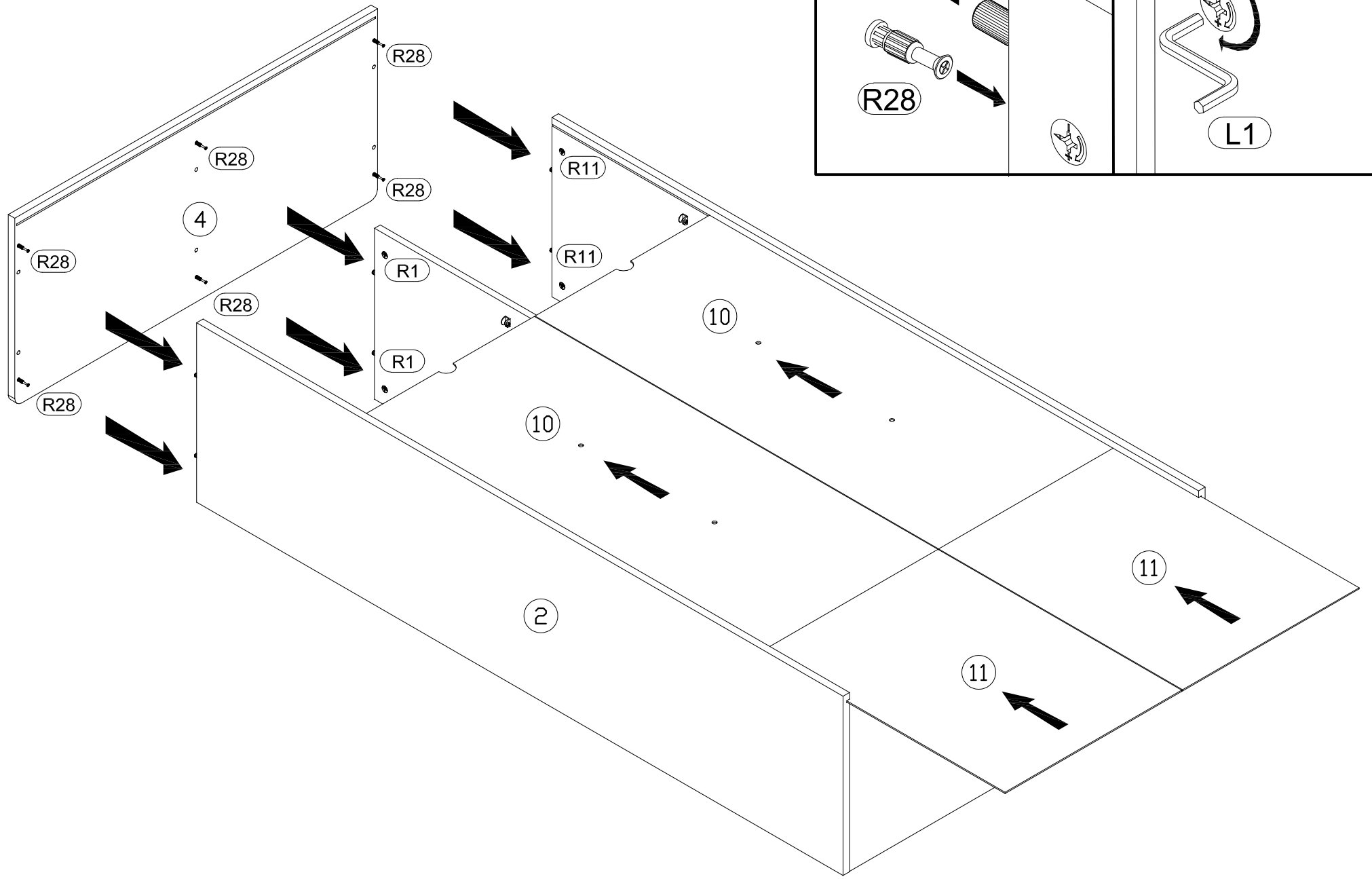
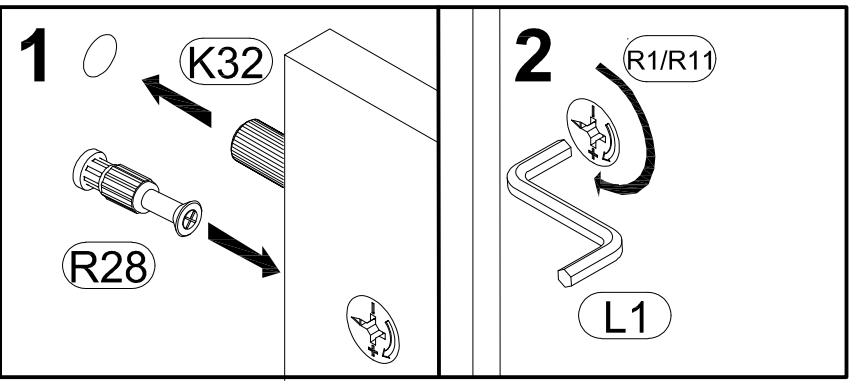

Bardzo ważne! Very important!
Sehr wichtig! Velmi důležitě!
Très important !

AB=CD AB>DC

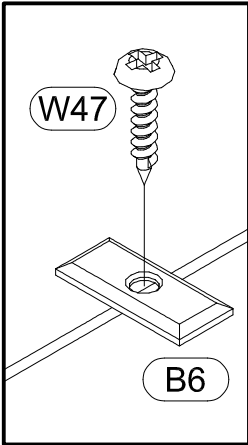
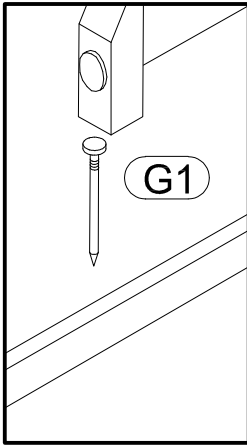
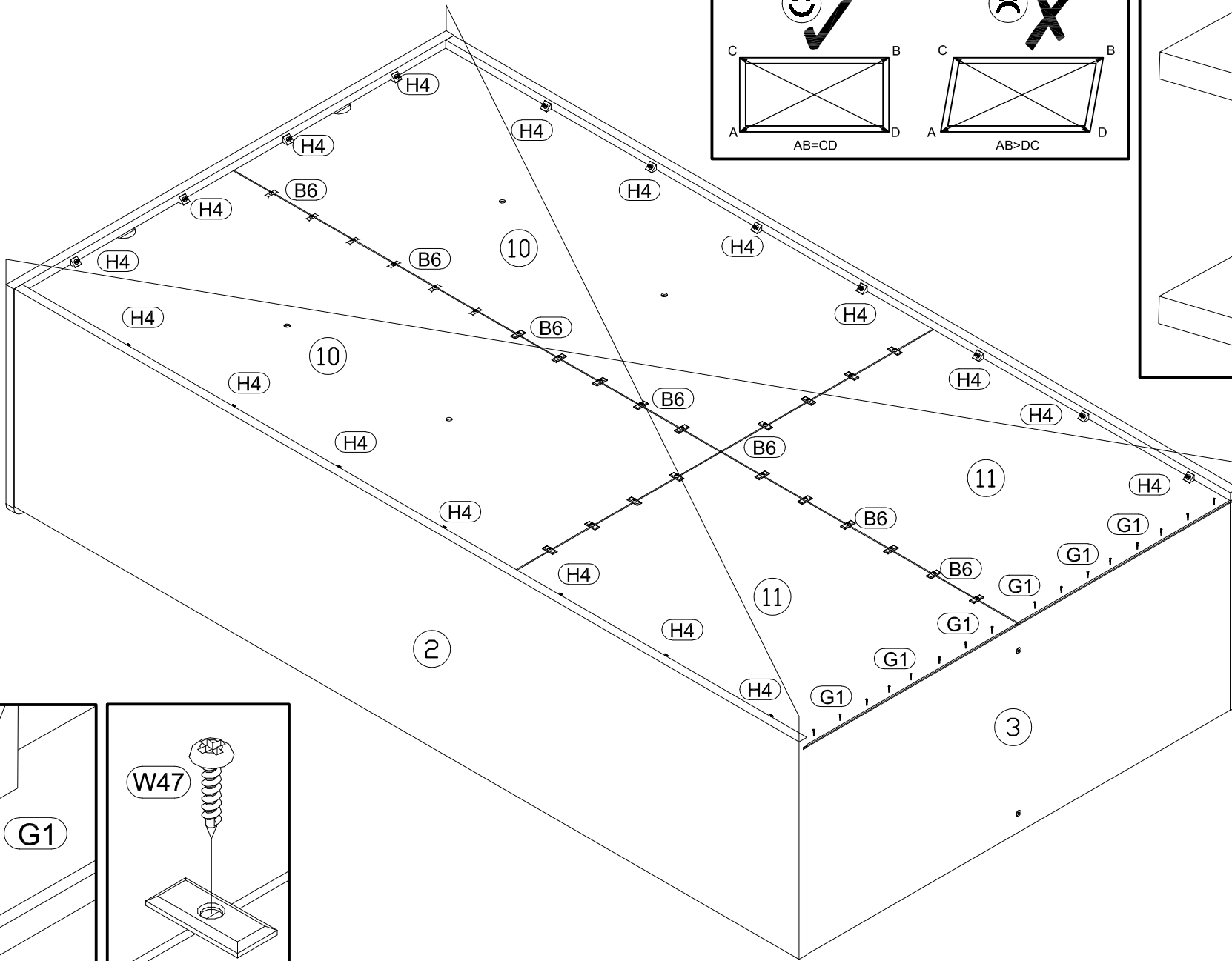
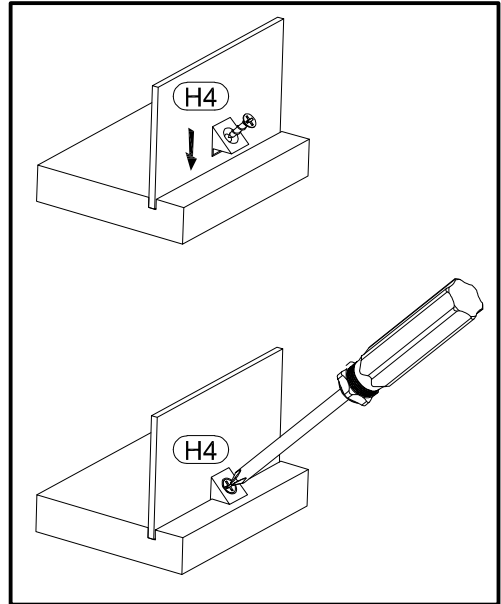

OPCJA I

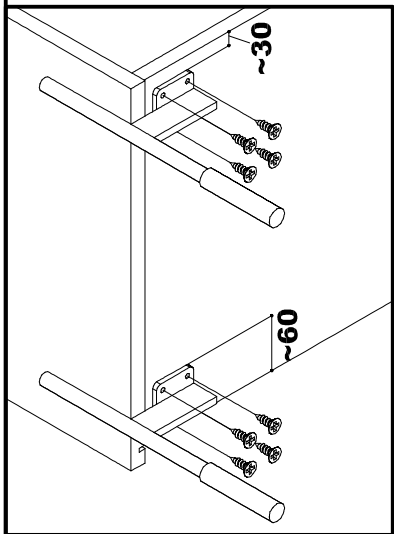
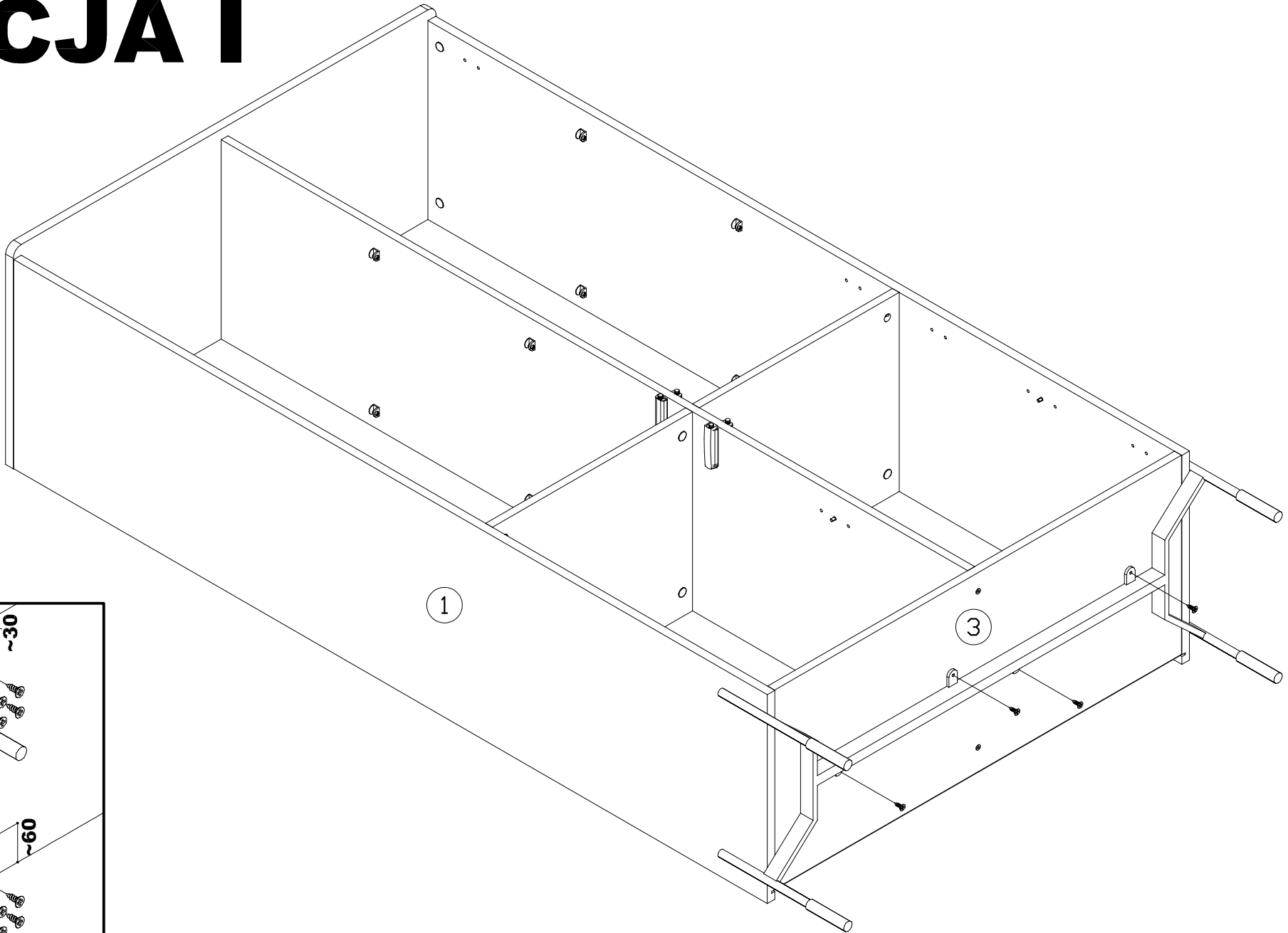

OPCJA II

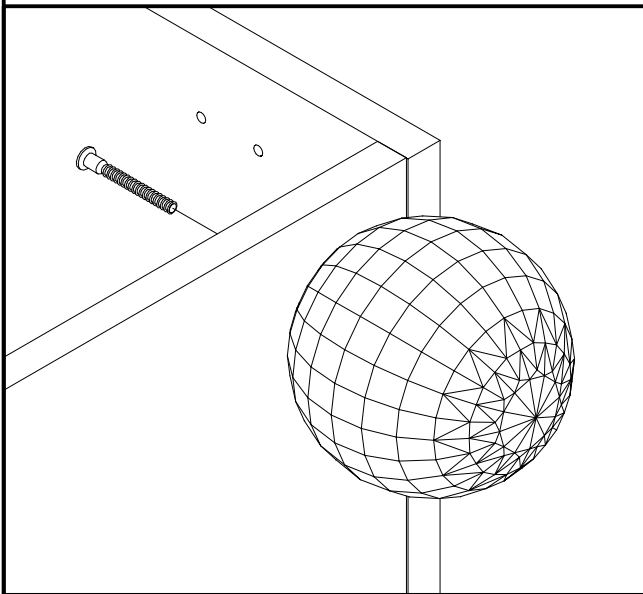
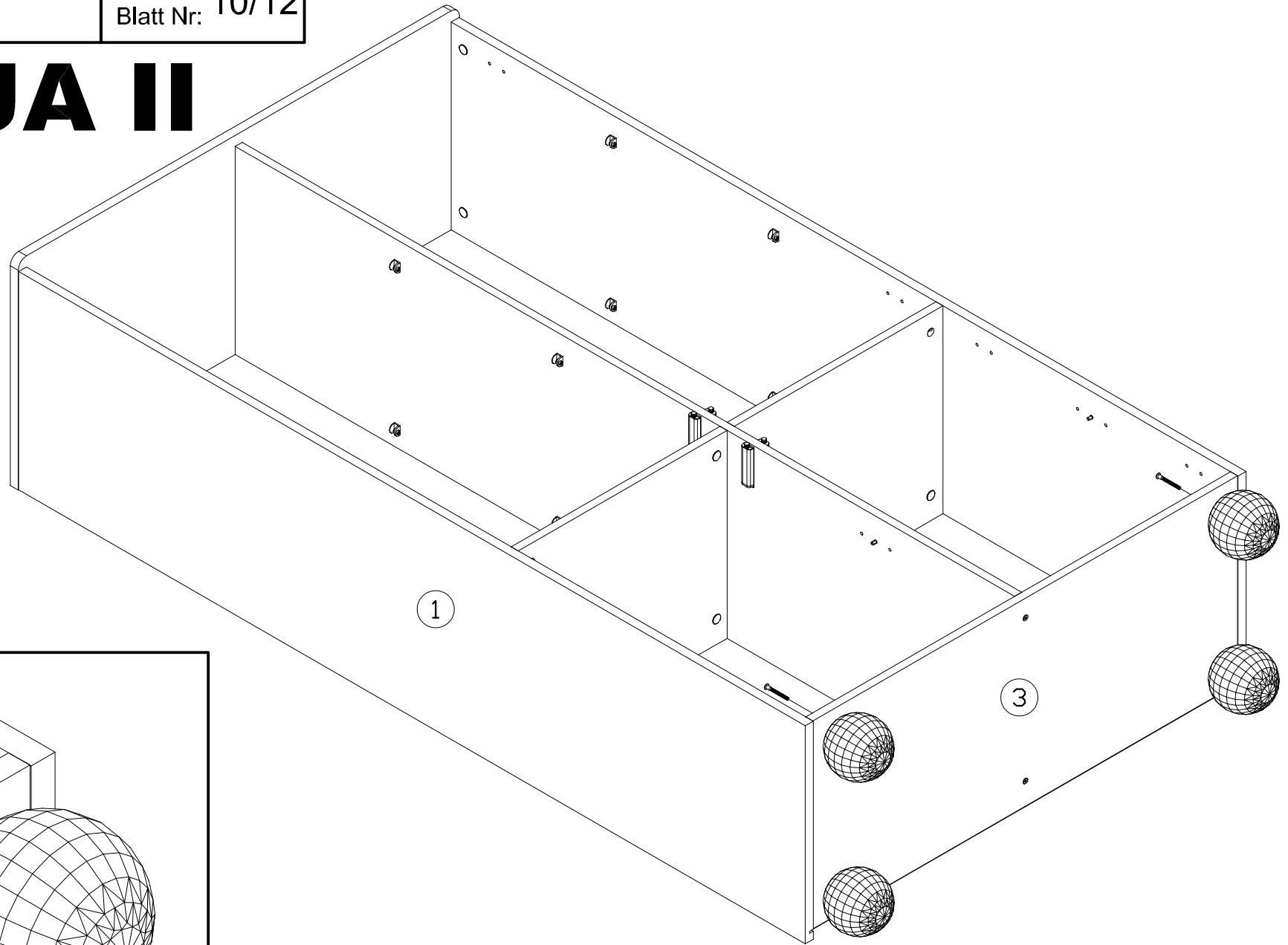

OPCJA LED

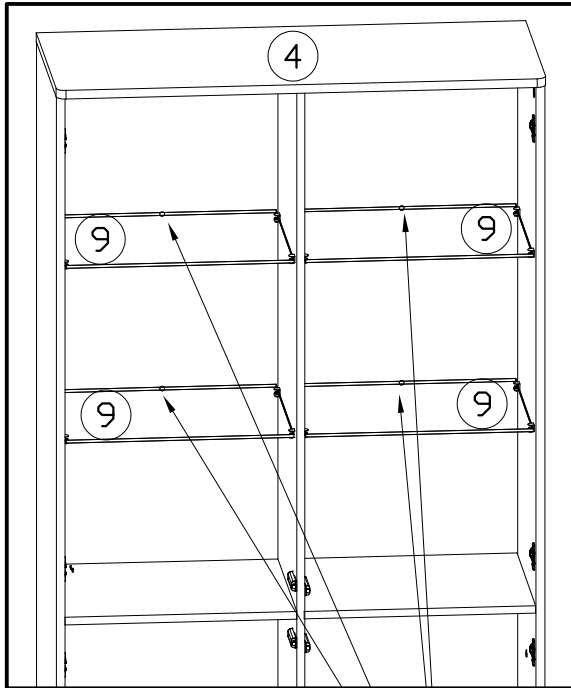
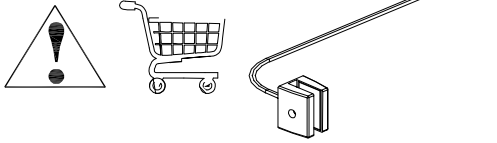

OPCJA LED

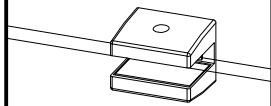

x4

