



# OUTPLAY THE ORDINARY

by Lausaint Home

V3.0



# HARDTOP GAZEBO INSTALLATION

## 10\*12FT

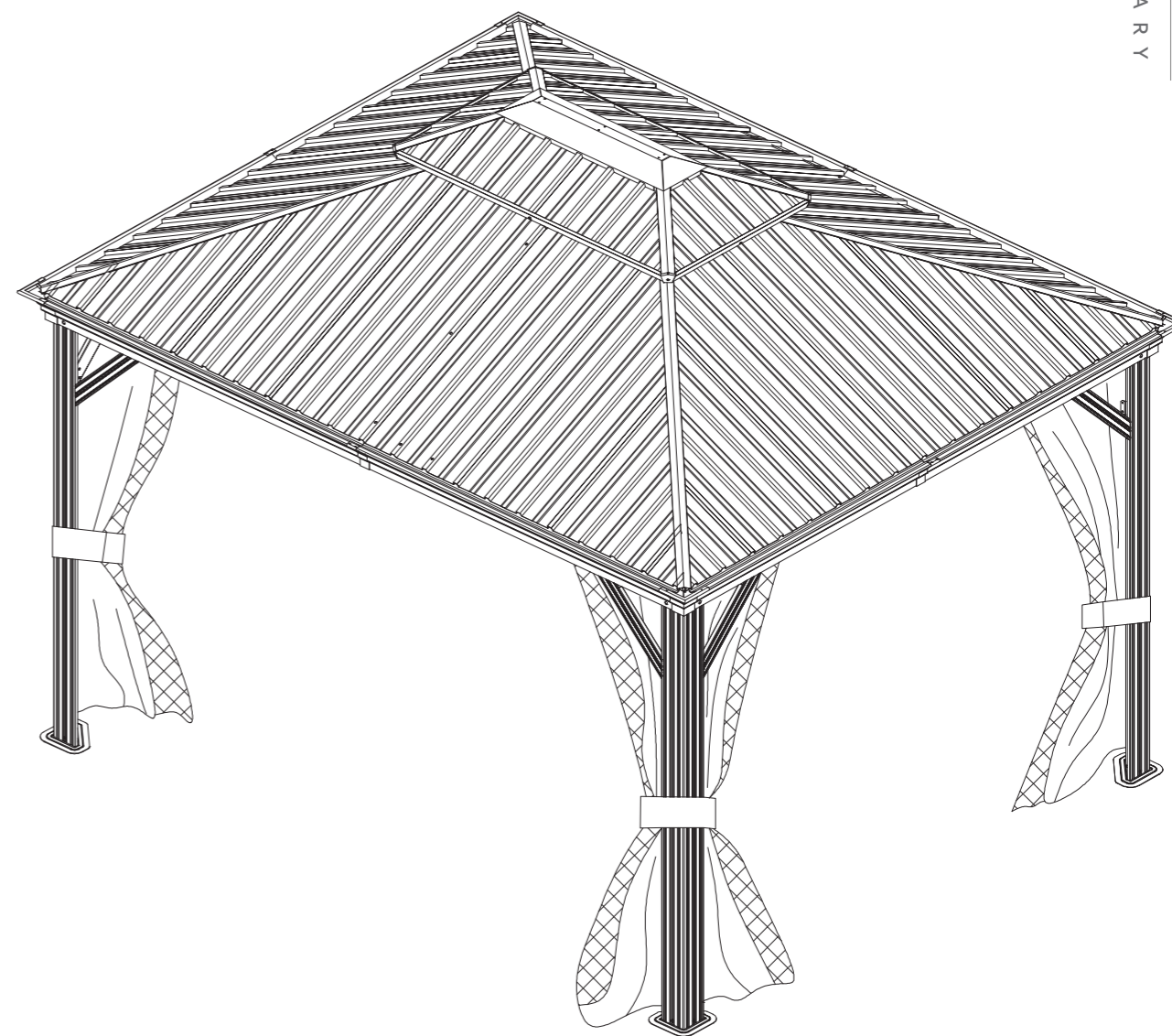

OUTPLAY THE ORDINARY

SKU GSM002-N01-S  
[customerservice@lausaint.com](mailto:customerservice@lausaint.com)

## INSTRUCTION BOOK



ATTENTION .....	02
IMPORTANT SAFETY INSTRUCTIONS .....	03
GENERAL PREPARATIONS .....	04
REQUIREMENTS TOOLS .....	05-08
COMPONENT LIST .....	09
HARDWARE LIST .....	10
ASSEMBLY STEPS .....	11-34
· BASE FRAME INSTALLATION .....	12-20
· TOP FRAME INSTALLATION .....	21-23
· TOP PLATE INSTALLATION .....	24-31
· ACCESSORY INSTALLATION .....	32-34
CARING FOR YOUR ITEM .....	35



**WARNING!**

**WARNING! TO REDUCE THE RISK OF SERIOUS INJURY, READ THE FOLLOWING SAFETY INFORMATION.**



**IMPORTANT SAFETY INSTRUCTIONS**

## **CAUTION!**

Always keep children under close supervision while they are playing around with this product. Never leave children unattended. Keep pets away while setting up the gazebo.

## **CAUTION!**

Check municipal by-laws before installing the gazebo.

- This product is intended for domestic outdoor use only.
- The product should be placed and assembled on flat, horizontal ground.
- Consult with your local governing authority/local municipal codes regarding the installation of temporary structures before assembly.
- Ensure there is enough clearance around the product. Before assembling the gazebo, make sure to leave a distance of not less than 6 ft (1.8 m) from any structures or obstructions, such as fences, garages, houses, overhanging branches, laundry lines, or electrical wires.
- Anchor the gazebo to the ground with stakes for added safety. Stakes are provided to secure the gazebo to the floor. If you wish to secure the gazebo to a concrete or wood surface, use anchors suited for these surfaces (anchors not included). Do not assemble the gazebo on sandy, muddy or loose soil, as stakes do not have enough anchorage in these types of soil.
- If more than one gazebo is set up, keep a minimum distance of 10 ft (3 m) between the gazebos.
- Any assembly or maintenance of the product must be carried out by adults only.
- Make sure there is sufficient manpower when assembling or moving the product.
- Some parts may contain sharp edges. Wear protective gloves if necessary.
- Check all nuts and bolts periodically to ensure their tightness. When required, tighten them.
- Repairing and replacing parts should be done by a qualified technician.
- This gazebo is intended for decorative purpose and to provide sunshade only.
- The gazebo is not designed to withstand harsh weather, including high winds, rain, and snow. Always remove the gazebo in such heavy weather conditions otherwise it might tip over and cause damage to the product or injuries to bystanders.
- During snow days, remove the snow at the top when the snow is thicker than 4 in (10 cm).
- After a period of time, usually in 2–3 months, tighten all the bolts.
- After some time outdoors, the gazebo roof may get dirty. Rinse the top of the gazebo using water. Do not use harsh cleaning agents.
- Do not hang any weights on the roof frame.
- Do not climb onto the roof of the gazebo. Falling off the gazebo can result in serious injury.
- Use paint of similar color for touch-ups. It is recommended to use outdoor paint.

## **CAUTION!**

- Proper placement of the gazebo is essential. Do not place the product underneath electrical lines.
- Keep children under close supervision while they are playing around with this product.
- This product contains small parts which can be swallowed by children.
- Keep fingers away from places where they can be pinched or trapped.
- Do not attempt to assemble the gazebo if any part is missing.
- Do not light any fires inside or near the product!
- Stay calm if a fire breaks out. Search for the nearest exit. Do not return to the gazebo until the fire department deems it safe.

## **LET US HELP YOU! DO NOT RETURN YOUR PRODUCT TO THE STORE.**

If you have questions regarding your product, require warranty assistance, or have damaged or missing parts, please contact us through this email [customerservice@lausaint.com](mailto:customerservice@lausaint.com). Contact us for assistance; we're here to help.

## **IMPORTANT**

Please read and understand this manual before any assembly!

We recommend at least three adults to complete the installation. Three adults installed together will make the installation process easier and safer.

Before beginning the assembly of the product, make sure all the component parts available.

Unpack and place all the parts from the packaging box in an open area and position them on the floor. Remove all packing materials and put them back into the box.

Do not dispose of the packing materials until assembly is complete. Read each step carefully before beginning any assembly, and make sure you understand each step. If you are missing a part, please contact us for assistance.

## **CAUTION!**

Disassemble the gazebo in reverse order of the steps used to assemble it.

Always disassemble the gazebo completely. A partially-disassembled gazebo is not stable enough to resist wind and bad weather, therefore can be damaged and/or cause damage.



- When choosing the location for your gazebo build, plan to have at least 6 ft (approximately 1.8 m) of clearance beyond the footprint of the gazebo to allow for installing parts. This is in conjunction with the Important Safety Instructions.
- It is very important that you install the gazebo on a flat, level surface. A surface that is not flat and level will make it difficult to square the frame, which will make assembly more difficult.
- Save your cardboard! You can use the box as padding when assembling the gazebo to prevent damage to parts during assembly.
- Lay out all parts before beginning assembly and compare the parts you have to the parts list in this manual. If parts are missing, please contact [customerservice@lausaint.com](mailto:customerservice@lausaint.com) to have replacement parts provided to you.
- Completely read through this assembly manual before beginning assembly so you can become familiar with the building process.



## PACKAGE NOT INCLUDED

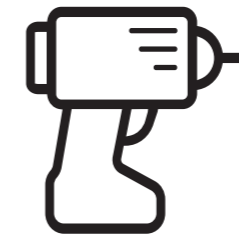

Electric Screwdriver

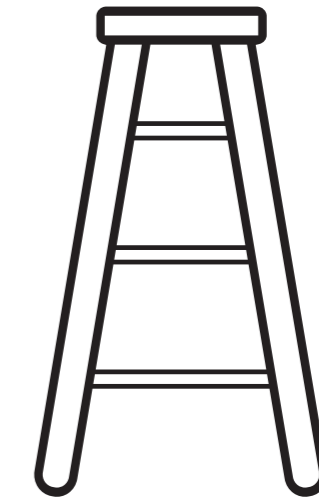

Ladder

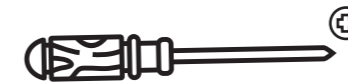

+ Manual Screwdriver







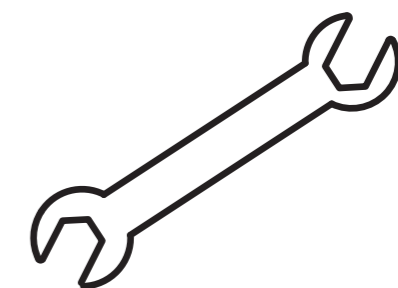

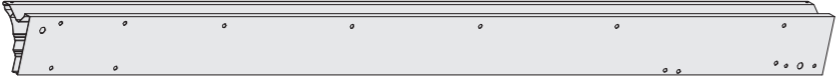

## TOOLS PACKAGE INCLUDE

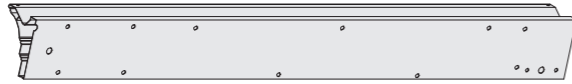
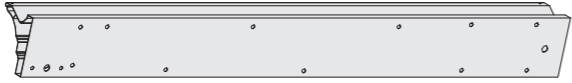

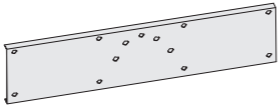

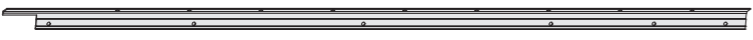

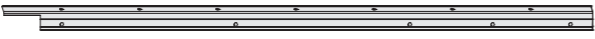





Gloves X 1 Pair

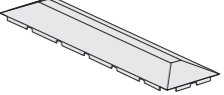
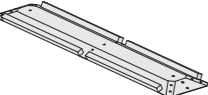

Spanner X 1

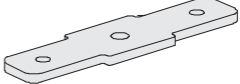
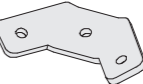
PARTS #	QTY	DESCRIPTION
A	4	
B	2	
B1	2	
B2	4	
C	2	
C1	2	
C2	4	
D	4	
E	4	
E1	4	
F1	2	
F2	2	
F3	2	
F4	2	

PARTS #	QTY	DESCRIPTION
H	4	
I	4	
J	2	
J1	2	
K	1	
K1	1	
L1	4	
L2	4	
M1	4	
M2	8	
M3	4	
M4	4	
R1	2	
R2	2	



# COMPONENT LIST

3

PARTS #	QTY	DESCRIPTION	PARTS #	QTY	DESCRIPTION
W	4		O2	2	
W1	4		O3	2	
W3	8		O4	2	
W4	8		O5	2	
N	2		P	2	
N1	2		P1	2	
N2	2		P2	2	
N3	2		P3	2	
N4	2		P4	2	
N5	2		P5	2	
N6	2		R	56	
N7	2		D1	16	
O	2		Z1	8	
O1	2		Wa	2	







4

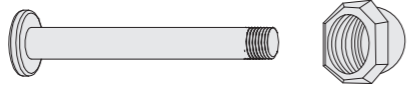
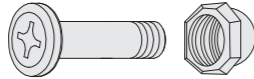
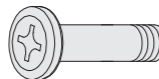
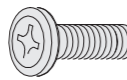

# COMPONENT LIST

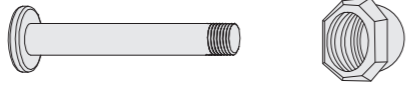
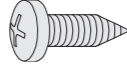
PARTS #	QTY	DESCRIPTION
Q	104	
NN	4	Mosquito Mesh
CC	4	Privacy Curtain
ZS1	2	
ZS2	2	

WE HAVE PREPARED EXTRA SCREWS FOR YOU IN CASE OF LOSS OR DAMAGE.

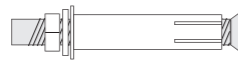
PARTS #	QTY	DESCRIPTION
S	12	 M6 X 47mm
T	64	 M6 X 24mm
U	4	 M6 X 24mm
V	229	 M6 X 15mm
V1	40	 M5 X 15mm
X	16	 M6 X 12 (D10 X 20)
X1	8	 M6 X 42mm
Y	24	 ST3.8 X 12mm
W2	1	
Z	1	
GG	1	
DD	8	
PZ	8	

• BASE FRAME INSTALLATION

STEP 01-09 ..... 12-20

• TOP FRAME INSTALLATION

STEP 10-12 ..... 21-23

• TOP PLATE INSTALLATION

STEP 13-20 ..... 24-31

• ACCESSORY INSTALLATION

STEP 21-23 ..... 32-34

 Two Times Required

 Four Times Required

 Step 14 and step 15 need to be operated at the same time.

 The dotted line represents the installation track.

# STEP

# 01

## BASE FRAME INSTALLATION

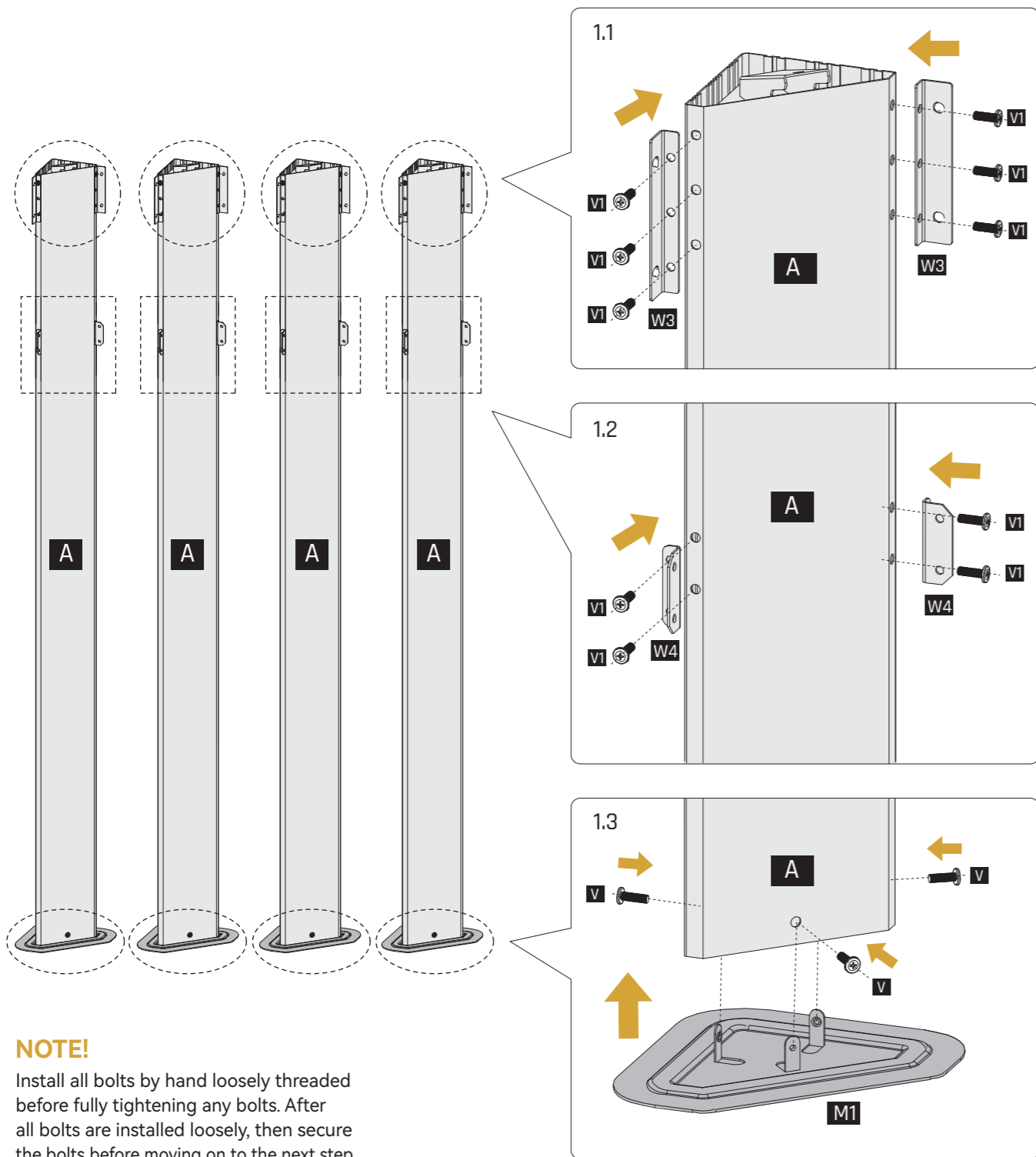
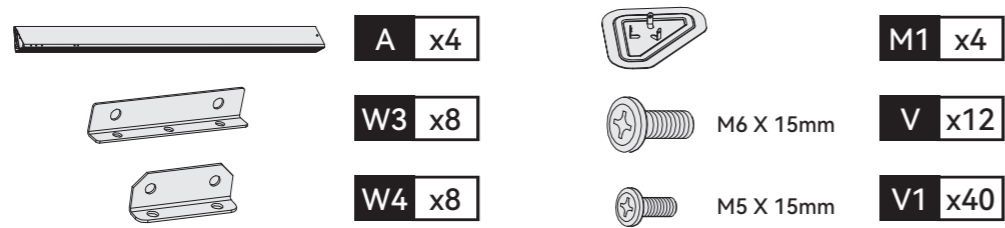

## BASE FRAME INSTALLATION

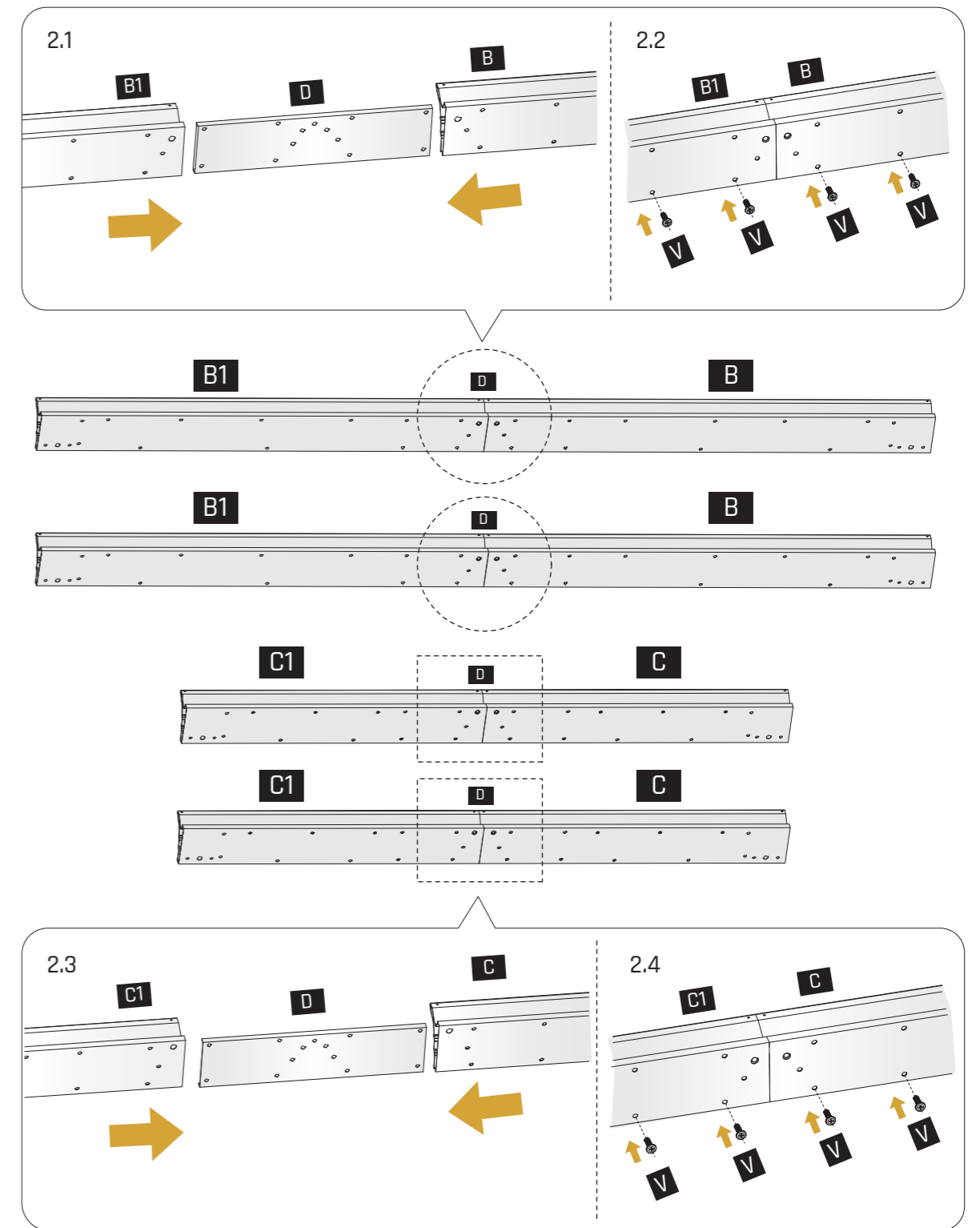
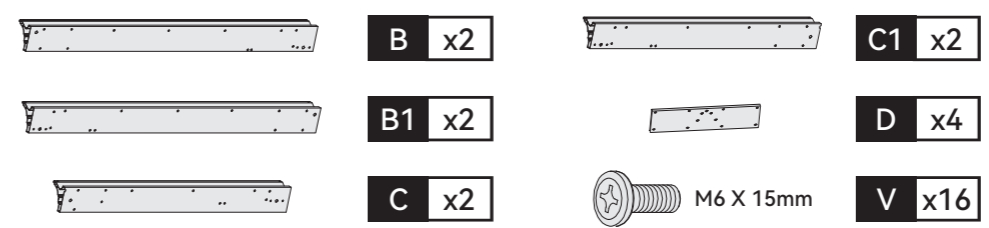

# STEP

# 02

STEP

03

BASE FRAME INSTALLATION

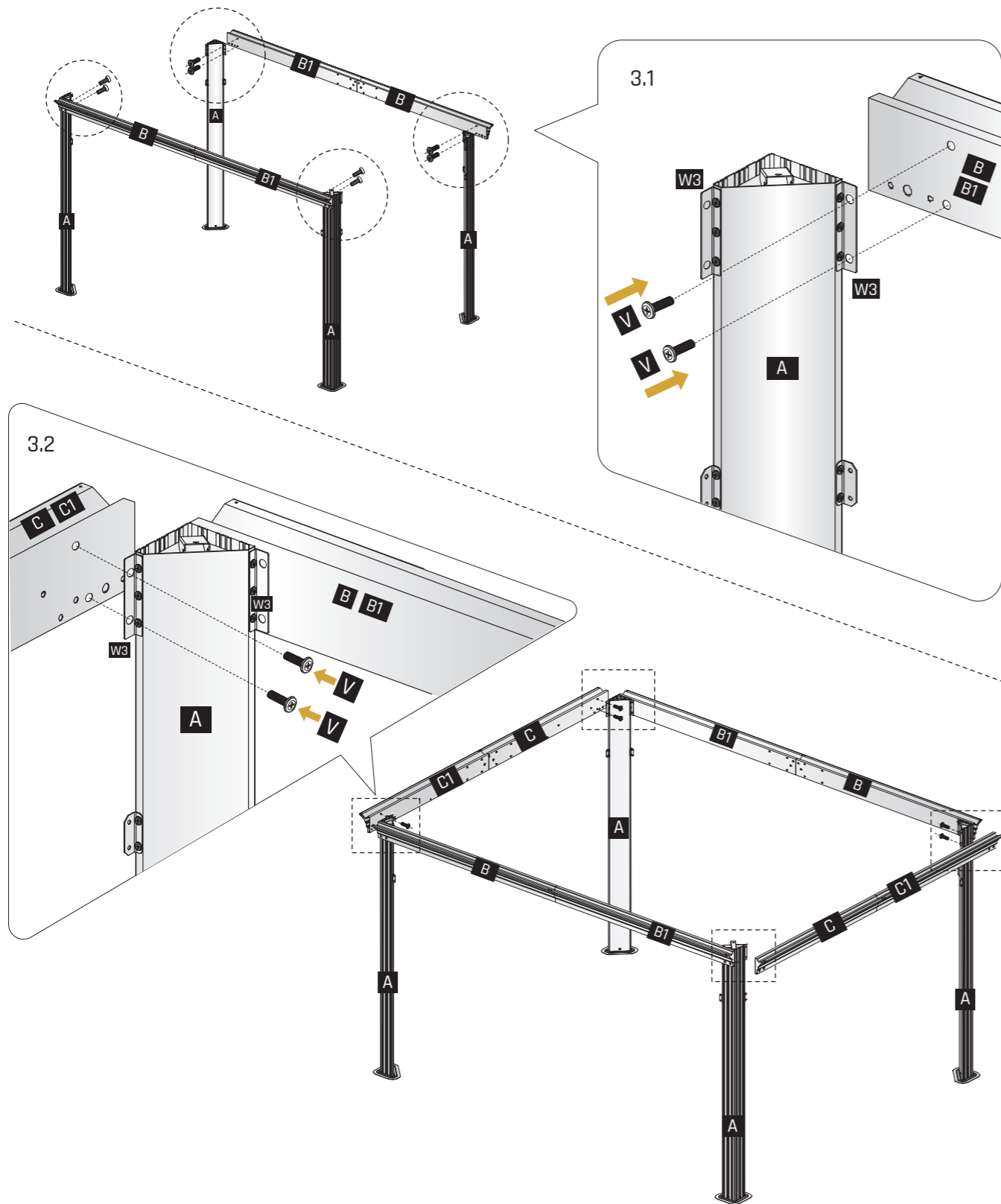
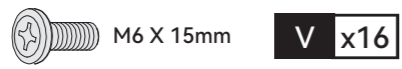

BASE FRAME INSTALLATION

STEP

04

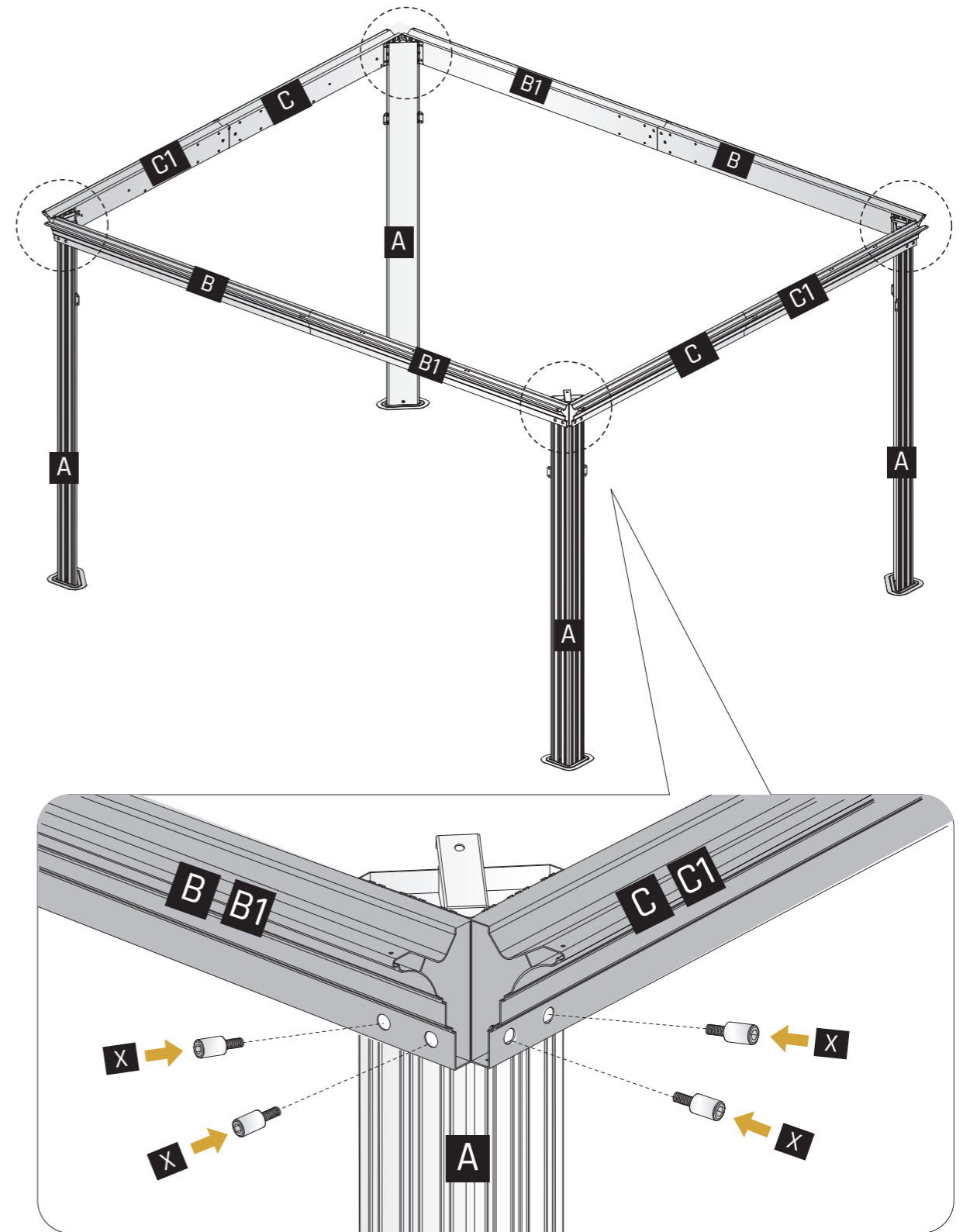

STEP

05

BASE FRAME INSTALLATION



W x4

W1 x4

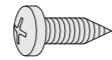

ST3.8 X 12mm

Y x24



M6 X 15mm

V x4

5.1

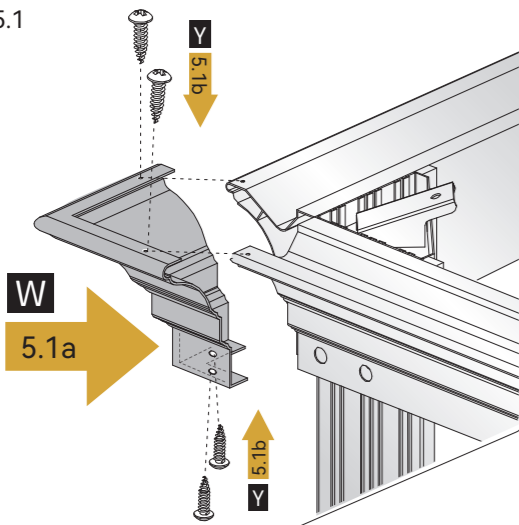

5.2

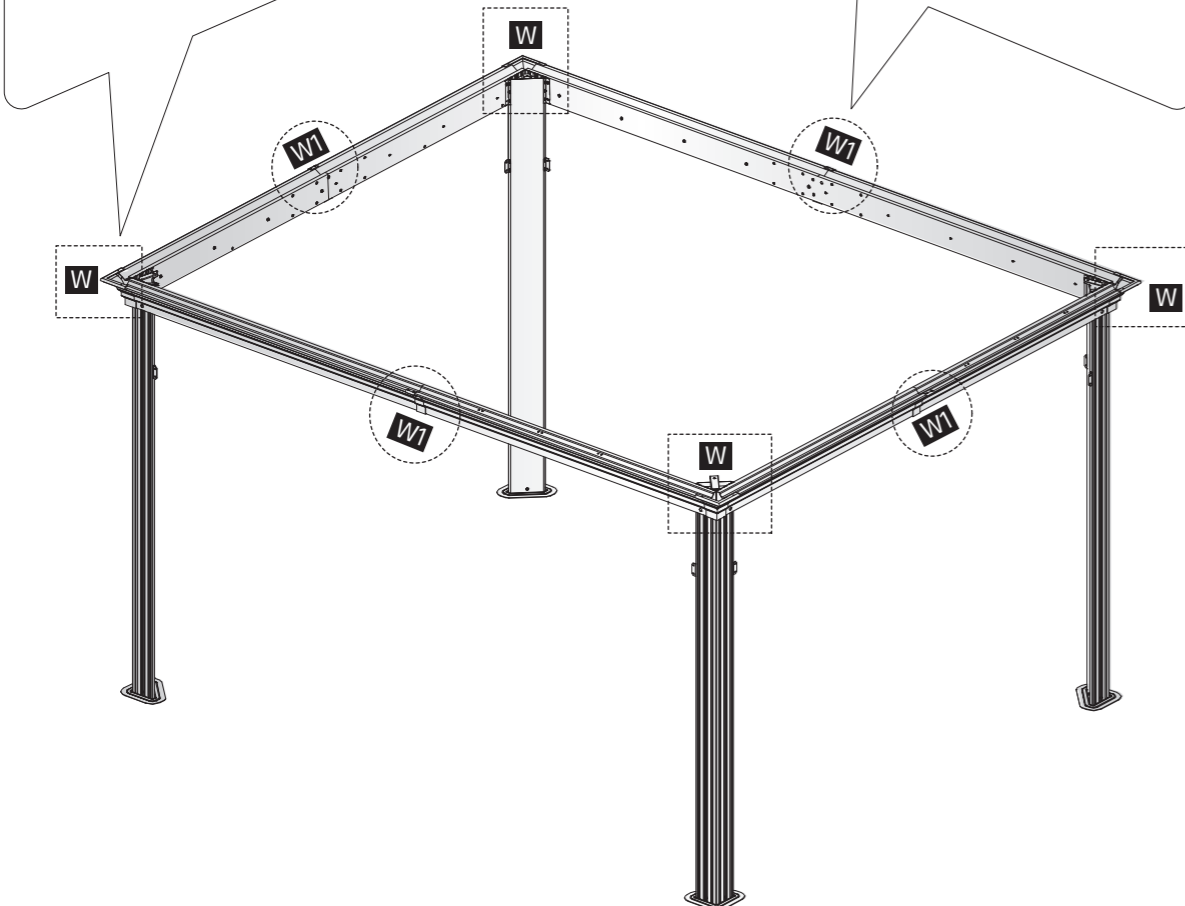
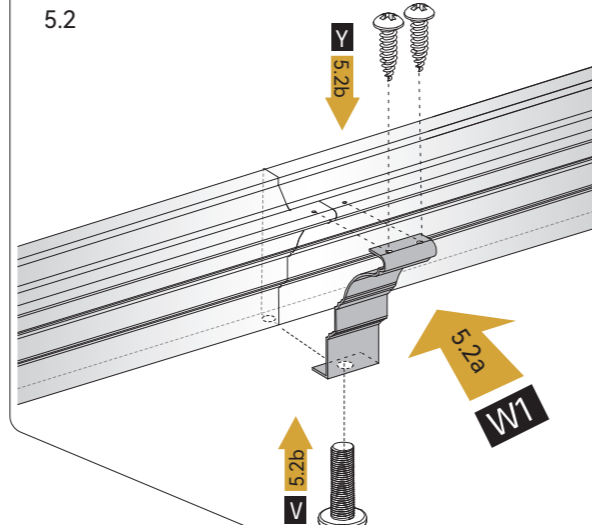

BASE FRAME INSTALLATION

STEP

06



L1 x4



M6 X 15mm

V x32

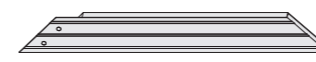

L2 x4

6.1

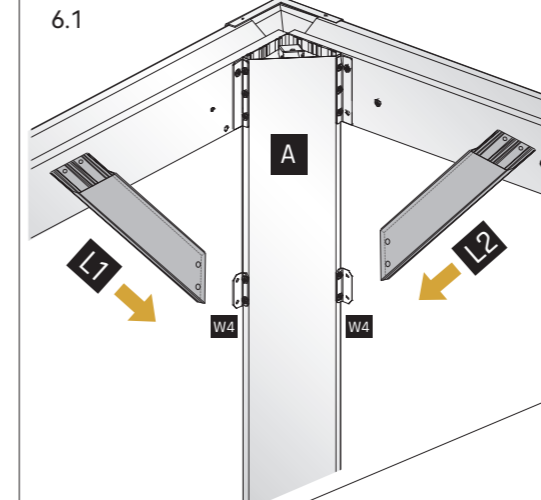

6.2

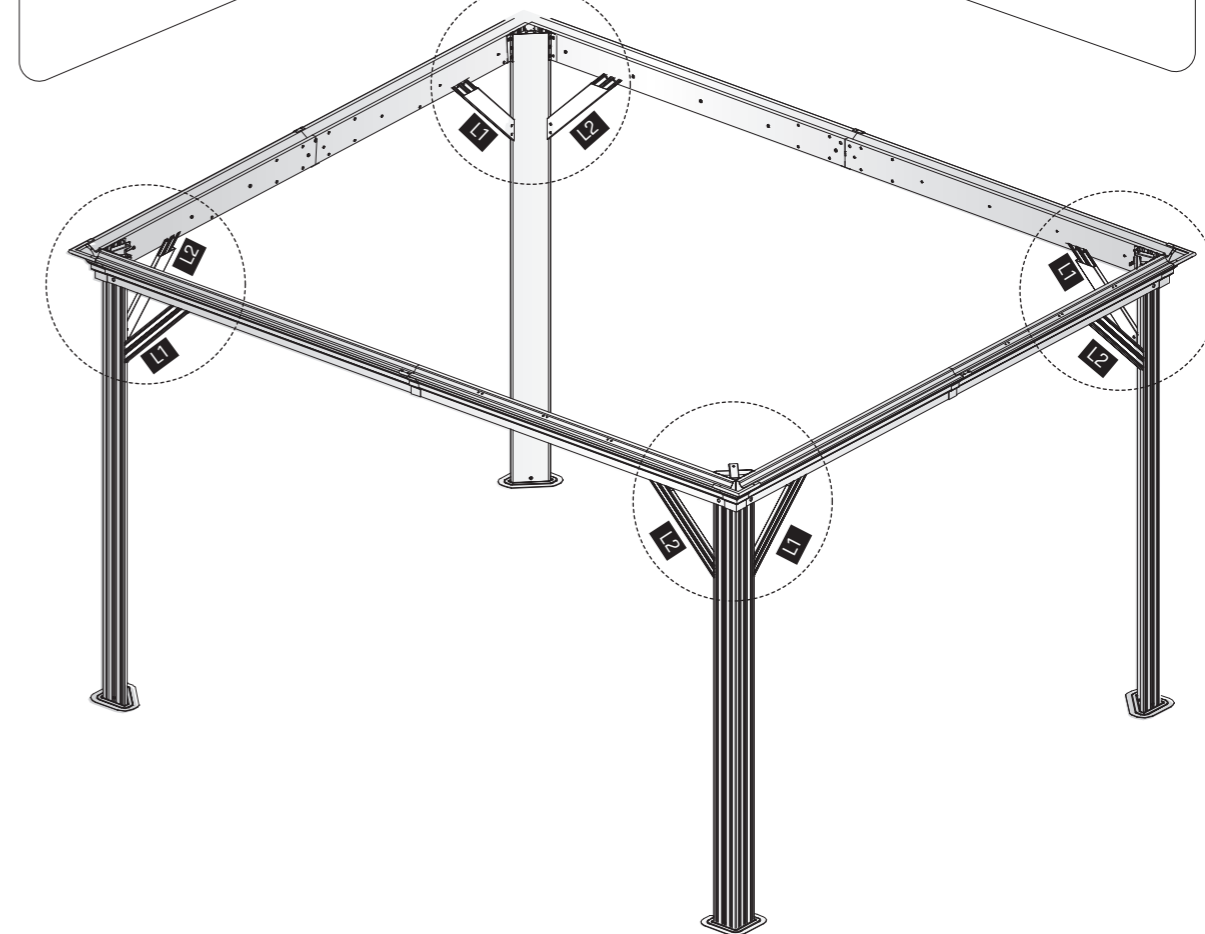
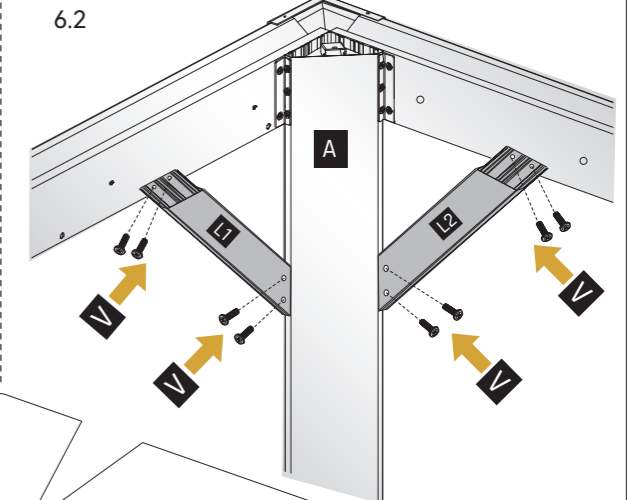

STEP

07

BASE FRAME INSTALLATION



C2 x4



B2 x4



Q x104

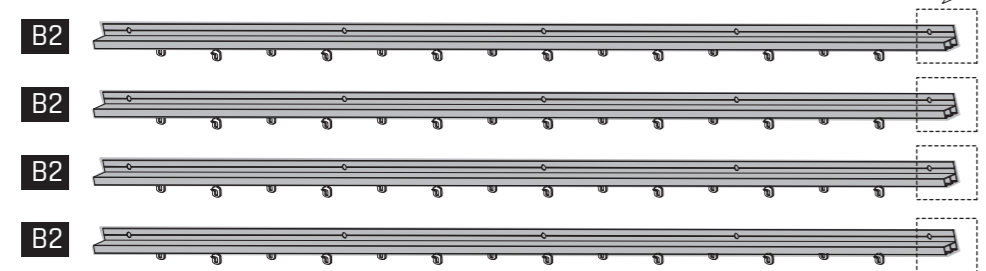
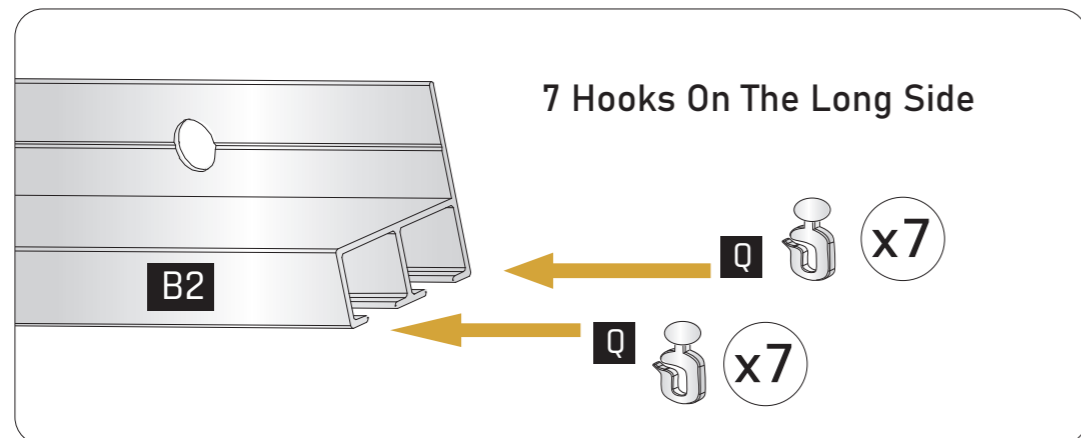
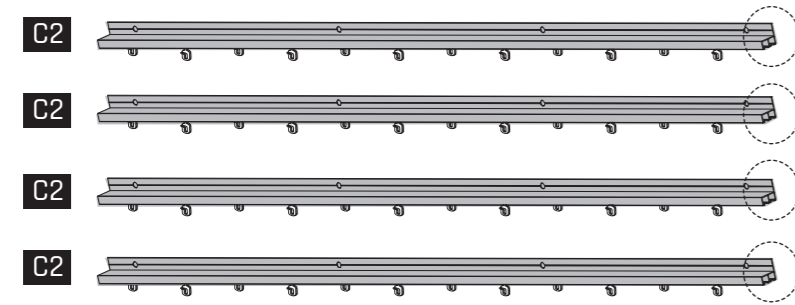
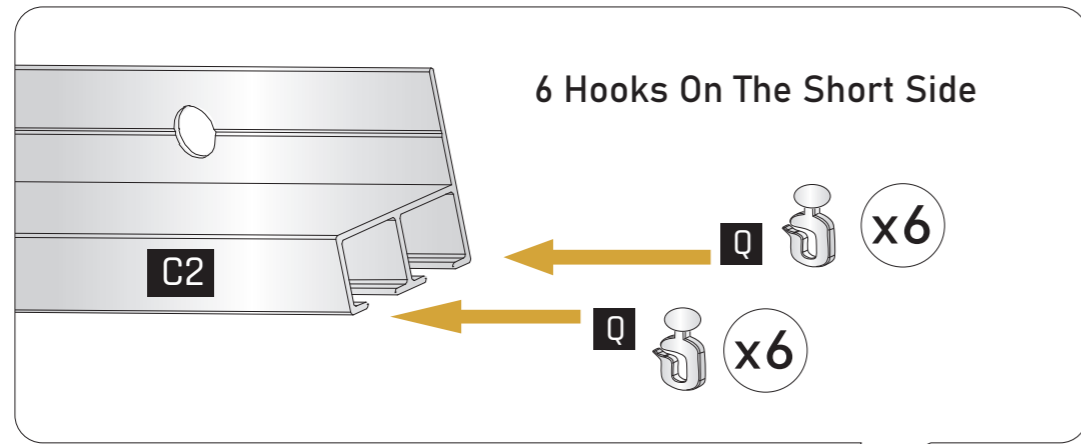

BASE FRAME INSTALLATION

STEP

08



Z1 x8



M6 X 15mm

V x36

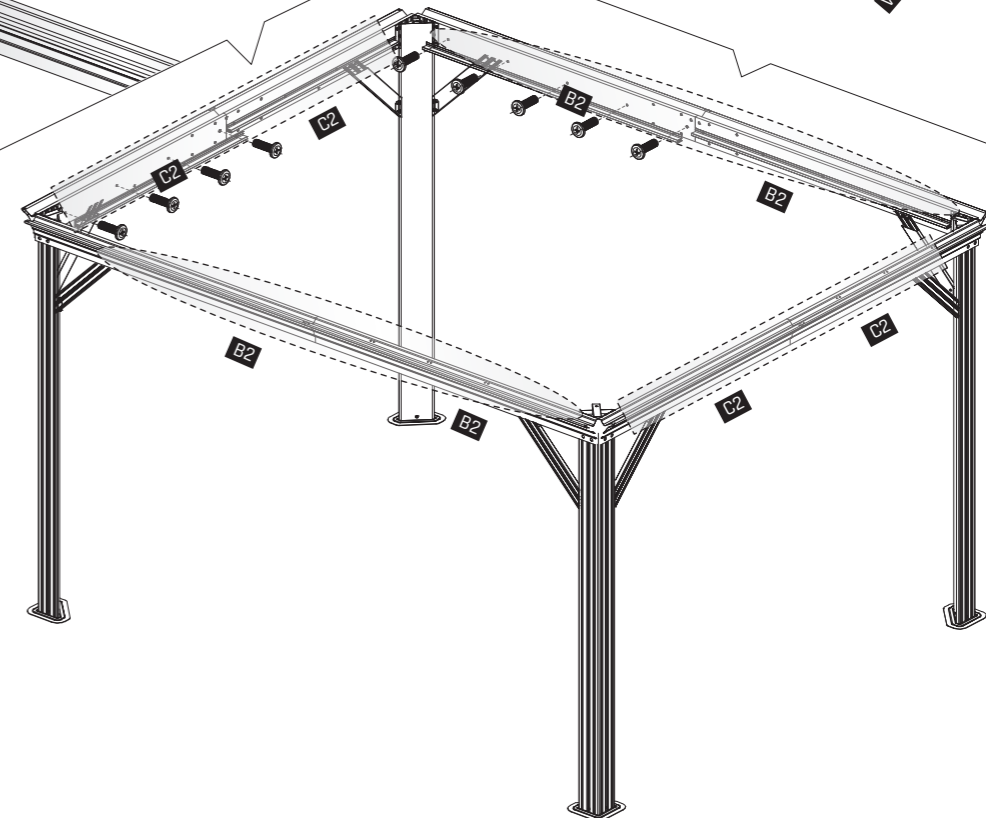
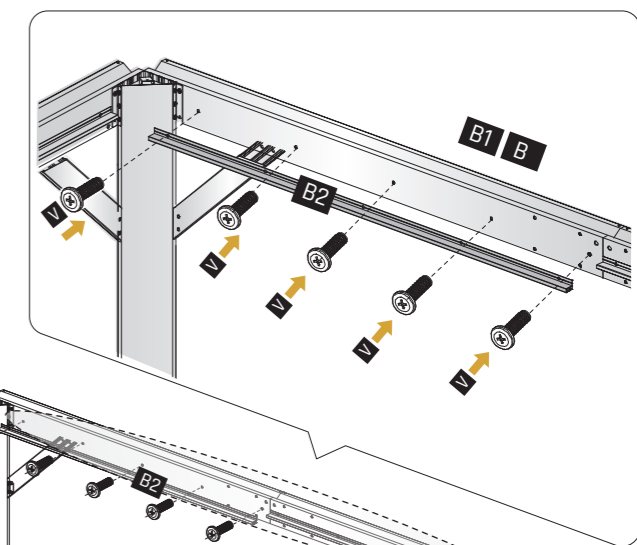
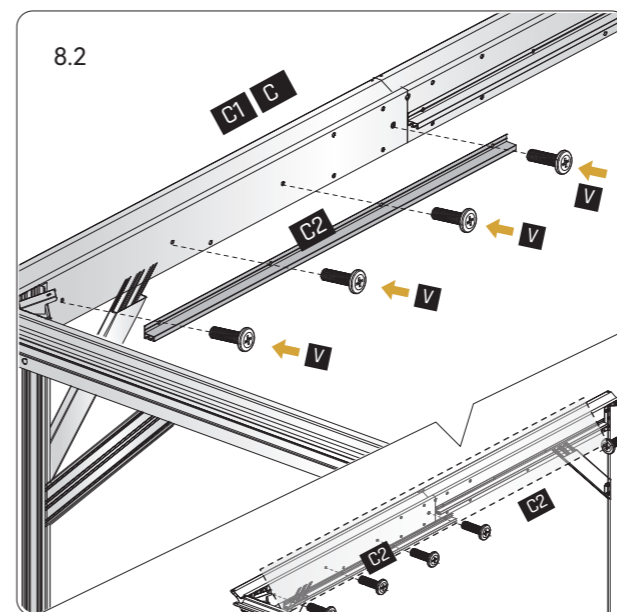
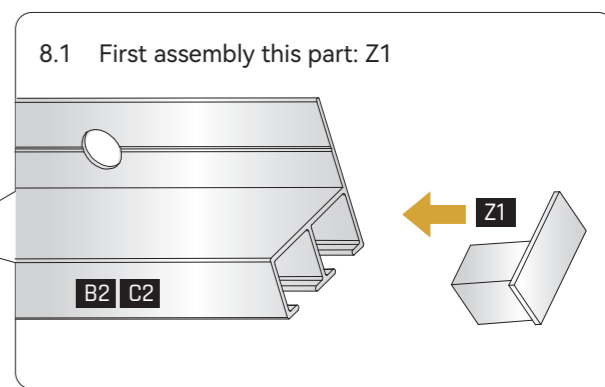
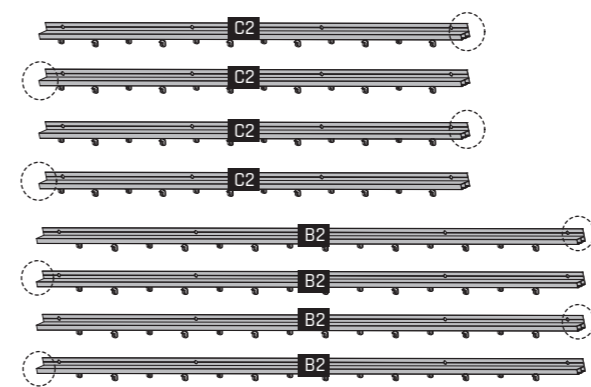

STEP

09

BASE FRAME INSTALLATION

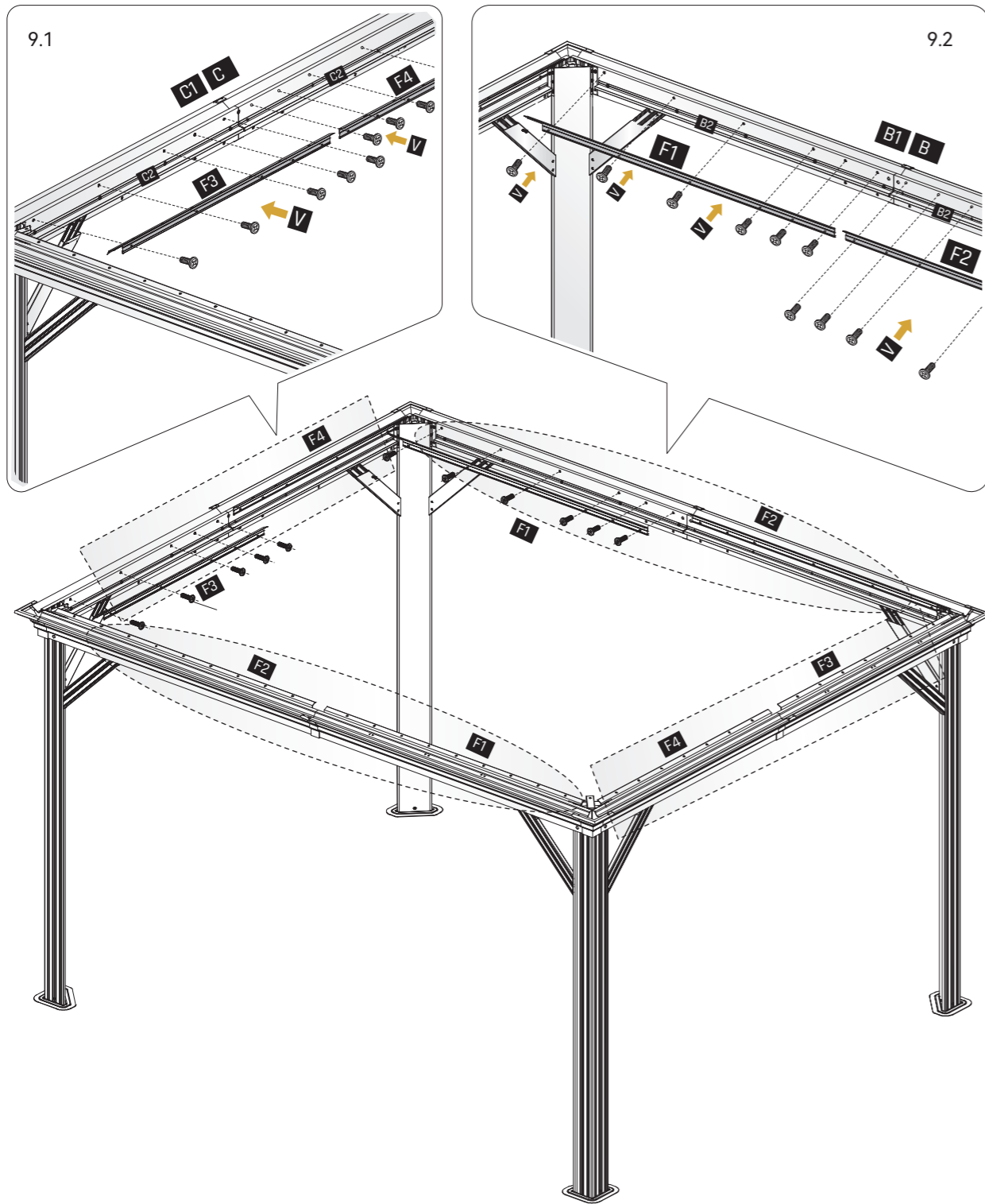
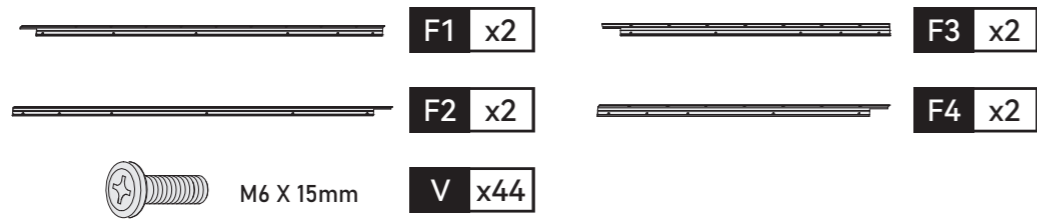

TOP FRAME INSTALLATION

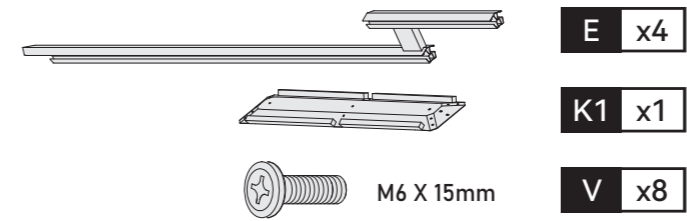

STEP

10

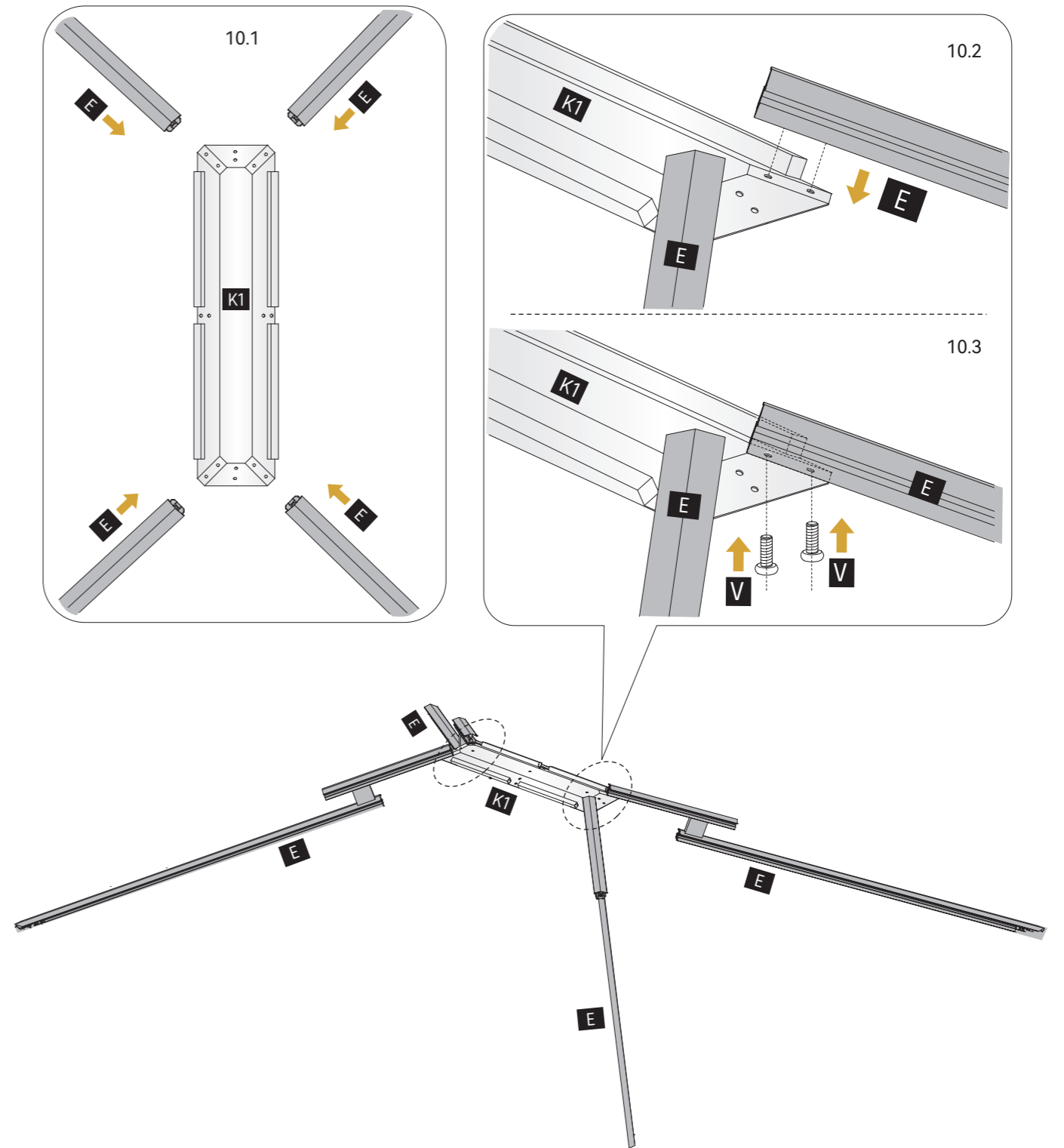

STEP

11

TOP FRAME INSTALLATION

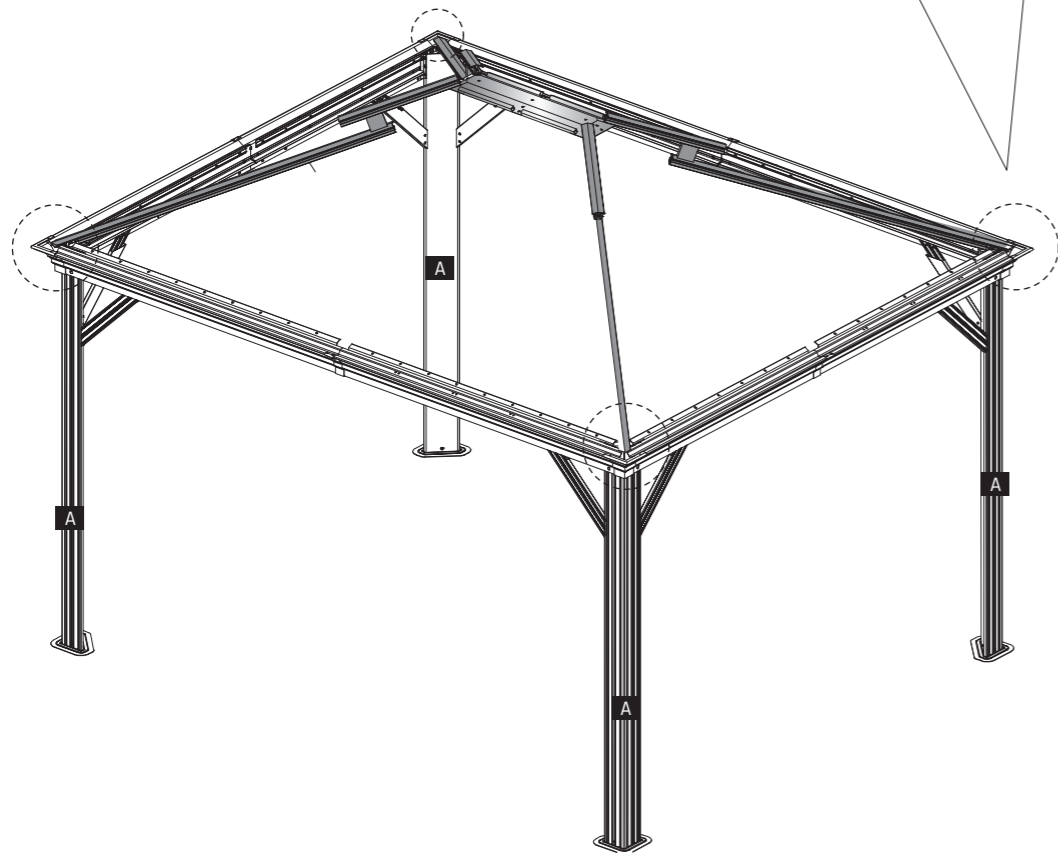
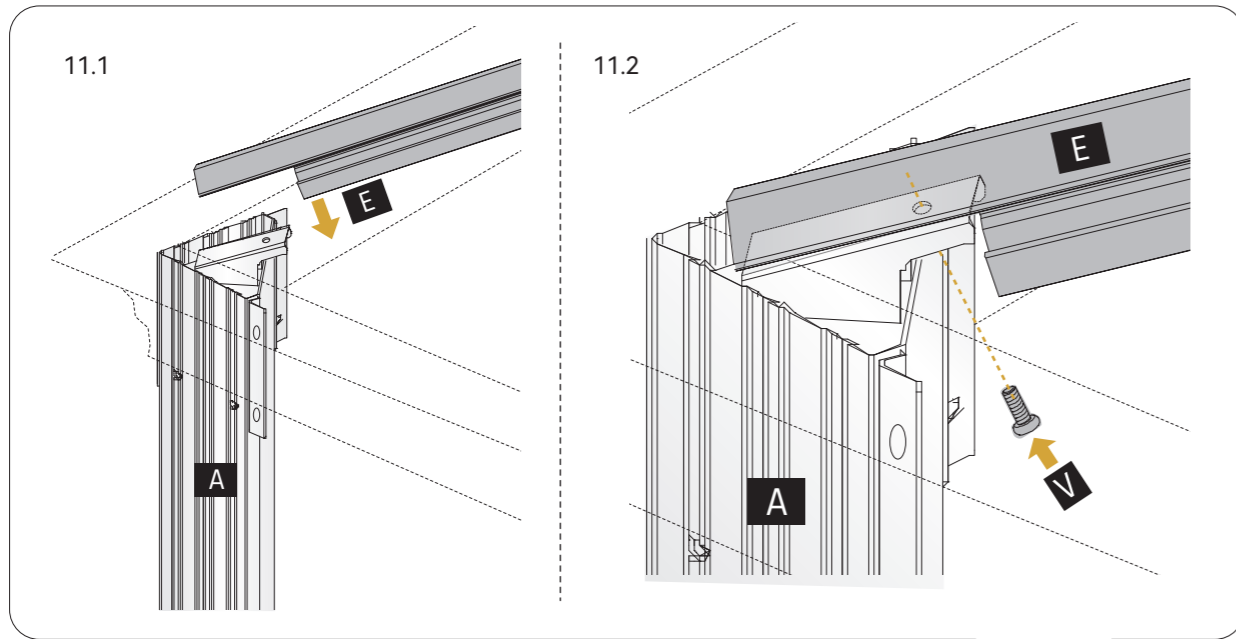

TOP FRAME INSTALLATION

STEP

12

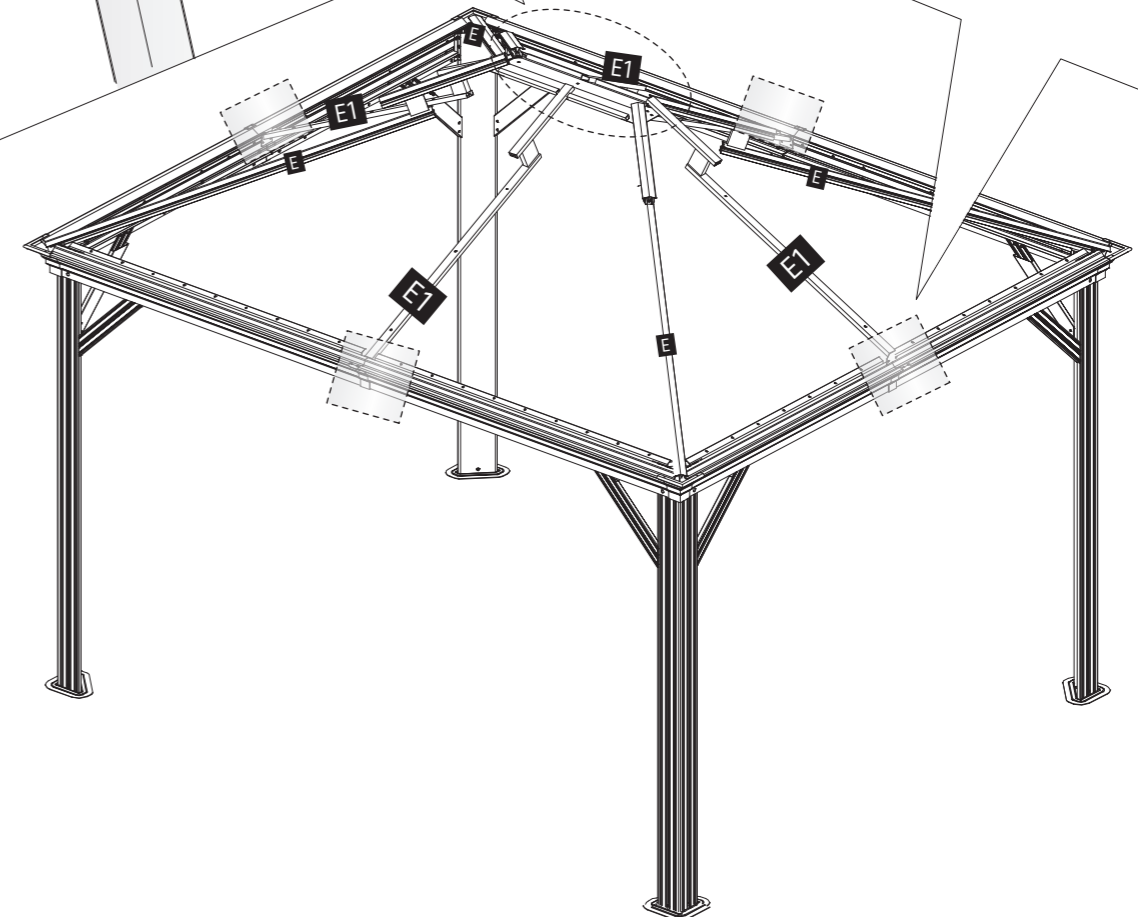
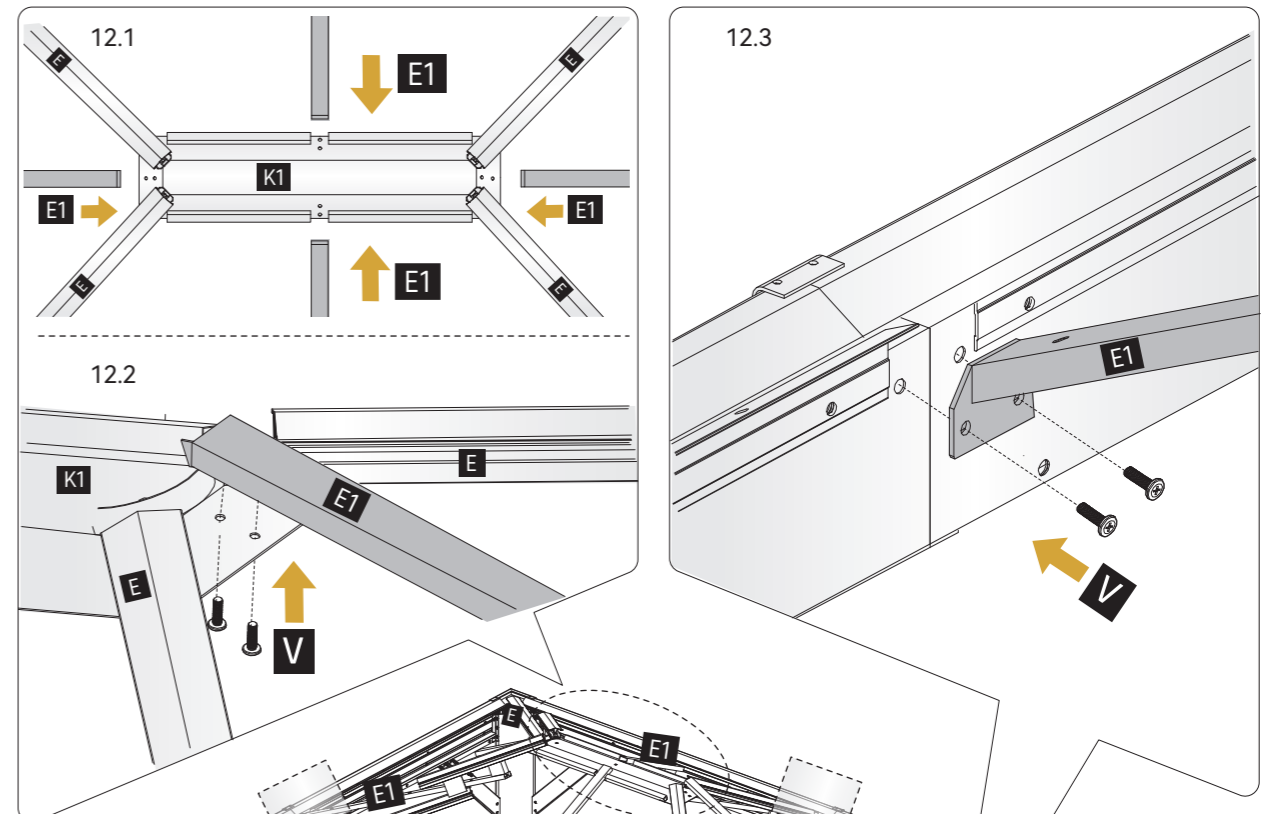

# STEP

# 13

## TOP PLATE INSTALLATION

R x56

D1 x16

GG x1

PLEASE WEAR GLOVES BEFORE INSTALLATION.

Please place the roof parts according to the position shown below before installation.

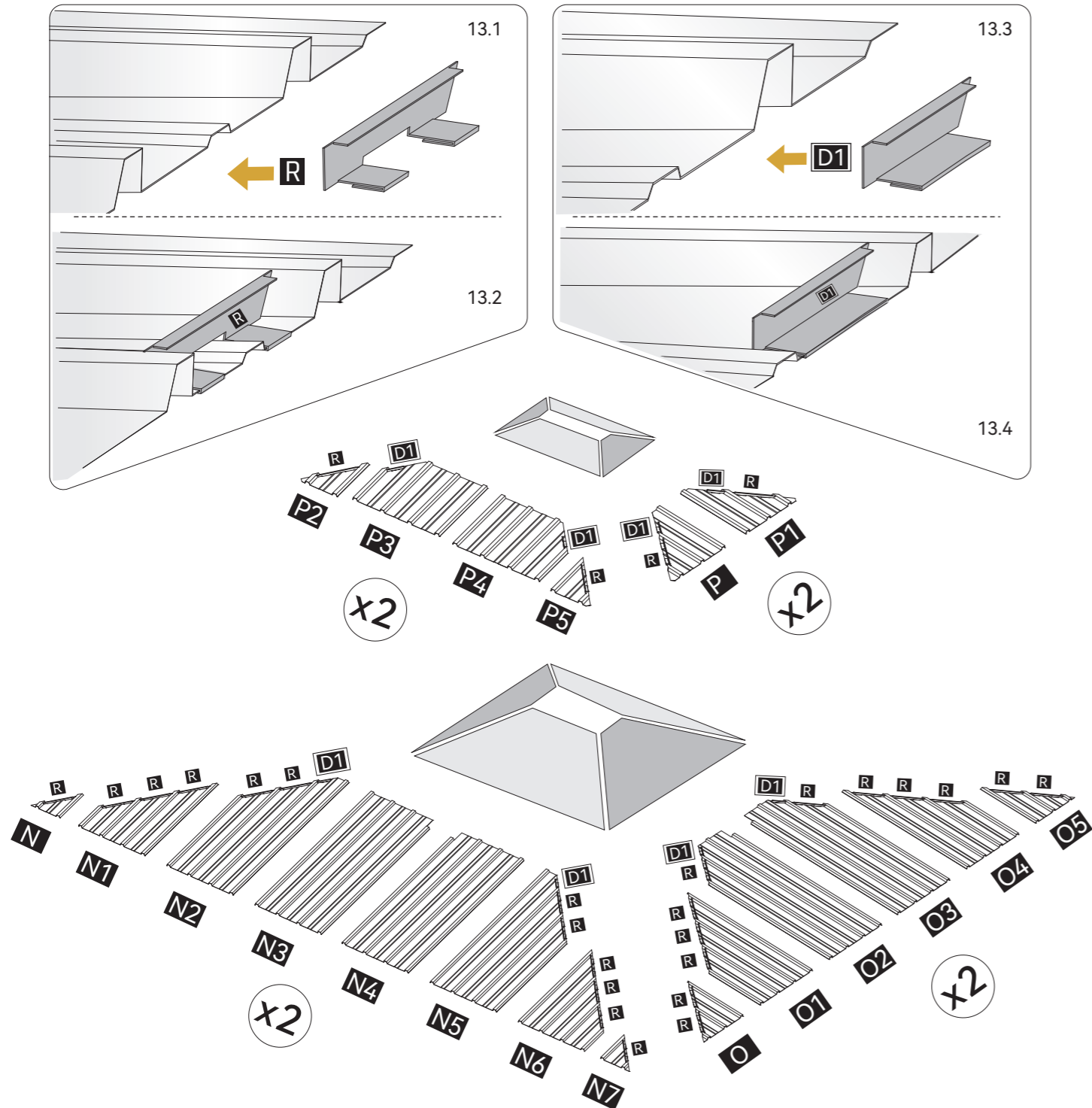

## TOP PLATE INSTALLATION

STEP 14 AND STEP 15 ARE NEED TO BE OPERATED AT THE SAME TIME.

# STEP

# 14

J x2

M6 X 15mm V x2

P2 x2

P3 x2

P4 x2

P5 x2

Assemble the bevel of P/P1/P2/P5 into E.

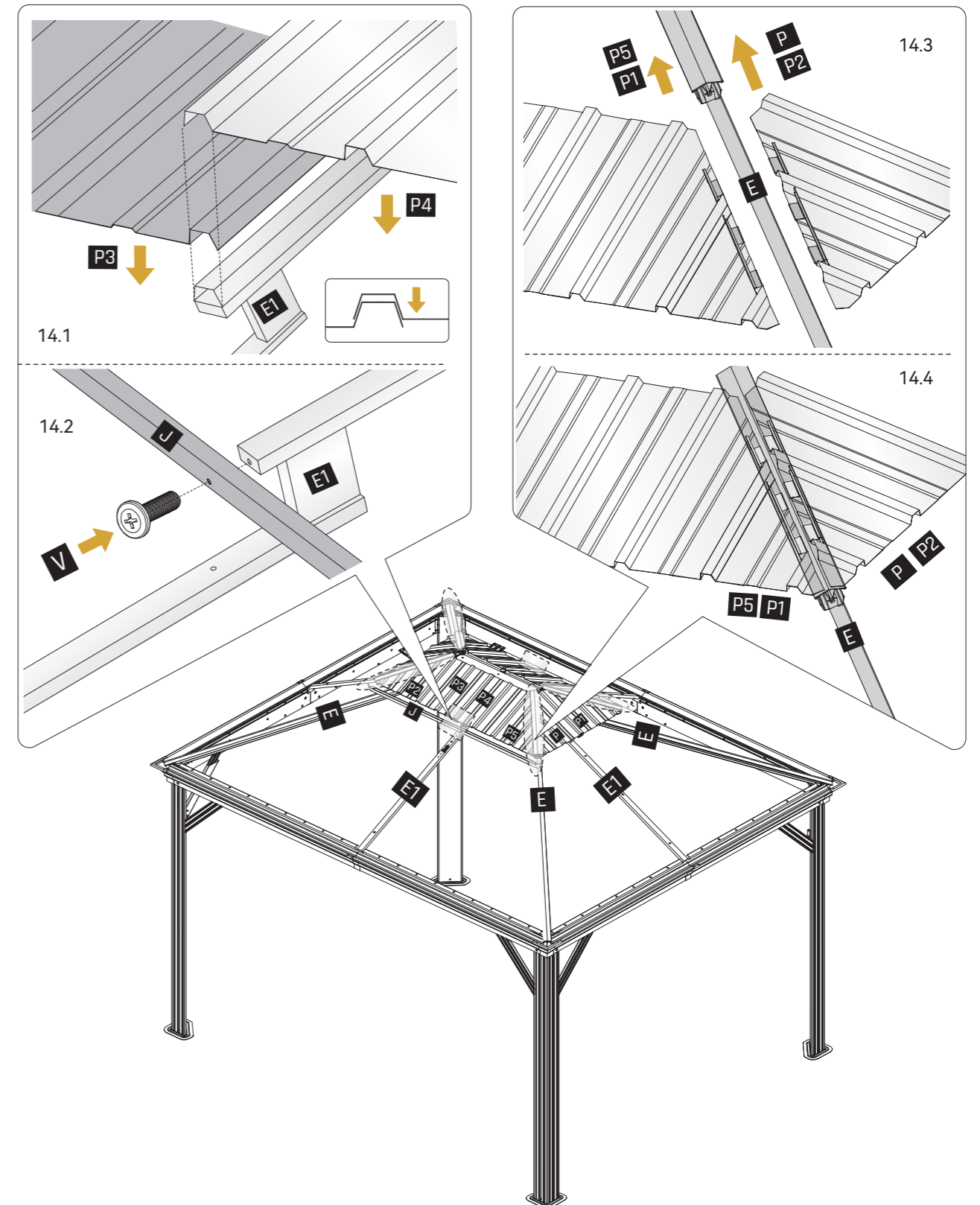

# STEP

# 15

## TOP PLATE INSTALLATION

STEP 14 AND STEP 15 ARE NEED TO BE OPERATED AT THE SAME TIME.

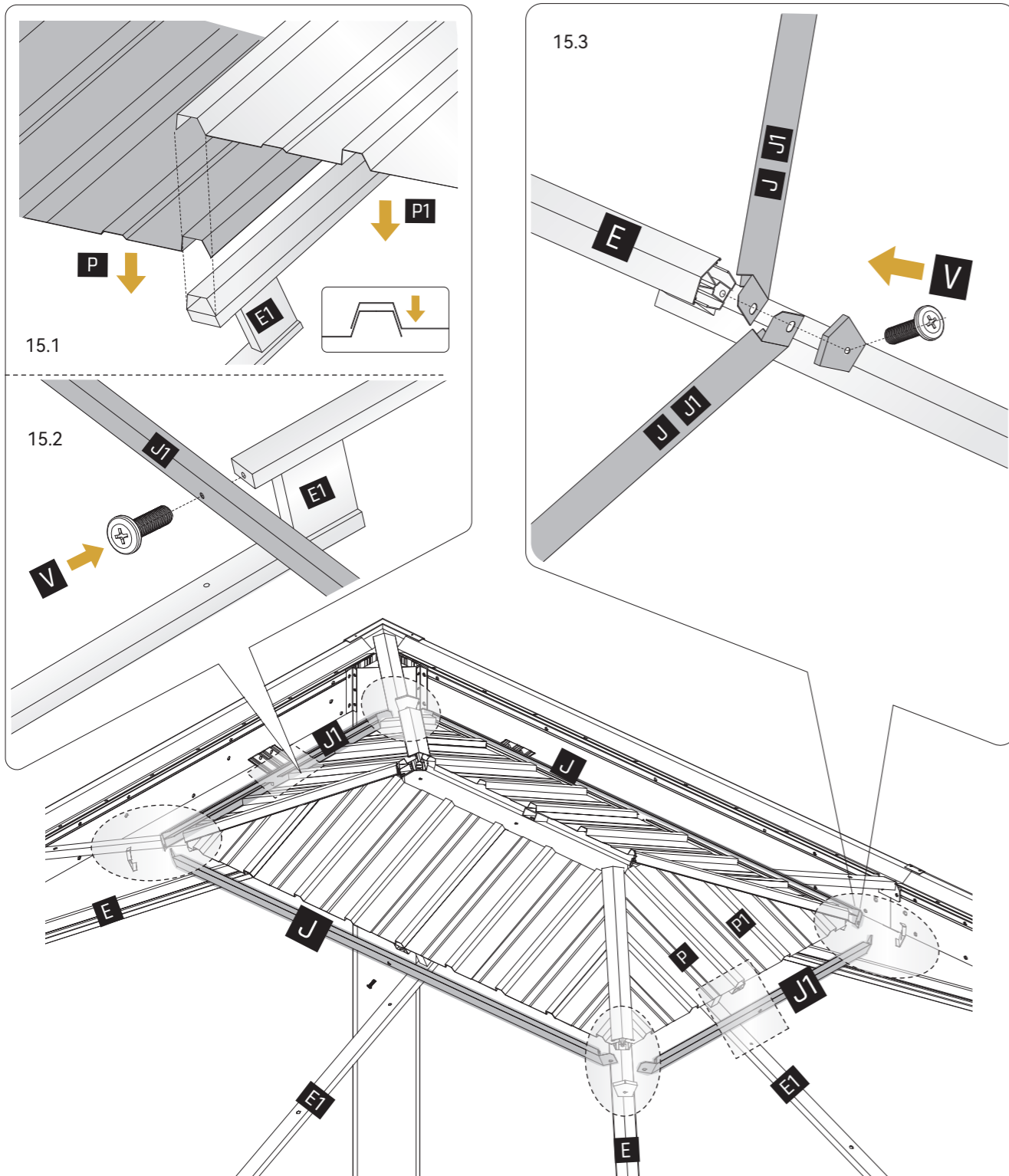
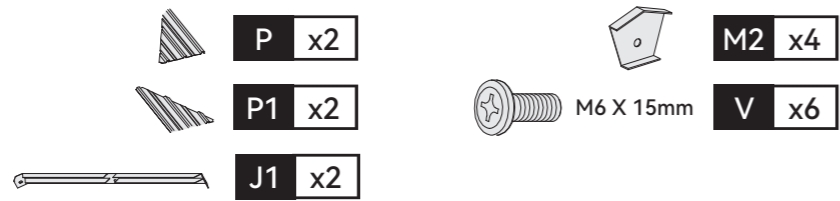

## TOP PLATE INSTALLATION

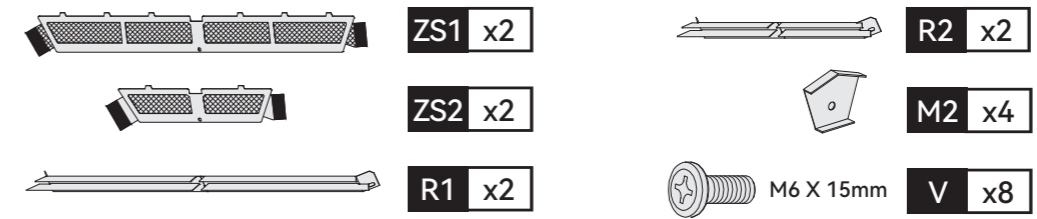

# STEP

# 16

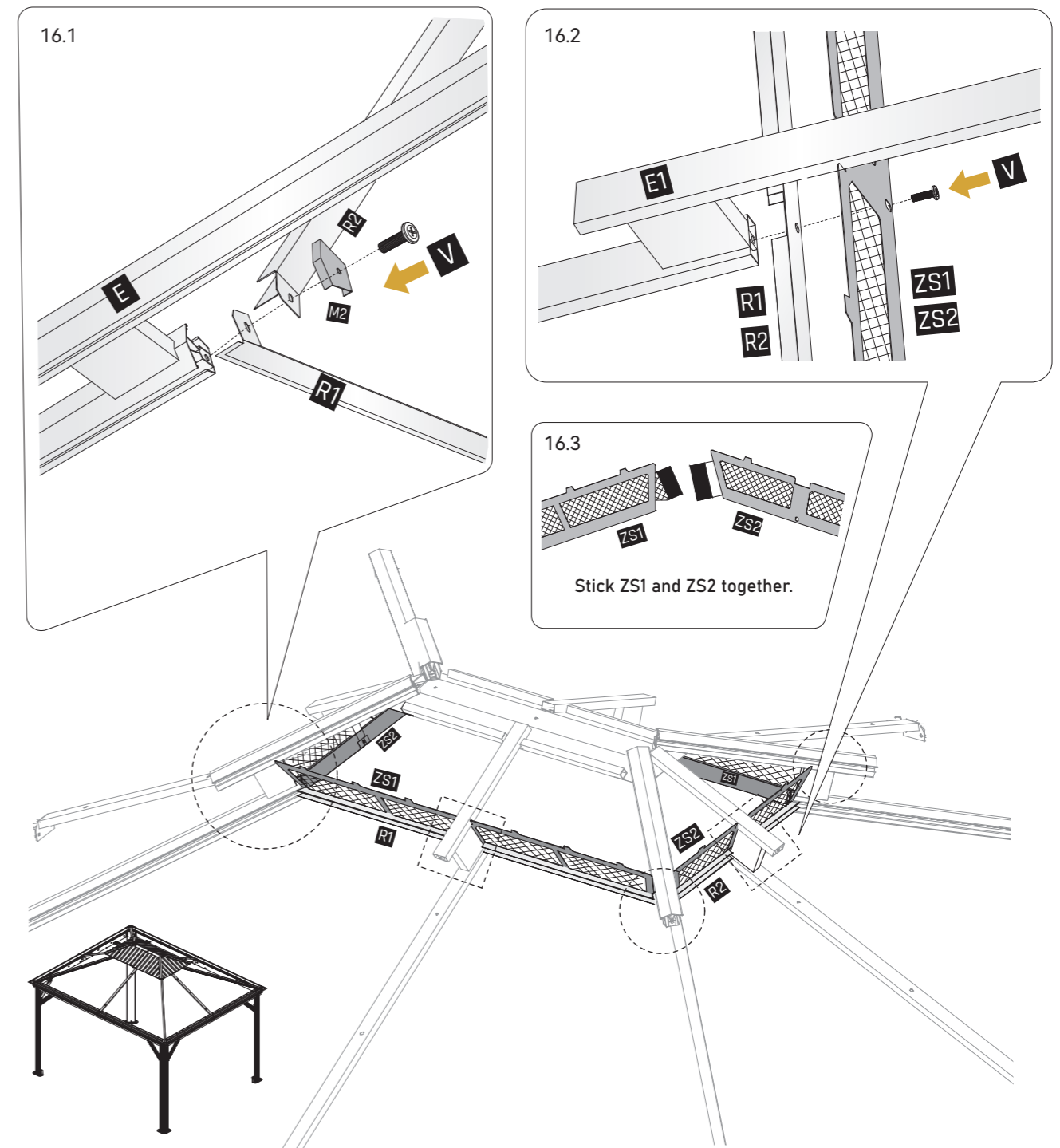

STEP

17

TOP PLATE INSTALLATION

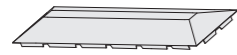

K x1



Wa x2



M6 X 15mm

V x1

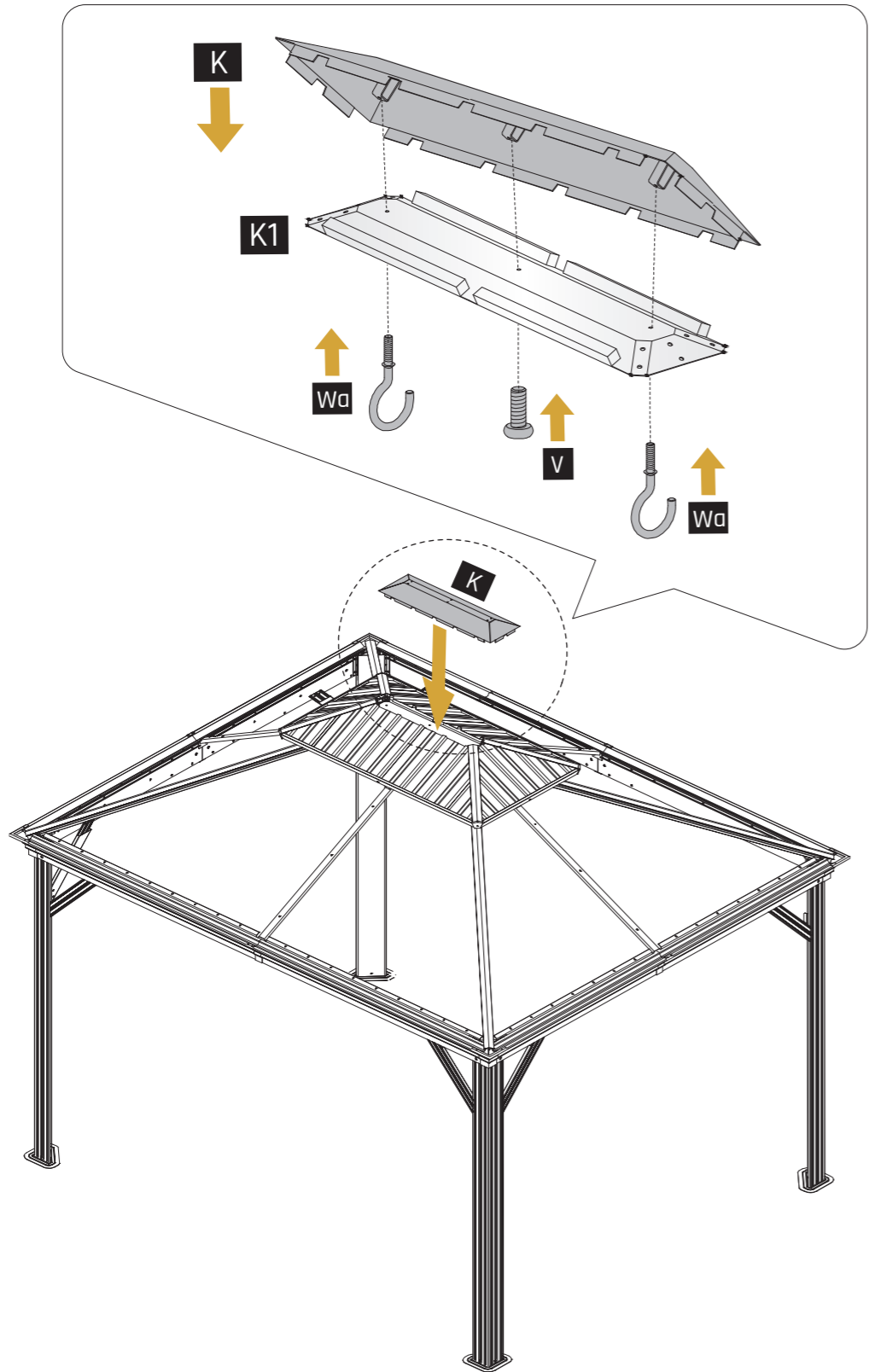

TOP PLATE INSTALLATION



H x4



I x4



M3 x4

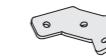

M4 x4

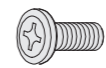

M6 X 15mm

V x24

STEP

18

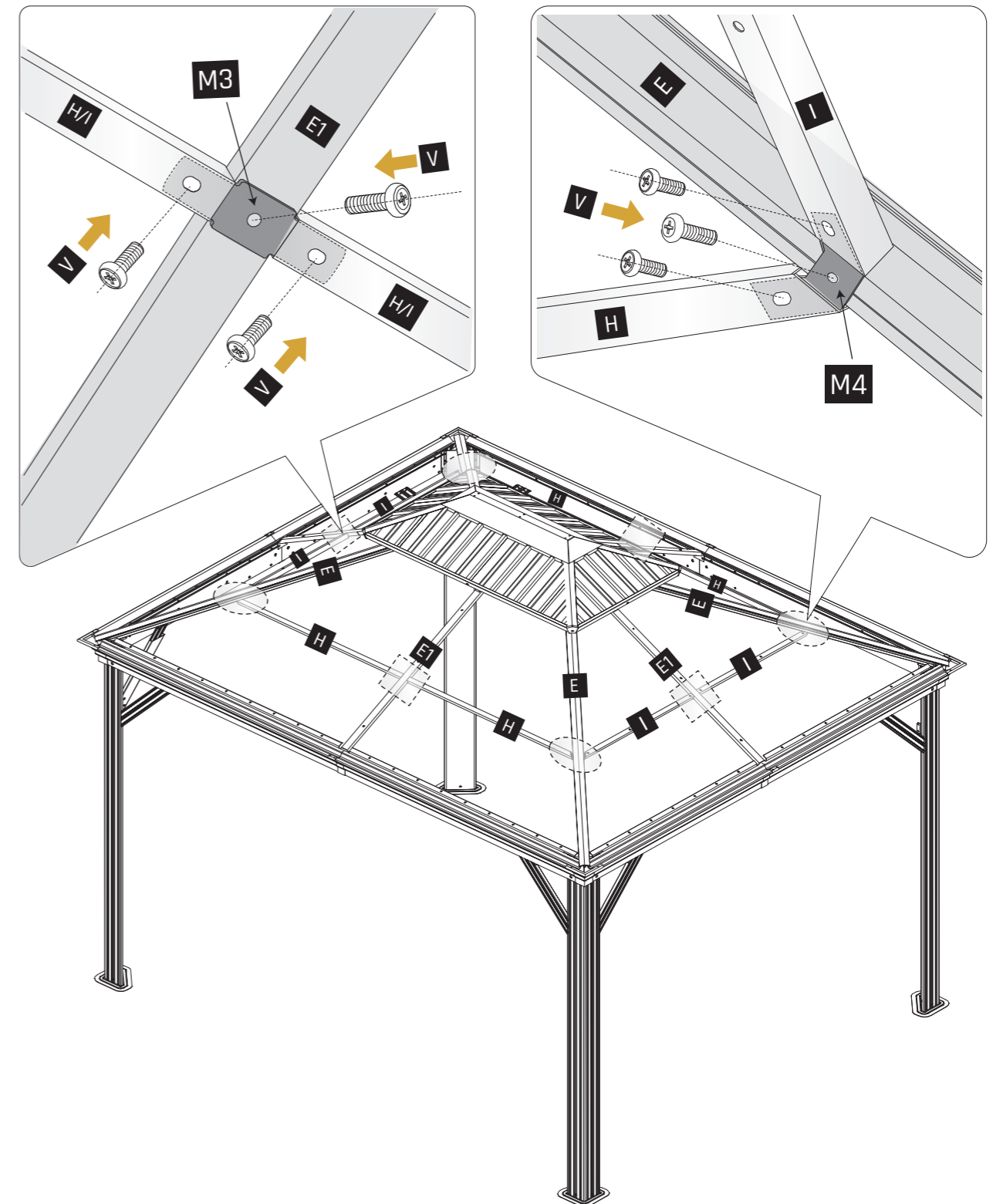

STEP

19

TOP PLATE INSTALLATION

- GG x1
- N2 x1
- N5 x1
- O x1
- O3 x1
- N x2
- N3 x2
- N6 x2
- O1 x2
- O4 x2
- N1 x2
- N4 x2
- N7 x2
- O2 x2
- O5 x2

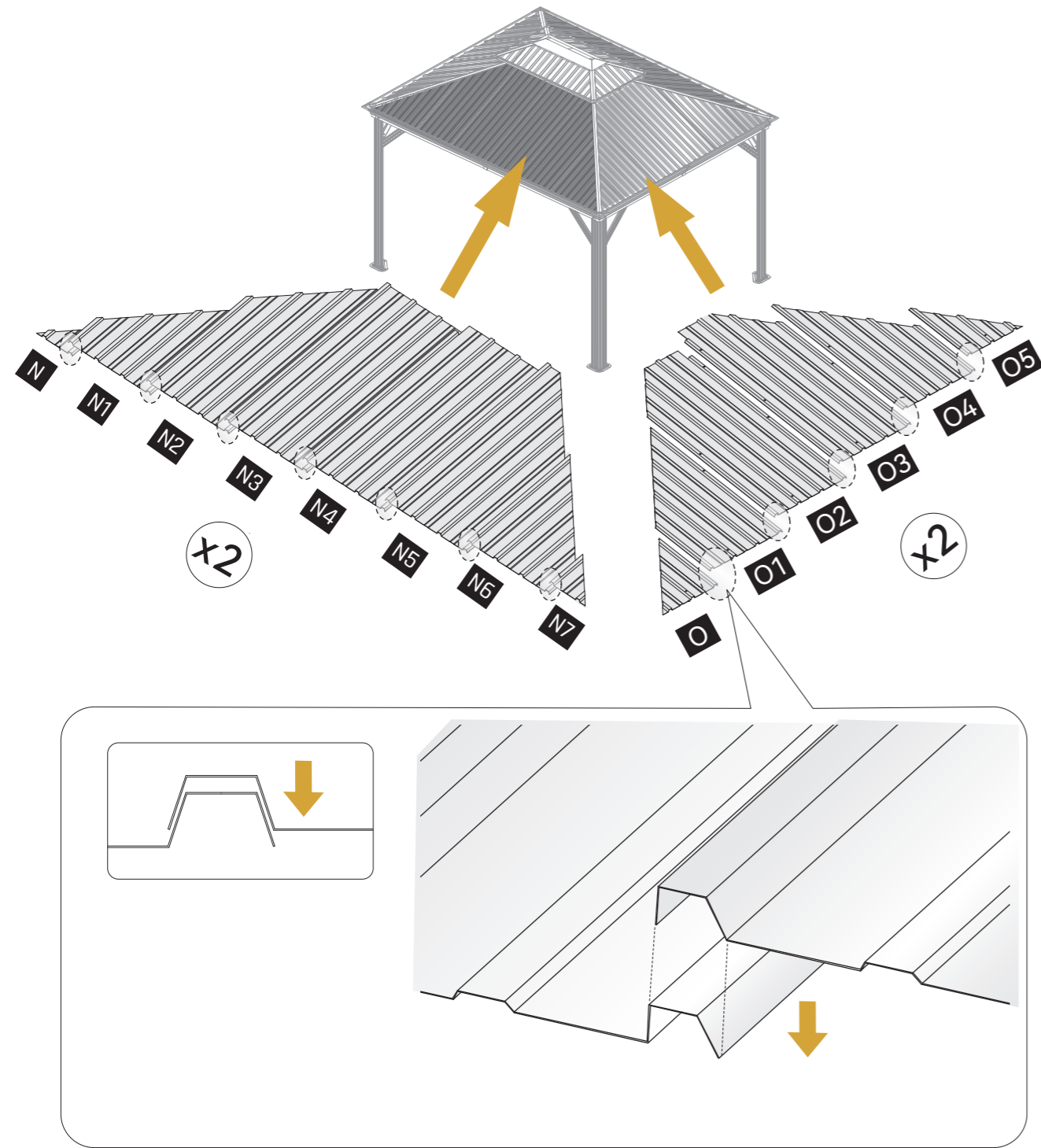

TOP PLATE INSTALLATION

STEP

20

- M6 X 42mm X1 x8
- M6 X 47mm S x12
- M6 X 24mm U x4
- M6 X 24mm T x64

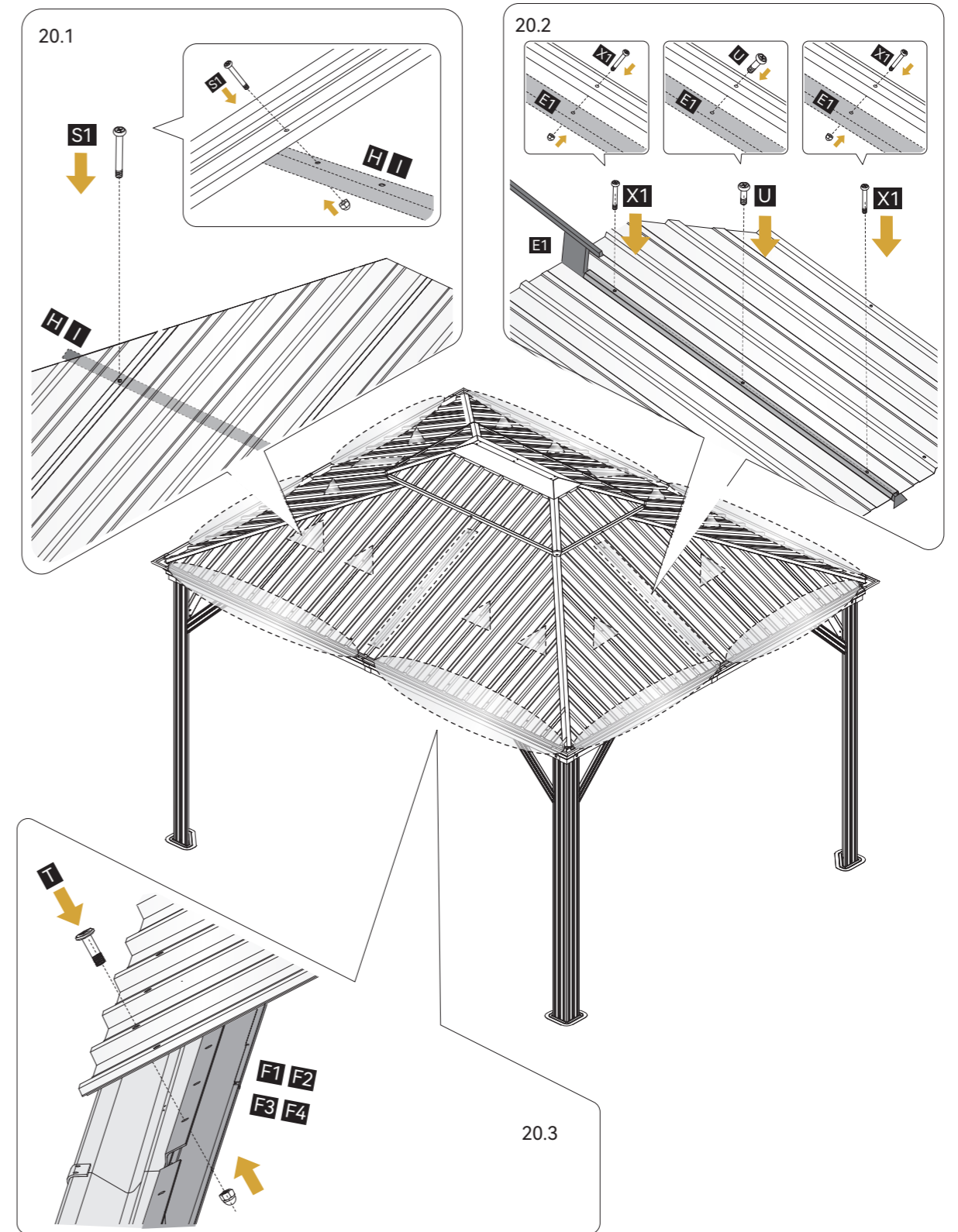

# STEP

# 21

## ACCESSORY INSTALLATION

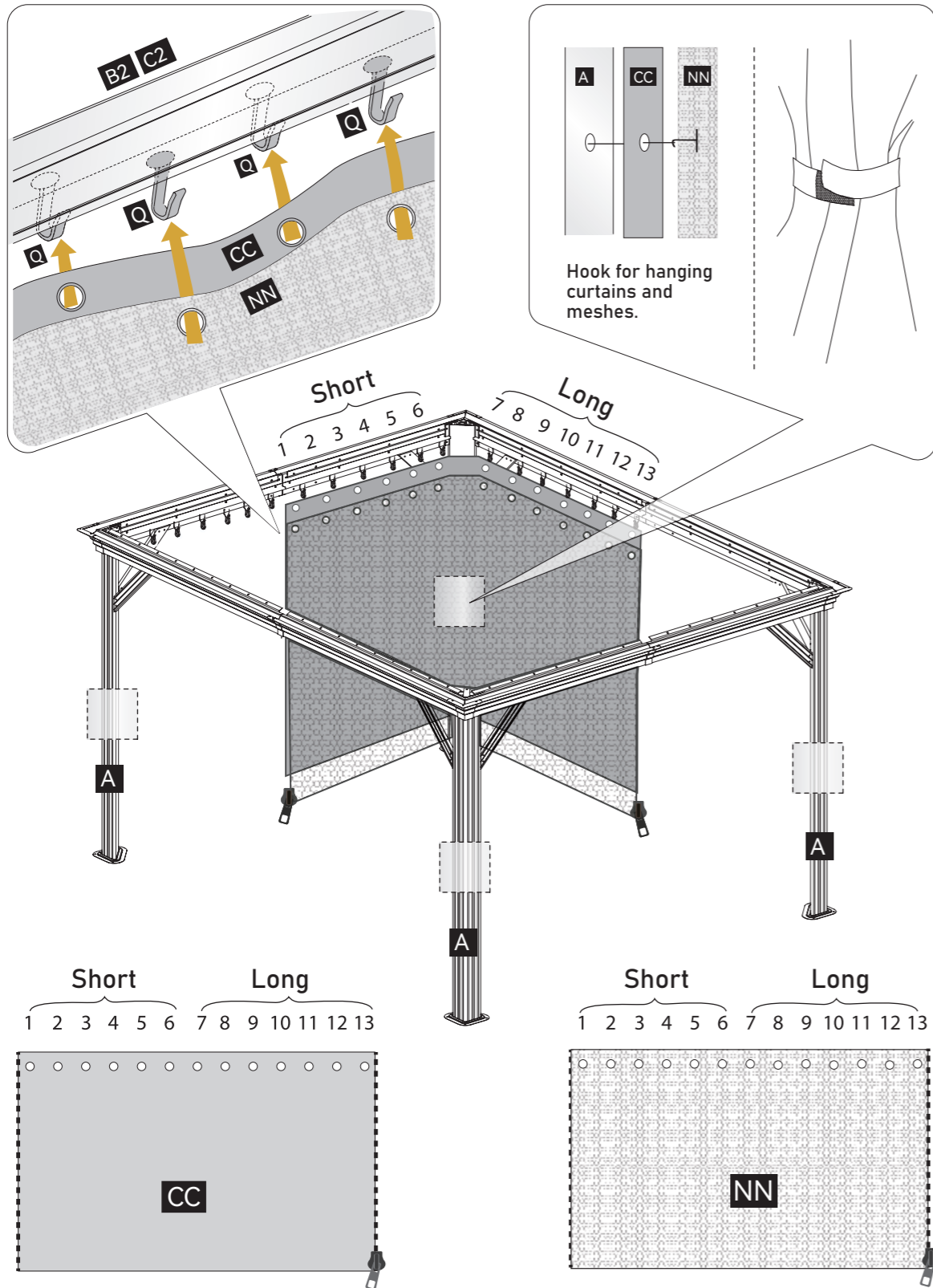
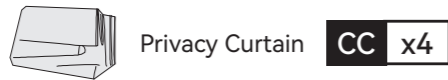
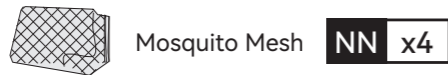

## ACCESSORY INSTALLATION

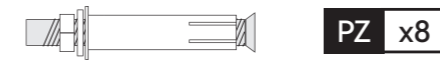

# STEP

# 22

## Install On Hard Floor

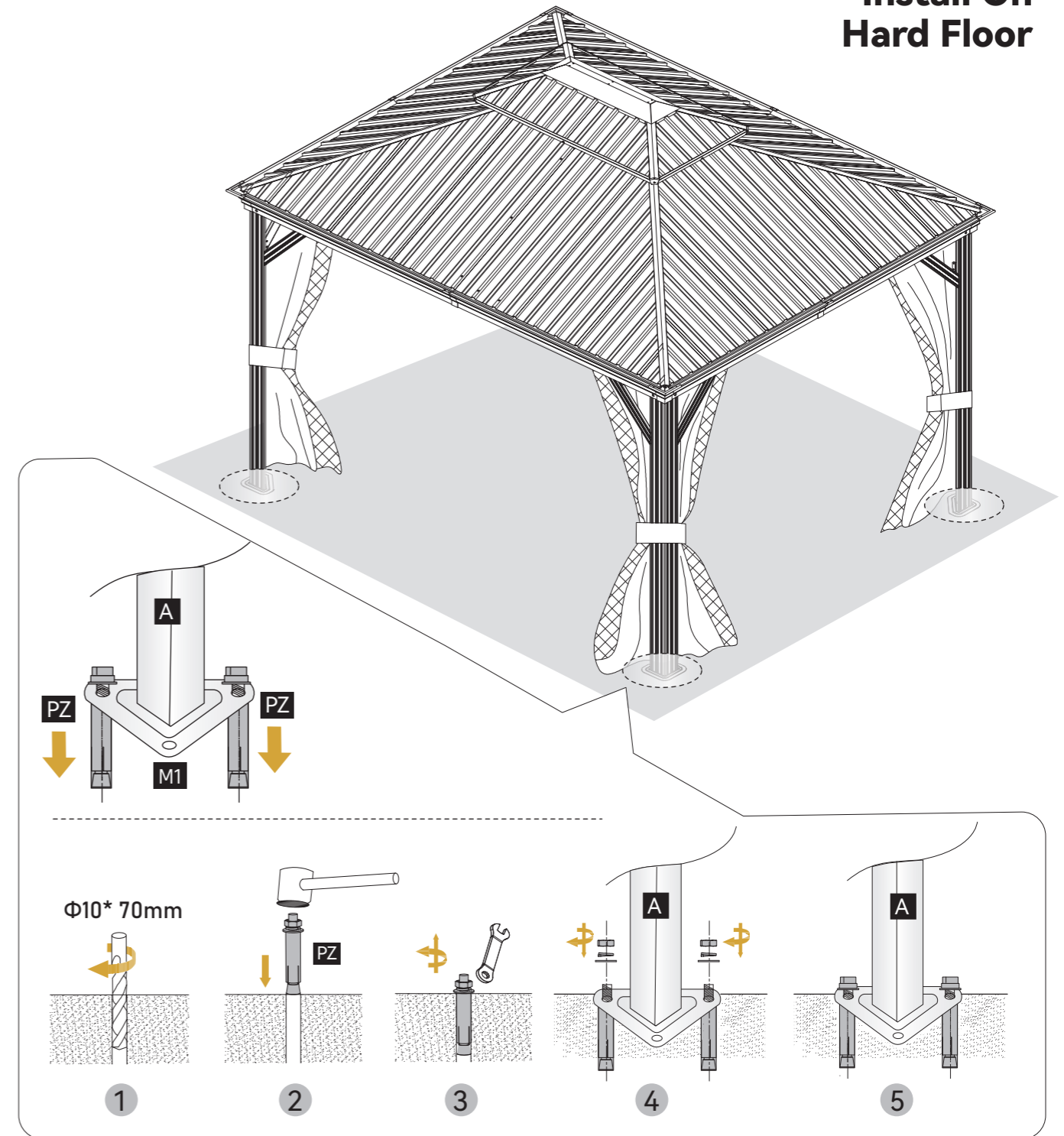

## ACCESSORY INSTALLATION

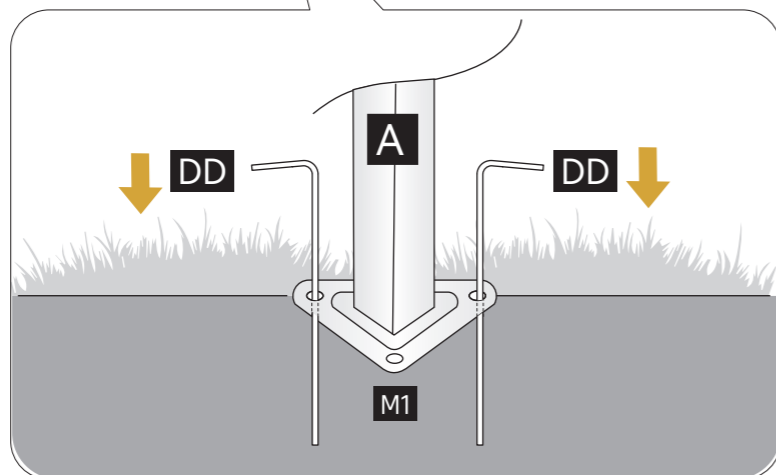
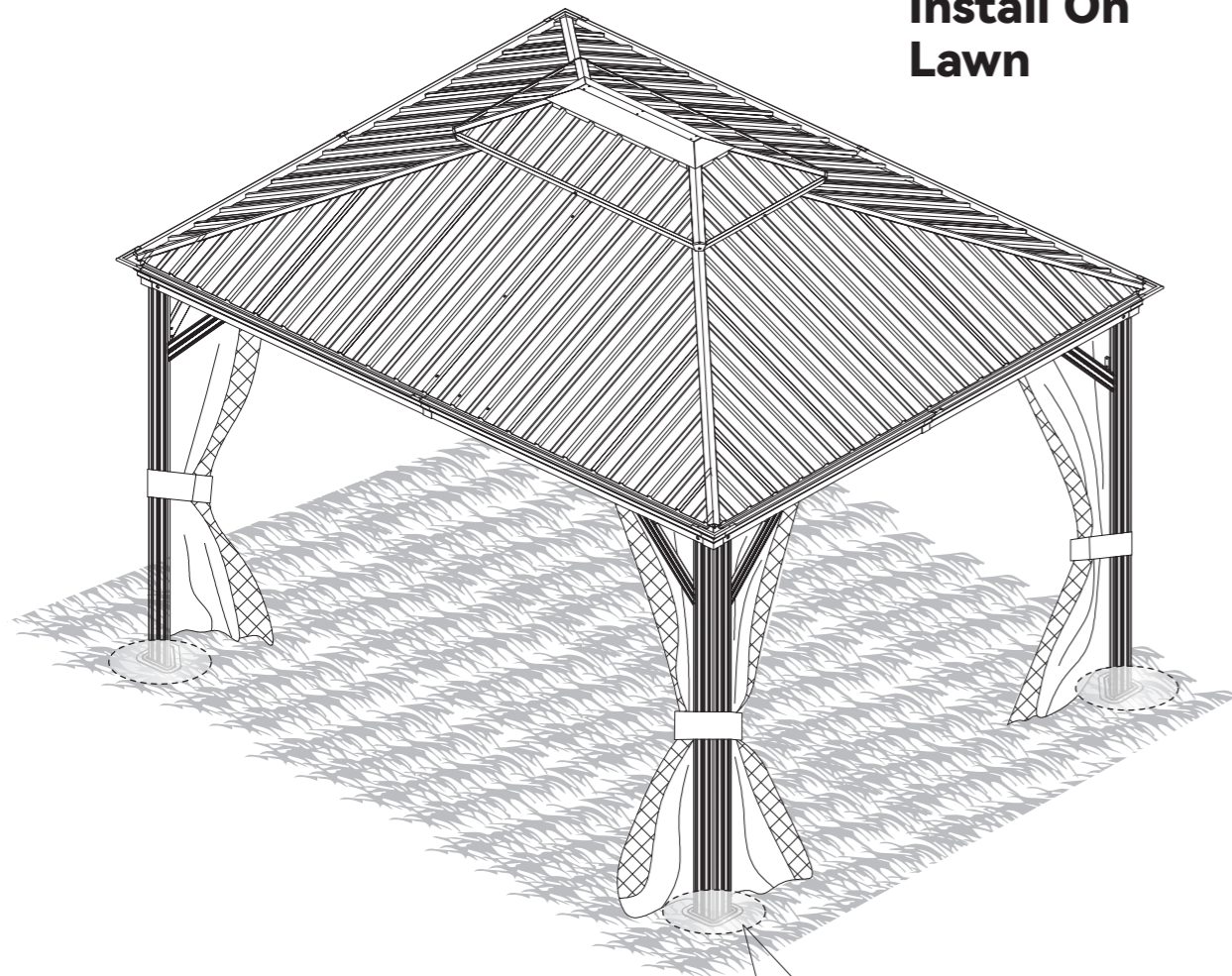
Install On  
LawnCARING FOR  
YOUR ITEM

## USE &amp; CARE INSTRUCTIONS

- Always keep children under close supervision while they are using or around this product. Never leave children unattended.
- This product is intended for domestic outdoor use only.
- Do not light any fires below or near the product.
- Check all nuts and bolts periodically for tightness. When required, tighten them again.
- Do not shake, lean or climb on it.

## CLEANING

FRAME: Wash with mild dish soap and water, rinse with clean water, and allow to air dry. Do not use harsh chemicals or abrasive cleaners, or any other special detergents as they may be harmful to the product's finish!

FABRIC: For best results, clean fabric with a damp cloth and allow to air dry thoroughly. Do not machine wash or dry.

## OFF SEASON

To extend the life of your product, remove all fabric components and store inside when not in use. Do not allow heavy snow accumulation to collect on the roof. Remove with a broom whenever possible to prevent frame failures.

