

Smart Toilet USER MANUAL

Model No: YC368-00101100

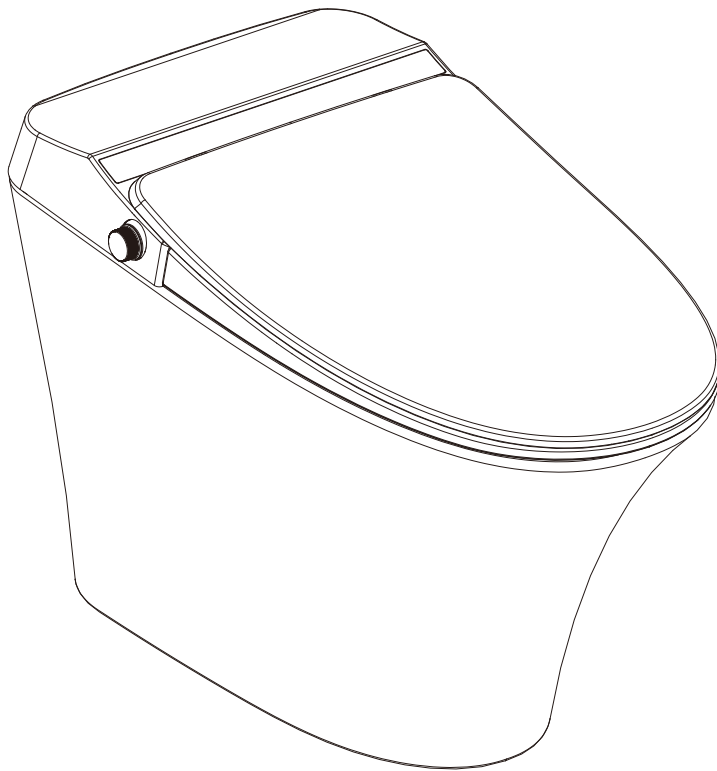

Edition: V 2023.12.24

Dear customers,

Thank you for purchasing our intelligent toilet series products, to ensure safety before using this product, please read this instruction carefully and keep it carefully for reference.

IMPORTANT SAFEGUARDS	02
PRODUCT FUNCTIONS	06
USING GUIDE	07
PACKING LIST	07
PRODUCT SIZE	07
TECHNICAL DATA	08
PRECAUTIONS BEFORE INSTALLATION	09
PRODUCT INSTALLATION METHODS	09
PRODUCT CLEANING AND MAINTENANCE METHODS	11
TROUBLE SHOOTING	12

- Before beginning installation, read all instructions first. Save these instructions for future use.
- This product is subject to standard of UL 1431.

IMPORTANT SAFEGUARDS

When using electrical products, especially when children are present, basic safety precautions should always be followed, including the following:

READ ALL INSTRUCTIONS BEFORE USING

DANGER – To reduce the risk of electrocution:

Do not use while bathing.

1. Do not pour water or detergent on the power plug. It may cause fire, electric shock and other accidents.
Ne versez pas d'eau ou de détergent sur la prise d'alimentation. Cela peut causer un incendie, un choc électrique ou d'autres accidents.
2. Do not bring lit cigarettes or burning species close to the product. It may cause a fire.
N'amenez pas de cigarettes allumées ou d'espèces en feu à proximité du produit. Cela pourrait provoquer un incendie.
3. Please do not continue to use the product when the product fails. Please contact the after-sales service staff for maintenance. When the following situation occurs, please remove the power plug and close the inlet angle valve.

- ① Leakage from the inside of the product line;
- ② The product is unusually hot;
- ③ The product makes an abnormal sound and smell;
- ④ The product is burnt.

If the product is still used in the event of malfunction, it may cause problems such as fire, electric shock, water inflow in the room. (The normal life of this product is six years, the continued use beyond the service life may lead to accidents.)

Veuillez ne pas continuer à utiliser le produit lorsqu'il tombe en panne. Veuillez contacter le personnel du service après-vente pour la maintenance. Lorsque la situation suivante se produit, veuillez retirer la fiche d'alimentation et fermer la vanne d'angle d'entrée.

- ① Fuite de l'intérieur de la ligne de produits;
- ② le produit est anormalement chaud;
- ③ le produit émet un bruit et une odeur anormaux;
- ④ le produit est brûlé.

Si le produit est encore utilisé en cas de dysfonctionnement, il peut causer des problèmes tels qu'incendie, choc électrique, infiltration d'eau dans la pièce (la durée de vie normale de ce produit est de six ans, la poursuite de son utilisation au-delà de la durée de vie peut entraîner des accidents).

4. ① This product belongs to the electrical products, do not put it in places where there is water or the places of high humidity. When used in the bathroom, please install ventilation fan or ventilation port to keep the bathroom in good air circulation. Otherwise, it may cause a fire or electric shock.
② If the power cord is damaged, do not disassemble it yourself and must be replaced by the manufacturer or its service department or relative department.
① Ce produit est un produit électrique, ne le placez pas là où il y a de l'eau ou où l'humidité est élevée. Ne le mettez pas dans des endroits où il y a de l'eau ou des endroits très humides. Lorsqu'il est utilisé dans la salle de bain, veuillez installer un ventilateur ou un orifice de ventilation pour maintenir la salle de bain en bonne circulation d'air. Dans le cas contraire, cela pourrait provoquer un incendie ou un choc électrique.
② Si le cordon d'alimentation est endommagé, ne le démontez pas vous-même et il doit être remplacé par le fabricant ou son service après-vente ou le service concerné.

WARNING – To reduce the risk of burns, electrocution, fire, or injury to persons.

1. Close supervision is necessary when this product is used by, on, or near children or invalids.
2. Use this product only for its intended use as described in this manual. Do not use attachments not recommended by the manufacturer.
3. Never operate this product if it has a damaged cord or plug, if it is not working properly, if it has been dropped or damaged, or dropped into water. Return the product to a service center for examination and repair.
4. Keep the cord away from heated surfaces.

5. Never block the air openings of the product or place it on a soft surface, such as a bed or couch, where the air openings may be blocked. Keep the air openings free of lint, hair, and the like.
6. Never use while sleeping or drowsy.
7. Never drop or insert any object into any opening or hose.
8. Do not use outdoors or operate where aerosol (spray) products are being used or where oxygen is being administered.
9. Connect this product to a properly grounded outlet only. See Grounding Instructions.
10. It is absolutely forbidden to disassemble, repair and transform this product by yourself.
It may cause fire, electric shock and other accidents.
Il est absolument interdit de démonter, réparer et transformer ce produit par vous-même.
Il peut causer un incendie, un choc électrique et d'autres accidents.
12. Only tap water can be used. Otherwise may cause infectious dermatitis and other diseases.
N'utilisez que de l'eau courante. Sinon, cela peut causer une dermatite infectieuse et d'autres maladies.
13. Forbiddance sitting on the seat for a long time, the seat temperature should be adjusted in low-grade, please note that low-temperature burns. The following personnel should set the seat temperature at low-grade when using the toilet.
 - ① Children and elderly people who cannot adjust the temperature to the right degree.
 - ② Patients, persons with disabilities and other people who can not move freely.
 - ③ Lethargic crowd because of taking hypnotics (Such as sleeping pills, cold medicine, etc.) deep drinking and over fatigue.Ne vous asseyez pas sur le siège pendant une longue période, la température du siège doit être ajustée en bas de gamme, veuillez noter les brûlures à basse température. Les personnes suivantes doivent régler la température du siège à un niveau bas lorsqu'elles utilisent les toilettes.
 - ① Les enfants et les personnes âgées qui ne peuvent pas régler la température au bon degré.
 - ② Les patients, les personnes handicapées et les autres personnes qui ne peuvent pas se déplacer librement.
 - ③ Les personnes léthargiques en raison de la prise d'hypnotiques (tels que les somnifères, les médicaments contre le rhume, etc.), de la consommation d'alcool et de la fatigue excessive.
14. Do not forcibly stretch the connecting pipe of the water supply pipe. Otherwise it may cause water leakage.
Ne pas étirer de force le tuyau de raccordement de la conduite d'alimentation en eau. Sinon, cela pourrait provoquer des fuites d'eau.
15. Defecation clean function, a special cleaning function, only allowed to use one time whenever you use the toilet, non-repeated use!
La fonction de nettoyage de la défécation, une fonction de nettoyage spéciale, ne peut être utilisée qu'une seule fois à chaque fois que vous utilisez les toilettes, usage non répété!
16. Do not rely on the seat cover or forcibly press the control panel. Otherwise it may result in malfunction or breakage. Forced application of force may cause seat cover and control panel damage, resulting in personal injury.
Ne vous fiez pas à la housse du siège et n'appuyez pas de force sur le panneau de commande. Sinon, cela pourrait entraîner un dysfonctionnement ou une rupture.
L'application forcée de la force peut endommager la housse du siège et le panneau de contrôle, ce qui peut entraîner des blessures.
17. Do not place containers containing liquid such as vials, cups, cosmetics, pharmaceuticals, etc. or small metal objects on top of the product. Inadvertent entry into the product may result in fire or electric shock.
Ne placez pas de récipients contenant des liquides, tels que des flacons, des tasses, des cosmétiques, des produits pharmaceutiques, etc. Ou de petits objets métalliques sur le dessus du produit. L'entrée accidentelle dans le produit peut entraîner un incendie ou une électrocution.
18. Do not place the product in direct sunlight, otherwise the appearance of products may be aging deformation.
Ne placez pas le produit à la lumière directe du soleil, sinon l'apparence du produit peut vieillir et se déformer.

19. Do not use the toilet to flush expect shit, urinate and toilet paper, or it may cause toilet jam, sewage overflow.
N'utilisez pas la chasse d'eau pour vous attendre à ce que vous chiez, urinez et utilisez du papier toilette, car cela pourrait provoquer un blocage des toilettes ou un débordement des eaux usées.
20. Please do not hit the ceramic to prevent damages that result in leakage.
Veuillez ne pas frapper la céramique afin d'éviter des dommages qui pourraient entraîner des fuites.
21. Please do not use in the environment below 3°C.
S'il vous plaît ne pas utiliser dans un environnement inférieur à 3 °C.
22. When installing the inlet angle valve, please tighten firmly. Otherwise it will lead to water leakage.
Lors de l'installation de la vanne d'angle d'entrée, veuillez la serrer fermement. Sinon, cela entraînera des fuites d'eau.
23. Prevent damage caused by freezing. Freezing can cause damage to the water hose and product interiors and cause water leakage.
Prévenir les dommages causés par la congélation. La congélation peut endommager le tuyau d'eau et l'intérieur du produit et entraîner des fuites d'eau.
24. When traveling for long periods of time or when not in use, please unplug the power plug from the outlet.
En cas de long voyage ou de non-utilisation, veuillez débrancher la prise de courant.
25. This product is only for bathroom, and should not be used for any purposes other than the ones described in this manual. Otherwise maybe cause to fire, electric shock, personal injury or malfunction.
Ce produit est destiné uniquement aux salles de bains et ne doit pas être utilisé à d'autres fins que celles décrites dans ce manuel. Sinon, cela peut causer un incendie, un choc électrique, des blessures Ou l'échec.
26. Do not allow urine and other contaminants to touch the smart toilet. Doing so may cause odor or cause malfunction.
Ne laissez pas l'urine et les autres polluants entrer en contact avec les toilettes intelligentes. Cela peut causer des odeurs ou causer des problèmes.
27. Do not forcibly close the seat and seat cover. It is necessary to avoid the collision of the seat lid and the seat cover when turning them. Otherwise maybe cause malfunction.
Don't clip to the fingers while seat and seat cover switch, otherwise maybe cause bruise.
Ne fermez pas de force les sièges et les housses de siège. Évitez la collision du couvercle de siège et du couvercle de siège lors de la rotation. Sinon, cela peut entraîner un échec. Ne pas couper à Interrupteur de siège et de siège lorsque le doigt, sinon il peut causer des ecchymoses.

SAVE THESE INSTRUCTIONS

DANGER – Improper use of the grounding plug can result in a risk of electric shock.

1. Do not use loose power outlet. It may cause a fire or electric shock.
N'utilisez pas de prise de courant mal fixée. Cela peut causer un incendie ou un choc électrique.
2. Please use the power outlet within the specified conditions (110-120V~, 13A, 60Hz socket).
Do only use 110-120V~ power supply. Using power beyond the socket regulations may cause the socket to heat up and cause a fire.
Veuillez utiliser la prise de courant dans les conditions spécifiées (prise 110-120V ~, 13A, 60Hz). Utilisez seulement l'alimentation électrique de 110-120V~. L'utilisation d'une alimentation électrique non conforme à la réglementation sur les prises peut entraîner un réchauffement de la prise et provoquer un incendie.
3. Do not damage the power cord and seat wire.
 - ① Do not damage, do not process, do not heat;
 - ② Do not force bending, do not curly tied, do not pull;
 - ③ Do not put heavy objects on the power cord and the seat lid connection, ignoring product damage and continuing to use may result in fire, electric shorts and other conditions.
N'endommagez pas le cordon d'alimentation et le fil du siège.
 - ① ne pas endommager, ne pas traiter, ne pas chauffer;
 - ② ne pas forcer la flexion, ne pas lier, ne pas tirer;

- ③ ne pas poser d'objets lourds sur le cordon d'alimentation et le raccord du couvercle du siège, en ignorant les dommages causés par le produit et en continuant à l'utiliser, ce qui pourrait provoquer un incendie, des court-circuits électriques et d'autres problèmes.
4. Please check if grounding is done. A product that is not grounded may cause an electric shock in the event of a malfunction or leakage.
Veuillez vérifier si la mise à la terre est effectuée. Un produit qui n'est pas mis à la terre peut provoquer un choc électrique en cas de dysfonctionnement ou de fuite.
 5. Unplug the power plug when lightning occurs.
Débranchez la prise d'alimentation lorsque la foudre se produit.
 6. For external maintenance, unplug the power plug from the socket for safety reasons. Otherwise maybe get an electric shock.
Pour la maintenance externe, débranchez la prise d'alimentation de la prise pour des raisons de sécurité. Sinon, il peut être électrocuté.

GROUNDING INSTRUCTIONS

This product should be grounded. In the event of an electrical short circuit, grounding reduces the risk of electric shock by providing an escape wire for the electric current. This product is equipped with a cord having a grounding wire with a grounding plug. The plug must be plugged into an outlet that is properly installed and grounded.

DANGER– Improper use of the grounding plug can result in a risk of electric shock.

If repair or replacement of the cord or plug is necessary, do not connect the grounding wire to either flat blade terminal. The wire with insulation having an outer surface that is green with or without yellow stripes is the grounding wire.

Check with a qualified electrician or serviceman if the grounding instructions are not completely understood, or if in doubt as to whether the product is properly grounded.

This product is for use on a nominal 120 V circuit, and has a grounding plug that looks like the plug illustrated in sketch A in below Grounding methods. A temporary adapter, which looks like the adapter illustrated in sketches B and C, may be used to connect this plug to a 2-pole receptacle as shown in sketch B if a properly grounded outlet is not available. The temporary adapter should be used only until a properly grounded outlet (sketch A) can be installed by a qualified electrician. The green colored rigid ear, lug, and the like extending from the adapter must be connected to a permanent ground such as a properly grounded outlet box cover. Whenever the adapter is used, it must be held in place by the screw.

Grounding methods

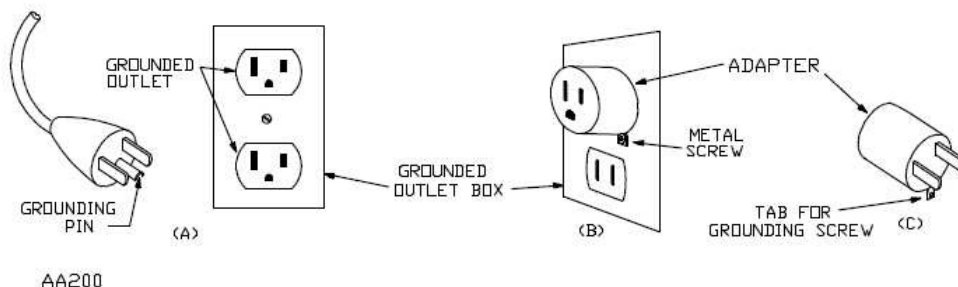

This device complies with Part 15 of the FCC Rules. Operation is subject to the following two conditions:

(1) this device may not cause harmful interference, and (2) this device must accept any interference received, including interference that may cause undesired operation.

Caution: The user is cautioned that changes or modifications not expressly approved by the party responsible for compliance could void the user's authority to operate the equipment.

Note: This equipment has been tested and found to comply with the limits for a Class B digital device, pursuant to part 15 of the FCC Rules. These limits are designed to provide reasonable protection against harmful interference in a residential installation. This equipment generates uses and can radiate radio frequency energy and, if not installed and used in accordance with the instructions, may cause harmful interference to radio communications. However, there is no guarantee that interference will not occur in a particular installation. If this equipment does cause harmful interference to radio or television reception, which can be determined by turning the equipment off and on, the user is encouraged to try to correct the interference by one or more of the following measures:

- Reorient or relocate the receiving antenna.
- Increase the separation between the equipment and receiver.
- Connect the equipment into an outlet on a circuit different from that to which the receiver is connected.
- Consult the dealer or an experienced radio/TV technician for help.

This device contains licence-exempt transmitter(s)/receiver(s) that comply with Innovation, Science and Economic Development Canada's licence-exempt RSS(s). Operation is subject to the following two conditions:

- (1) This device may not cause interference.
- (2) This device must accept any interference, including interference that may cause undesired operation of the device.

L'émetteur/récepteur exempt de licence contenu dans le présent appareil est conforme aux CNR d'Innovation, Sciences et Développement économique Canada applicables aux appareils radio exempts de licence. L'exploitation est autorisée aux deux conditions suivantes:

- (1) L'appareil ne doit pas produire de brouillage;
- (2) L'appareil doit accepter tout brouillage radioélectrique subi, même si le brouillage est susceptible d'en compromettre le fonctionnement.

Product functions

Heated seat, Foot Induction Flush, Power-off Flush, Seat temp. adjustable .

User guidance

Please refer to the below advice when you use the bidet.

1. Turn on the valve.
2. Plug the power cord into the electrical inlet.
3. If power indicator lights on, the bidet seat is ready to use.

Standby Model

In the state of no seated , the seat heating function will be automatically turned off.

Seat temperature ON/OFF

In the state of no seated, long press the knob button for 3 seconds to change the seat temperature heating switch state once. The buzzer beeps once, turn on the seat ring heating; the buzzer beeps twice, the seat ring heating is turned off.

Flushing

1. Power off flush: Short press the metal button to flush once when out of power.
2. Manual flush: Press the metal button to flush manually.
3. Automatic flush: After sitting for more than 10 seconds, it will automatically flush once after leaving the seat.
4. Foot sensing flush: trigger foot sensing when leaving the seat, and flush once. In the state of on seated , the foot sensor would not work.

Packing list

No.	Name	Quantity	No.	Name	Quantity
1	Smart Toilet	1	7	Flange	1
2	User Manual	1	8	G1/2 To G3/4 Angle Valve	1
3	9V Battery Box	1	9	Flange seal ring	1
4	Water Flow Restrictor	1	10	Ceramic side cover	2
5	Flange Mount Kit	1	11	Screw nut	2
6	Ceramic Mount Kit	1			

Product size

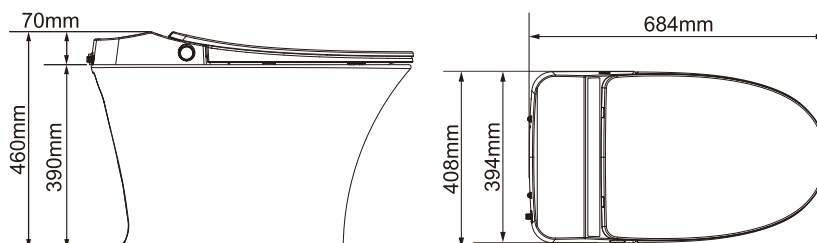

Technical data

Rated voltage	110-120V~	
Rated frequency	60Hz	
Rated power	54W	
Water flow	≥20L/min	
Water supply mode	Directly connected to the channel	
Ambient temperature	About 3°C to 40°C	
Water supply temperature	About 3°C to 35°C	
Water pressure range	Dynamic water pressure 0.14MPa - Static water pressure 0.8MPa	
Safety devices	Electrical leakage protector, seated sensor	
Thermal seat	Seat temperature	Two grades (Room temperature to 37°C)
	Seat heater	45W
	Safety devices	Temperature sensor, temperature fuse
	Switch structure	Damping slowdown

Precautions before installation

1. Installation space

- ① To ensure that there is enough space for installation at the same time, please confirm the door switch does not affect the product's installation. The distance of water inlet pipe to the ground should be more than 150mm.
- ② Before installation, please confirm the location of the outfall and wax seal (For specific location please refer to the logo shown on the right)

2. Installation diagram

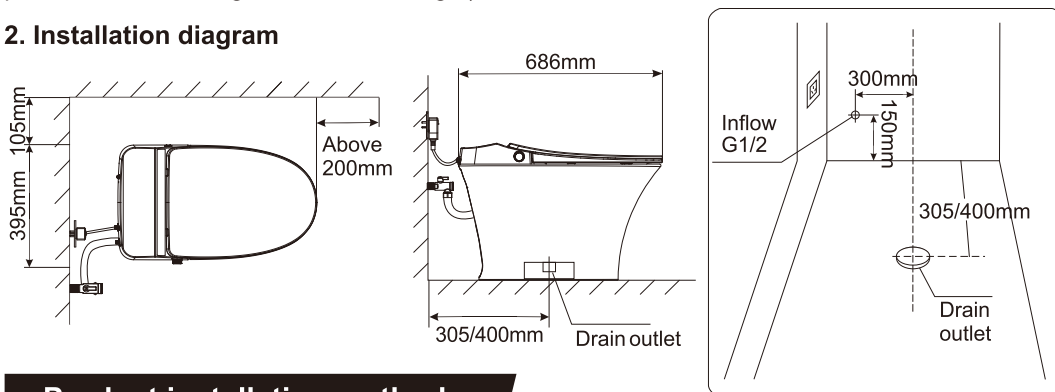

Product installation methods

1. The installation of flanges and ceramics

- ① Place the flange on the sewage outfall, and make a good seal. (See figure 1)
- ② Place the ceramic sewage outfall on the flange. (See figure 2)
- ③ After adjusting the toilet position and installing smoothly, make glass glue seal between the toilet body and the ground.

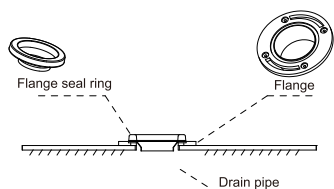

Figure 1

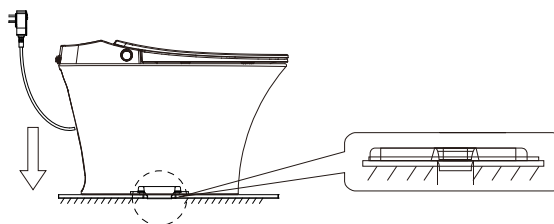
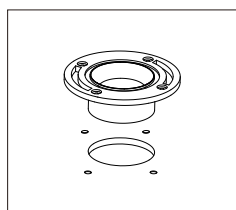
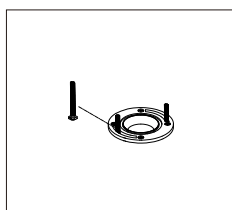

Figure 2



1. According to the position of the four screw holes of the flange, make four holes around the floor drain outlet, and drive in expansion screws to fix the flange.



2. Insert the toilet mounting bolts into the grooves of the flange, then align the flange with the sewage outlet and tighten the screws to fix it.

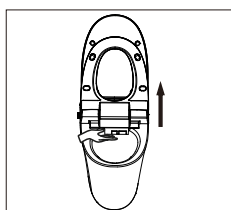

3. Separate the electronic seat cover with the ceramic by holding the upper cover with both hands and lift it up.

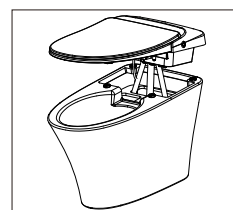

4. Lift the cover up a little from the back of the toilet, so that you can loosen the braided tube and wires behind the electronics cover.

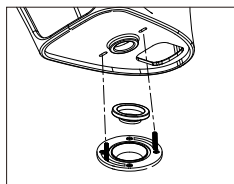

5. Put the flange sealing ring on the flange, and then align the mounting bolts through the mounting holes at the bottom of the toilet.

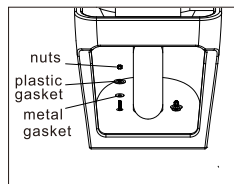

6. Put metal gaskets, plastic gaskets and nuts on the bolts in sequence, and then tighten the screws to fix them after the installation is stable. (Please process this installation from the top of the toilet bowl)

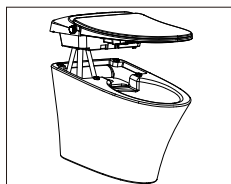

7. Reinstall the braided tube as in step 4 and connect the wires.

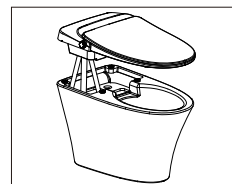

8. Adjust the position of the upper cover, align it with the 4 installation holes of the ceramic body, press down firmly, and the installation is complete.

2. Connect the water supply pipe

⚠ Before installing the valve, please drain all the impurities and sewage in the pipes. (Discharge the water for 1 to 2 minutes)

- ① When the water supply valve is closed, remove the old angle valve and replace it with the machine-equipped angle valve. Please use the supply hose included. Do not use the old one.
- ② Connect the supply line with inlet valve.
- ③ After the machine is installed, open the knob to detect no leakage at A, B, C.
- ④ Inspection is correct, plug in the power supply, press the "manual flush" button to confirm the siphon effect of sewage.

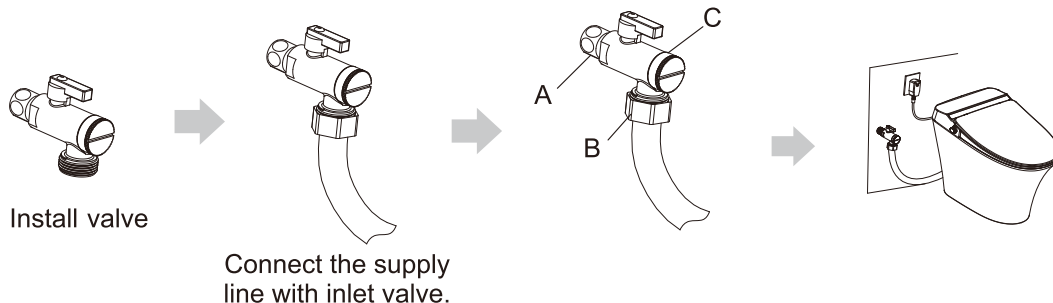

3. Battery Installation

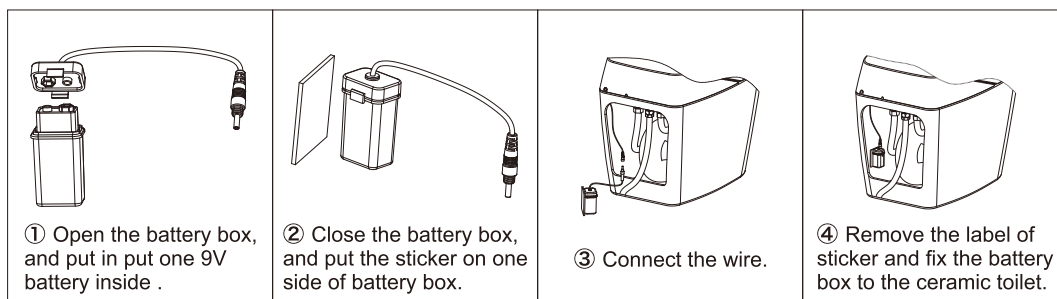

Product cleaning and maintenance methods

Warning: waterproof toilet cleaning precautions

- Do not clean the product with your hands in case of damage or failure, to avoid secondary failure.
- Do not use hydrochloric acid detergent, thinner, bleach, benzene or strong detergent to clean the surface of the toilet. Do not allow pesticides, air fresheners and deodorants to stick to the toilet bowl.
- **The body discoloration, cracking and damage caused by the use of the above-mentioned reagents, even within the warranty period also need to paid the services.**

1. Filter cleaning

When the water supply valve is closed, cut off the machine water supply, do the following operation.

- ① Shut off inlet valve by clockwise rotation
- ② Unscrew water filter by a coin or slot screwdriver
- ③ Take out water filter and clean by toothbrush or other clensers. Mount water filter back after cleaning.
- ④ Turn on inlet valve by counterclockwise rotation

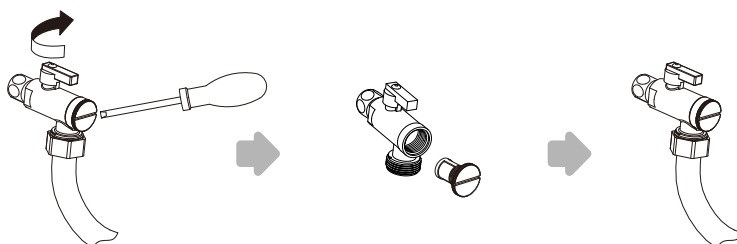

Toilet appearance cleaning method diagram

- ① Please unplug the power plug from the socket or press the reset button on the leak protection.
- ② Use a soft cloth or sponge stained with neutral detergent to clean the machine.
- ③ Wipe the whole machine with cotton cloth after cleaning.

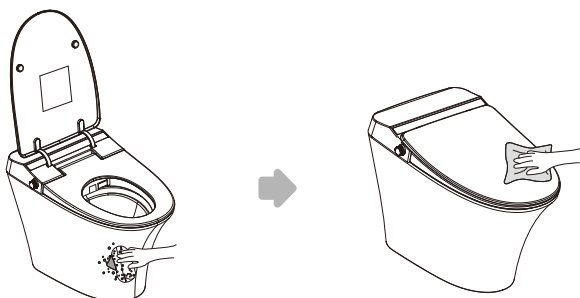

3. Seat toilet management methods in winter

In order to prevent freezing in winter, please follow the following methods to manage.

- ① Check whether the power plug is properly inserted into the socket.
- ② When the bathroom has no heating device, please use cloth to wrap connecting pipes or other insulating materials for insulation.

• **Note:**

Please tighten the filter firmly, otherwise it may cause water leakage.

Do not grab the filter net too strongly as it may distort or rupture.

When blockage blocks the filter, the pressure of the flushing water may not be enough, so please clean the toilet regularly once in three months.

We recommend that you do not use detergent when cleaning. Clean it directly with tap water.

Trouble shooting

Problems		Check	Handling
Functions does not work at all.		The seat sensing area uses cloth cover, mat and other items.	Please remove the cloth cover, mat and other items.
		Power is cut.	Please wait for power recovery.
		Socket is loose or poor contact.	Plug in, ensure good power supply.
		Whether the power reset button is pressed.	Please press the power button on the toilet.
Toilet Seat	The heated seat is not heating.	Thermal seat's heating strength is set in the low or off state.	Please reset the seat temperature by "button description" on the remote control.
		The toilet is set in the energy-saving state.	Please exit energy-saving state.
		Whether the power outage.	Please wait for power recovery.

Thank you for choosing us

The company is committed to product development and improvement. If there is any difference between the original manual and the improved one, please read the corresponding version of the manual. We apologize for any inconvenience.

尺寸：18.3x25.7cm

材质：封面和内页材质：80g双胶纸

装订工艺：骑马钉