

ASSEMBLY INSTRUCTION



ASSEMBLY TIPS:

1. Remove hardware from box and sort by size.
2. Please check to see that all hardware and parts are present prior to start of assembly.
3. Please follow attached instructions in the same sequence as numbered to assure fast & easy assembly.



Warning!



1. Don't attempt to repair or modify parts that are broken or defective. Please contact the store immediately.
2. This product is for home use only and not intended for commercial establishments.

ASSEMBLY TIME PER UNIT: 10MINUTES



PARTS IDENTIFICATION

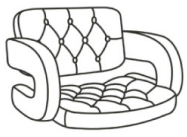
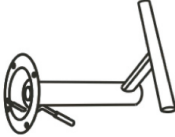
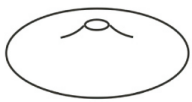

NOTE: QUANTITIES SHOWN ARE FOR ONE CHAIR

A-SEAT  1PC	B-FOOTREST  1PC
C-BASE  1PC	D-GAS CYLINDER  1PC
E-COVER RING  1PC	

HARDWARE PACKAGE

NO	DESCRIPTION	FIGURE	Q'TY
1	BOLTS M6x16mm		4PCS
2	ALLEN WRENCH M6		1PCS

STEP 1

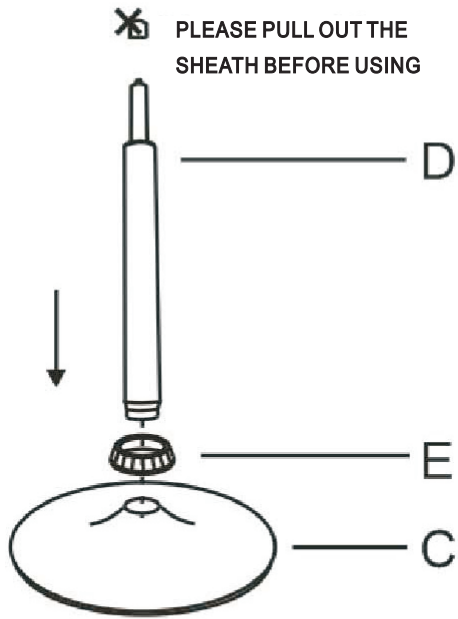

STEP 2

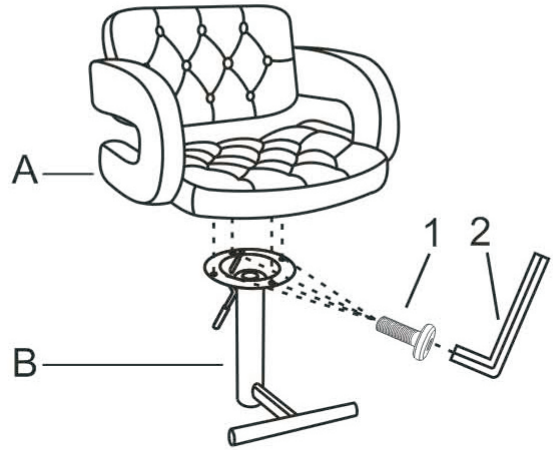

STEP 3

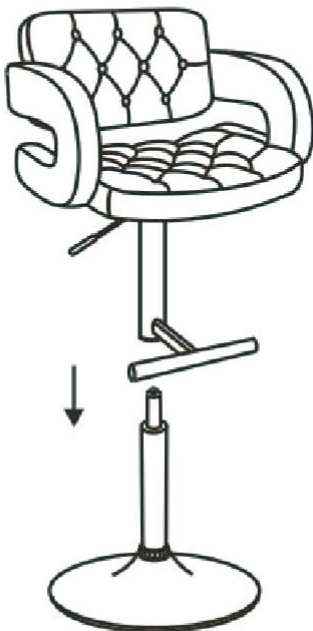

STEP 4

