

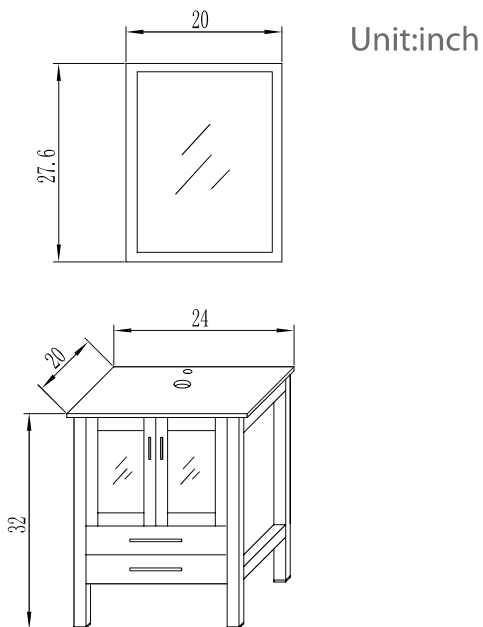

INSTALLATION INSTRUCTIONS

*The vessel set is not included







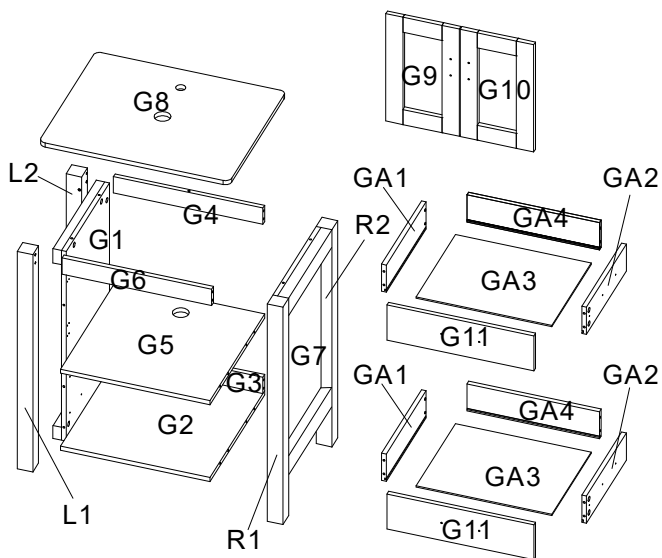

















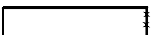

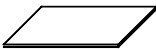



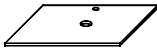

DIMENSIONS



ASSEMBLY DIAGRAM



PARTS LIST

PARTS LIST			Ga2		2
NO.	DESCRIPTION	QTY	Ga3		2
L1		1	Ga4		2
L2		1	HARDWARE LIST		
R1		1	NO.	DESCRIPTION	QTY
R2		1	A	 CAM LOCK	53
G1		1	B	 CAM SCREW	53
G2		1	C	 CAM LOCK COVER	53
G3		1	D	 WOODEN DOWEL	28
G4		1	E	 SCREW	46
G5		1	F	 HINGE	4
G6		1	G	 HASCREW(φ4x18mm)	8
G7		1	I	 HANDLE	2
G8		1	J	 HANDLE	2
G9		1	K	 (φ3.5x35mm)	2
G10		1	L	 (φ6x30mm)	2
G11		2	M		4
GA1		2	N		2

CAUTION: Please confirm the parts list before installtion

YOU MAY NEED (NOT SUPPLIED)

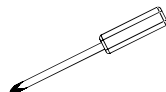
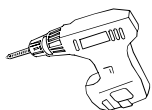

INSTALLATIONS

STEP 1

HARDWARE LIST	
B	22PCS

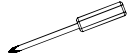
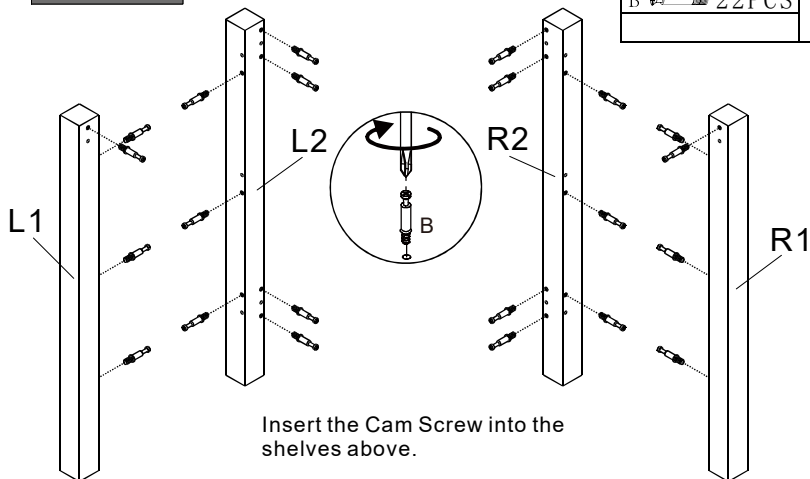
STEP 2

HARDWARE LIST	
A	12PCS
C	12PCS
D	14PCS

STEP3

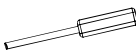
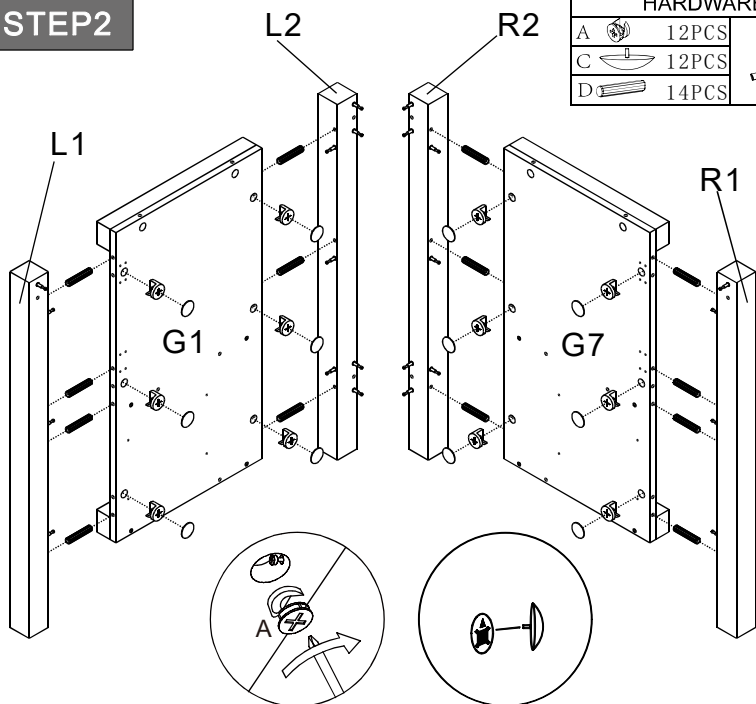
● Insert the Cam Screw into the shelves above.

HARDWARE LIST		
B		8PCS
		

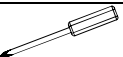

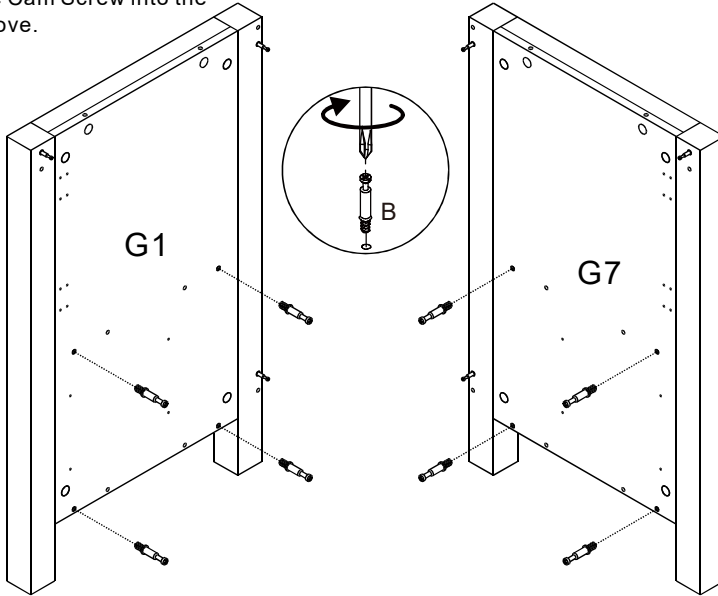

STEP4

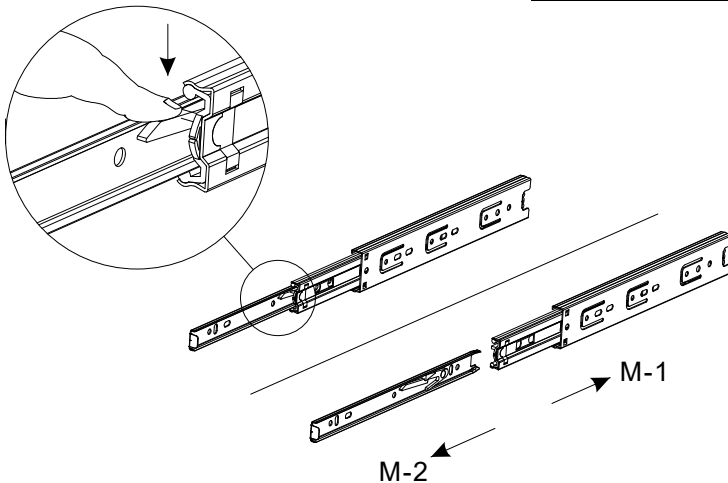
HARDWARE LIST		
M		4PCS



● Press the button and extend the slide slowly. Then separate it with the release latch. Repeat these steps for the other slides.

STEP5

HARDWARE LIST	
E	8PCS
	
	



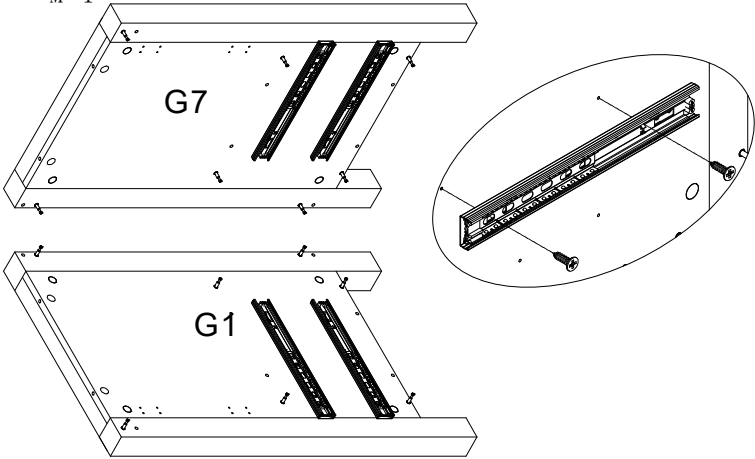

4PCS M-1



● Insert the screws to connect the slides (M-1) to the shelves.



STEP6

HARDWARE LIST	
B	23PCS
	
	

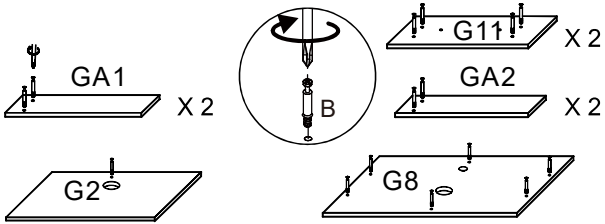
● Insert the Cam Screw into the shelves above.



STEP7

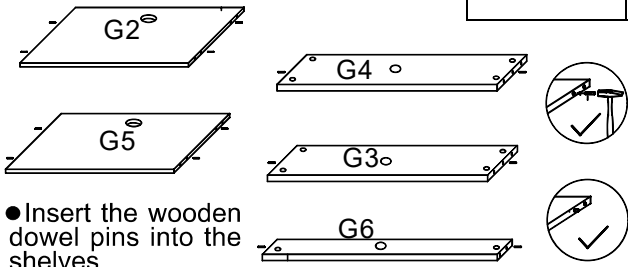

HARDWARE LIST	
D	14PCS
	
	

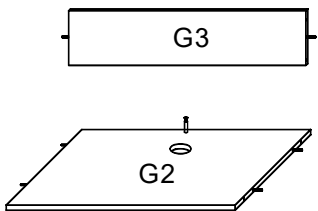

● Insert the wooden dowel pins into the shelves.

STEP8



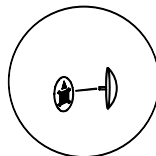
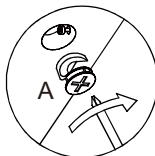

HARDWARE LIST		
A		1PCS
C		1PCS

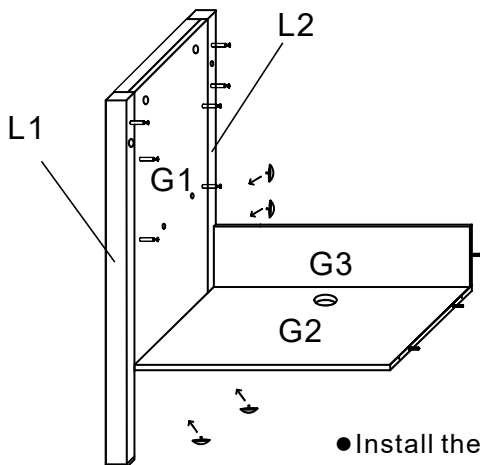

● Insert shelves G3 downwards to their corresponding positions. Then tighten the cam lock with the cover

STEP9



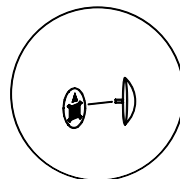
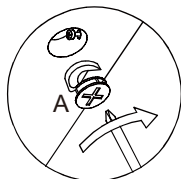

HARDWARE LIST		
A		4PCS
C		4PCS

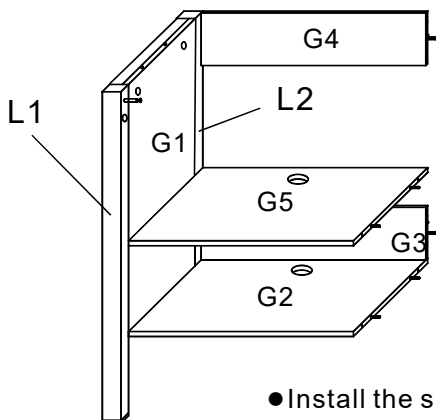

● Install the shelves #G2.#G3 on the G1 and L2.

STEP10



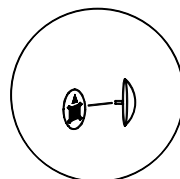

HARDWARE LIST		
A		4PCS
C		4PCS



● Install the shelves #G4.#G5 on the G1 and L2.

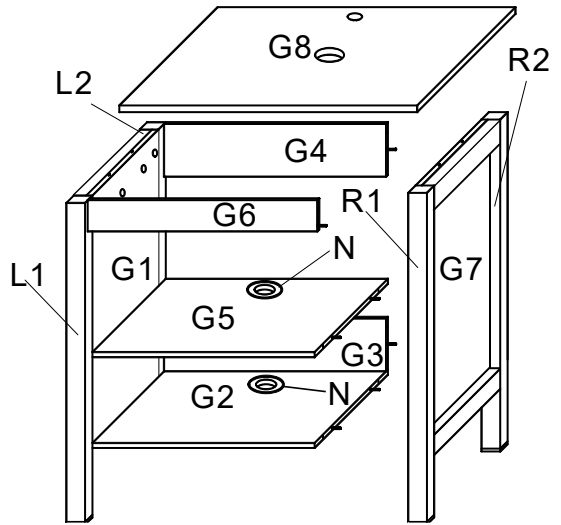
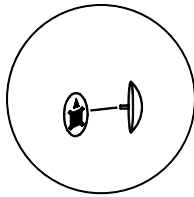
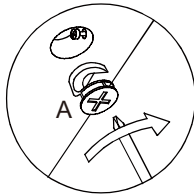

STEP11

HARDWARE LIST	
A 	16PCS
C 	16PCS



- Install shelves #G8, #G6, G7 (#R1, #R2) in order. Then tighten the carriage with the cover.

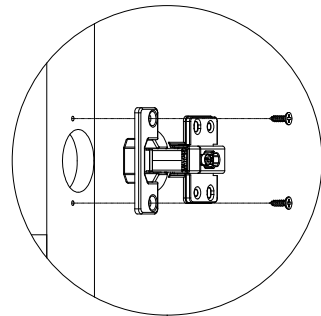
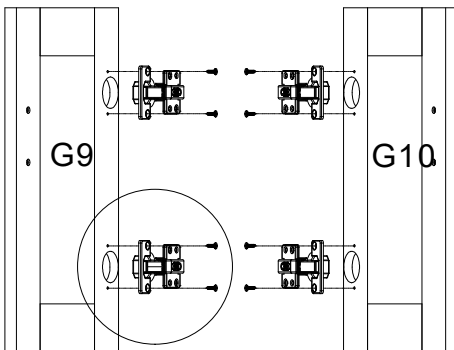

STEP12

HARDWARE LIST	
E 	8PCS
F 	4PCS



- Apply the screws to fix the hinges on the shelves #G9 #G10.

STEP13



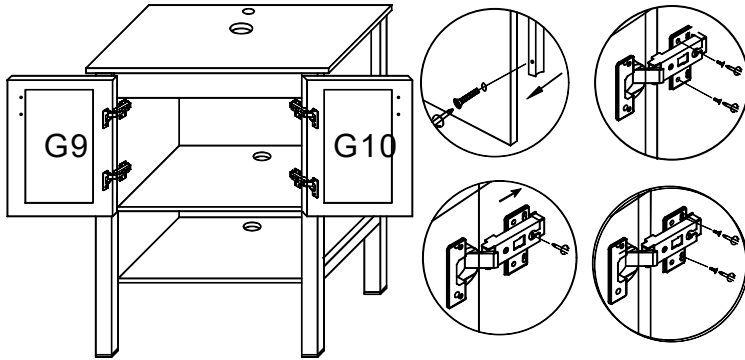
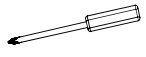

HARDWARE LIST		
E		16PCS
G		4PCS
I		2PCS



- Use E SCREWS to connect the hinge bracket to the cabinet.

Note: see step 17 to adjust the door's position.

STEP14

HARDWARE LIST		
A		16PCS
C		16PCS
G		4PCS
I		2PCS

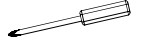

- Install shelves #GA1、GA2、GA3、GA4 in order, and then #G11.

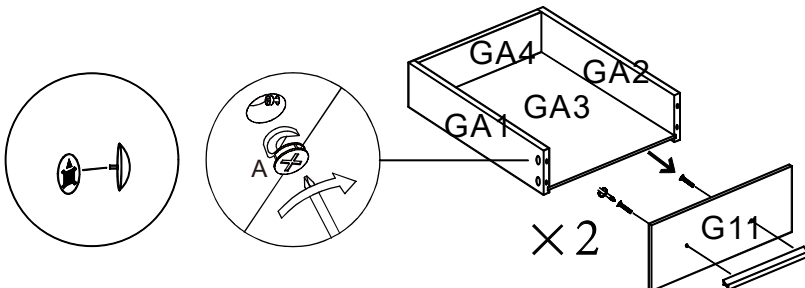
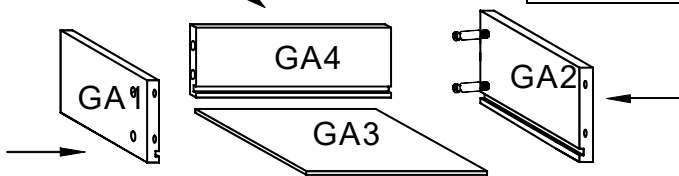

- Use G SCREWS to fix the handle on the shelf #G11. Repeat for the second drawer.

STEP15

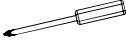
HARDWARE LIST	
E	 12PCS
	

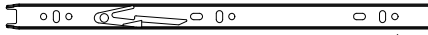

4PCS M-2

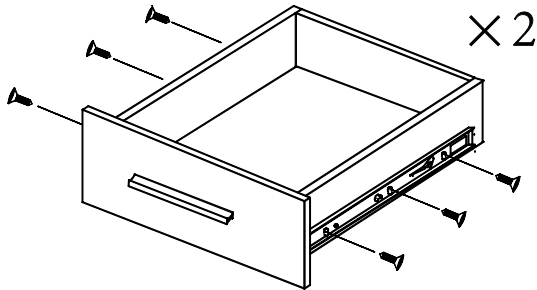

- Insert the screws to connect the slides(M-2) to the drawer side.

STEP16

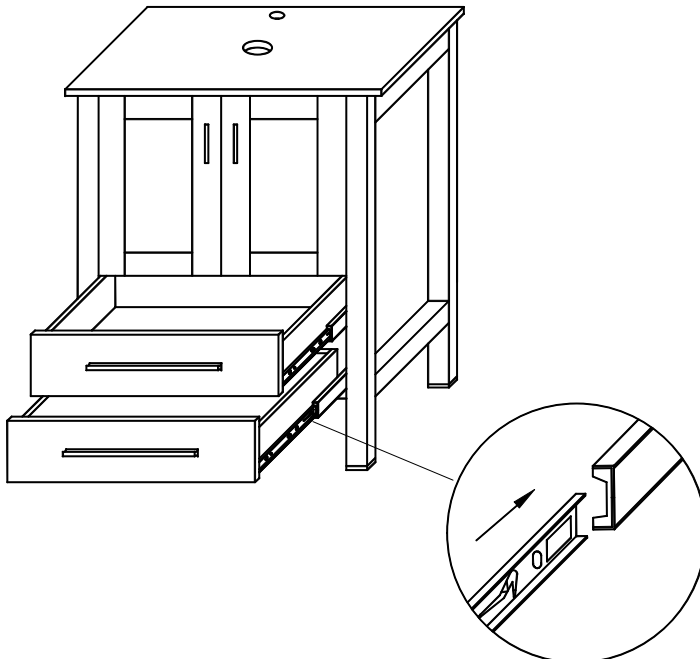

- Connect the drawer to the slide inside the cabinet. Then slide the drawer in and out to ensure smooth operation.

STEP 17

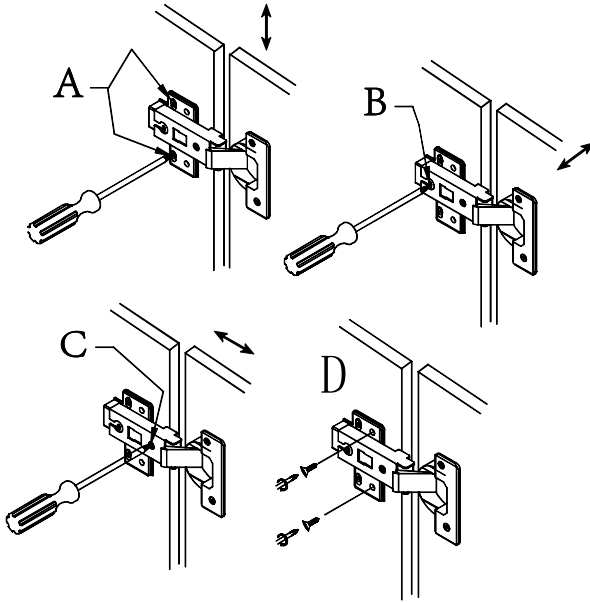

A.height adjustment
 B.depth adjustment
 C.side to side adjustment
 D.after adjustment A/B/C,
 tighten screws.

To ensure proper cabinet alignment, refer to the above illustrations for instructions about adjusting the cabinet height, depth and lateral movement.

STEP 18

HARDWARE LIST	
L 	2PCS

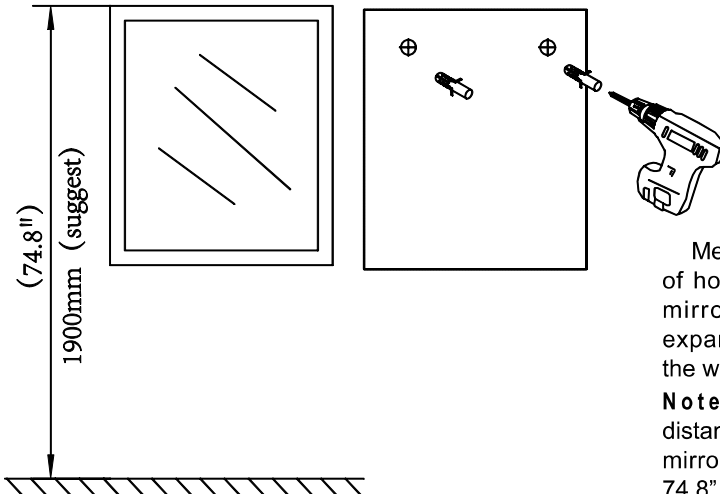

Measure the distance of hole on the back of mirror and insert the expansion anchor into the wall.

Note: Appropriate distance from the top of mirror to the ground is 74.8".

STEP19

HARDWARE LIST	
K  2PCS	

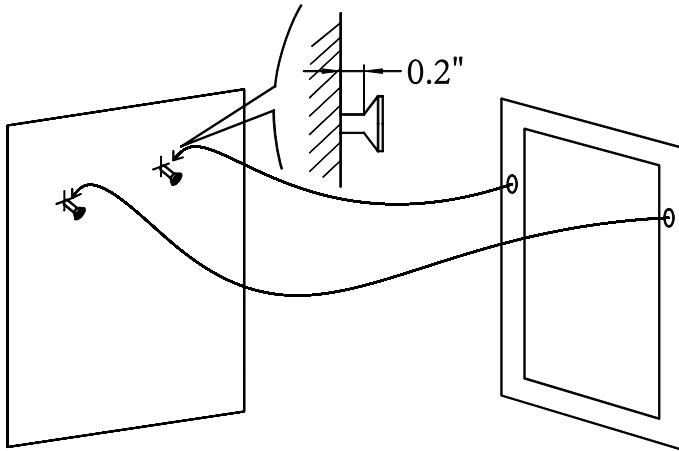

Insert the expansion into the anchor. Leave about 5mm (0.2") clearance for the mirror. Then connect the mirror.

STEP20

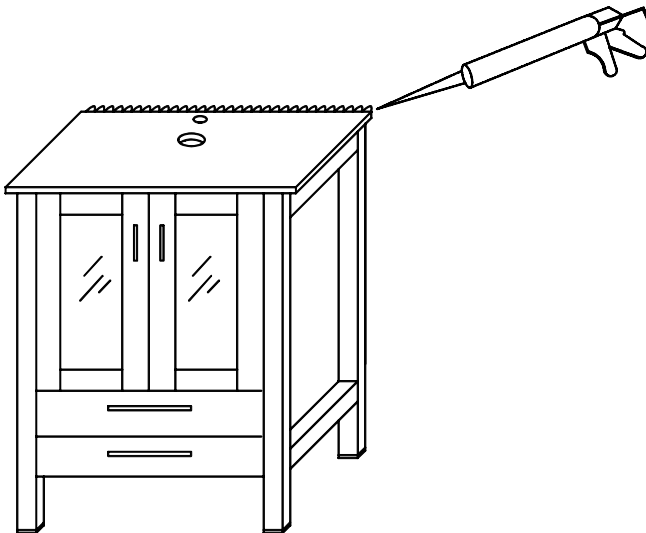

To help prevent mildew, apply sealant to the space between the wall and the edge of the cabinet.

CARE AND CLEANING

1. Many cleansers contain abrasive and chemical substance which is not suitable for cleaning stainless steel, enamel, plating or plastic products. You may use mild cleansers or soaps to clean the surfaces. Wipe any splashes of cleaner solutions from the surface with a clean soft cloth.
2. Maintain ventilation in the bathroom and separate the dry area from the damp one if conditions permit. Try to open the door and windows of the bathroom to maintain adequate ventilation.
3. This cabinet is built to withstand normal bathroom humidity. For best results, keep this vanity dry and take necessary steps to minimize bathroom humidity by opening windows and doors and using the exhaust fan (if available).
4. To maintain the cabinet door, clean and wipe the door regularly with a soft cloth. Wipe condensation with a dry, soft cloth. Keep away from fires and high temperatures.
5. Please do not sit, lean or step on the basin cabinet.

FEEDBACK



Thank you very much for purchasing from us.

We have always been trying to provide the best service and reliable products for every customer.

However, accident may happen sometimes, please contact us to resolve any issue before leaving a negative feedback.

Many thanks and welcome to our shop again!

Contact number:

E-mail: